



# ***NFPA Air Cylinders***



## Cylinder Construction

Head and cap are machined from solid aluminum bar stock and black anodized for corrosion resistance.

Tie rods are 100,000 psi minimum yield steel for maximum holding power. Threads are rolled for durability.

Pressure rating: 250 psi max.  
 Temperature limits: -10°F to +165°F.

Lubrication is a high performance synthetic grease with microscopic PTFE particles in suspension.

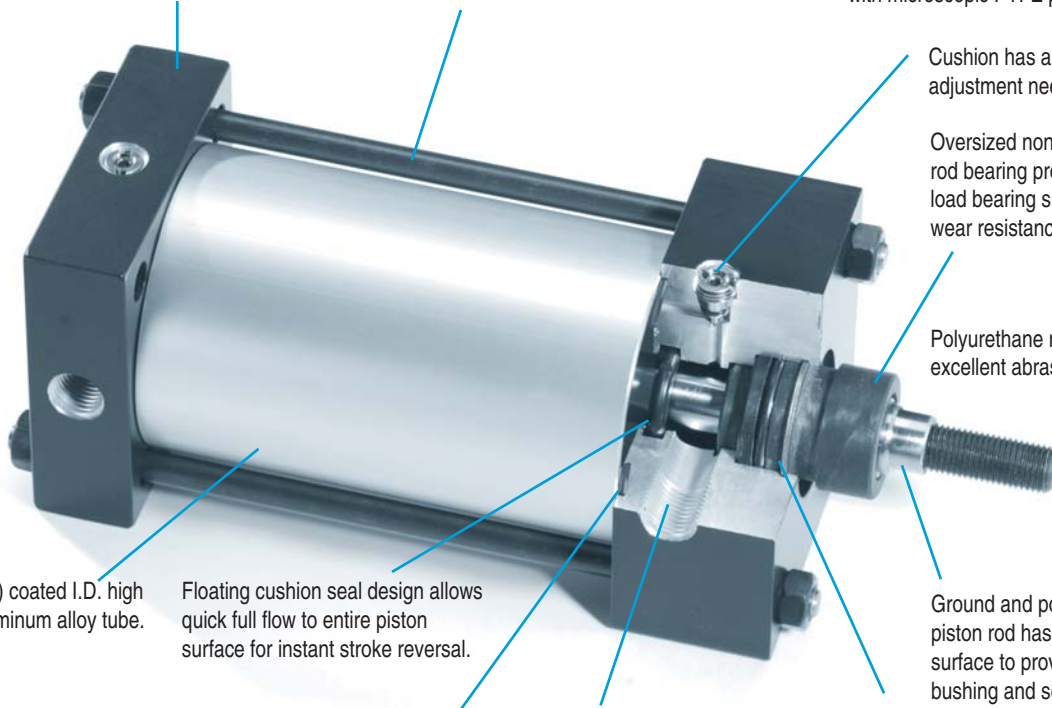

Cushion has a flush, retained adjustment needle.

Oversized nonmetallic, composite rod bearing provides maximum load bearing support and superb wear resistance for high cycle life.

Polyurethane rod wiper has excellent abrasion resistance.

Ground and polished high strength steel piston rod has hard chrome plated surface to provide maximum cycle life for bushing and seals.

Hard (60 Rc) coated I.D. high strength aluminum alloy tube.

Floating cushion seal design allows quick full flow to entire piston surface for instant stroke reversal.

Solid aluminum alloy piston is strong, light weight and carries a wide graphite filled PTFE wear band to support maximum load conditions.

Compression type tube seals are reusable.

Port design allows full flow for optimum cylinder operation.

Bearing retainer ring allows bearing cartridge to be removed without disassembly of cylinder.

## Quick Reference to Mounting Styles

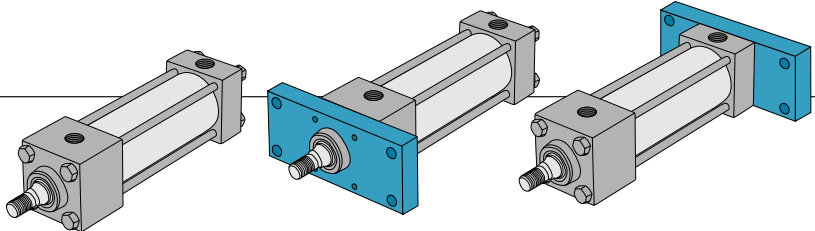

MXO - Basic Cylinder  
 Order Code XO

MF1 Head Rectangular  
 Flange - Order Code F1

MF2 Cap Rectangular  
 Flange - Order Code F2

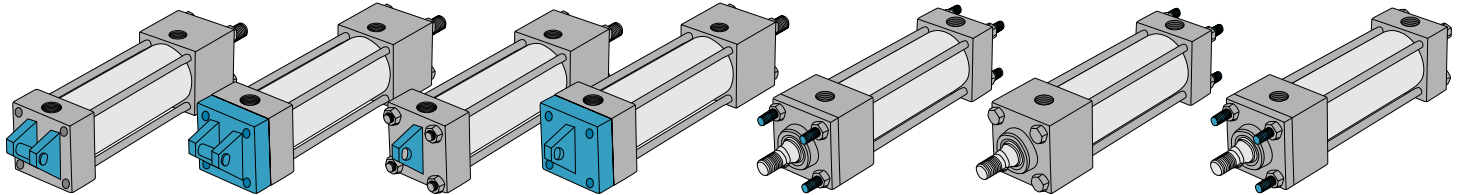

MP1 Fixed Clevis  
 Order Code P1

MP2 Detachable Clevis  
 Order Code P2

MP3 Fixed Eye  
 Order Code P3

MP4 Detachable Eye  
 Order Code P4

MX1 Extended Tie Rods  
 Both Ends - Order Code X1

MX2 Extended Tie Rods  
 Cap End - Order Code X2

MX3 Extended Tie Rods  
 Head End - Order Code X3

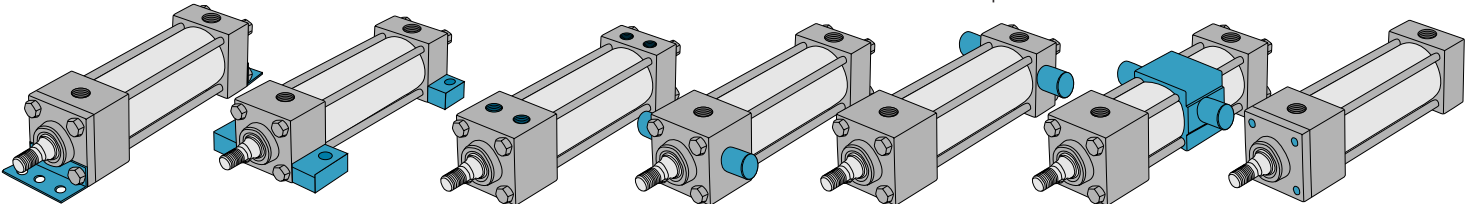

MS1 Angle Mount  
 Order Code S1

MS2 Side Lug Mount  
 Order Code S2

MS4 Bottom Tapped  
 Order Code S4

MT1 Head Trunnion  
 Order Code T6

MT2 Cap Trunnion  
 Order Code T7

MT4 Mid Trunnion  
 Order Code T8

Sleeve Nut Mount  
 Order Code SN

Note: The fields in the model number below this line must be filled.

This field can be blank.

## Model Number

3 2 X O - 0 6 A 1 E C - C T E - A D 0 1 A

### Cylinder Bore

- 15 = 1-1/2
- 20 = 2
- 25 = 2-1/2
- 32 = 3-1/4
- 40 = 4
- 50 = 5
- 60 = 6

### Order Code

#### NFPA Mounting

- XO ... MXO = Basic cylinder - no mount
- F1 ... MF1 = Head rectangular flange
- F2 ... MF2 = Cap rectangular flange
- P1 ... MP1 = Fixed clevis
- P2 ... MP2 = Detachable clevis
- P3 ... MP3 = Fixed eye
- P4 ... MP4 = Detachable eye
- T6 ... MT1 = <sup>1</sup> Head trunnion
- T7 ... MT2 = <sup>1</sup> Cap trunnion
- T8 ... MT4 = <sup>1</sup> Mid trunnion
- X1 ... MX1 = Extended tie rods both ends
- X2 ... MX2 = Cap end tie rods
- X3 ... MX3 = Head end tie rods
- S1 ... MS1 = Angle mount
- S2 ... MS2 = Side lug
- S4 ... MS4 = Bottom tapped, flush mount
- SN - = Sleeve nut

### Full inches of stroke

- 00 = 0"
- 01 = 1"
- 02 = 2"
- 03 = 3"
- 48 = 48"

### Fractional inches of stroke

- A = 0"
- B = 1/16"
- C = 1/8"
- D = 3/16"
- E = 1/4"
- F = 5/16"
- G = 3/8"
- H = 7/16"
- I = 1/2"
- J = 9/16"
- K = 5/8"
- L = 11/16"
- M = 3/4"
- N = 13/16"
- O = 7/8"
- P = 15/16"

### Rod End Thread Code

- 1 = Style #1 Standard male
- 2 = Style #2 Optional male
- 3 = Style #3 Optional female

### Port Size & Position Code

Position	1	2	3	4
L = 1/8 NPT	B	H	N	T
M = 1/4 NPT	C	I	O	U
N = 3/8 NPT	D	J	P	V
O = 1/2 NPT	E	K	Q	W
P = 3/4 NPT	F	L	R	X

### Length Extensions (Leave blank if not required)

- AD = Rod thread total "A" Dim (Must specify)  
Example = AD01A (Full & fractional length)
- CD = Shaft total "C" Dim (Must specify)  
Example = CD02A (Full & fractional length)
- AC = Total "A" & "C" Dim combined (Must specify)  
Specify "A" Dim first, then "C" Dim.  
Example = AC01A02A (Full & fractional length)

### Magnet

- N = No magnet
- E = Magnet sensing

### Options

- XX = No options
- BF = Bumper, head end only<sup>1</sup> (pg. 10)
- BR = Bumper, cap end only<sup>1</sup> (pg. 10)
- CT = Composite cylinder tube
- DR = Double rod (pg. 4)
- MR = Male rod stud with "KK" thread (pg. 10)  
Available only for Style #3 Rod End
- SB = Silent seal bumpers (allows use of air cushions - pg. 10)  
(150 psi max., 200°F max.)
- SR = Stainless steel piston rod
- ST = Stainless steel tie rods
- VS = Viton® seals (385°F max.)
- WS = Metallic rod scraper

### Combination Options

- BB = Bumpers, head and cap<sup>1</sup>.
- CR = Composite tubing and stainless rod.
- CS = Composite tubing and stainless tie rods.
- CU = Composite tubing, stainless rod and tie rods.
- DM = Double rod and male rod stud (Head end only).
- DS = Double rod and stainless rod.
- DT = Double rod and stainless tie rods.
- DU = Double rod, stainless rod and stainless tie rods.
- SS = Stainless steel rod and tie rods.
- WD = Composite tubing, stainless rod, stainless tie rods, and metallic scraper.
- WE = Composite tubing, stainless rod, stainless tie rods, metallic scraper and Viton seals.
- WV = Metallic rod scraper and Viton seals.

### Consult factory for additional combination options.

<sup>1</sup>OAL increases 0.062 per end.

Piston travel is minimum of specified stroke.

### Adjustable Air cushions (St'd position Head and Cap = C)

Position	1	2	3	4
No Cushions	A	A	A	A
Head & Cap	B	C	D	E
Head only	F	G	H	J
Cap only	K	L	M	N

### Standard Ports, Diameters, and Rod Threads

Code	Bore	NPT	St'd Port		Rod	Style #1 St'd Male Thread	Style #2 Opt. Male Thread	Style #3 Opt. Female thread
			Position	Code				
15	1-1/2	3/8	D		.625	7/16-20	1/2-20	7/16-20
20	2	3/8	D		.625	7/16-20	1/2-20	7/16-20
25	2-1/2	3/8	D		.625	7/16-20	1/2-20	7/16-20
32	3-1/4	1/2	E		1.000	3/4-16	7/8-14	3/4-16
40	4	1/2	E		1.000	3/4-16	7/8-14	3/4-16
50	5	1/2	E		1.000	3/4-16	7/8-14	3/4-16
60	6	3/4	F		1.375	1-14	1 1/4-12	1-14

(Viton® is a registered trademark of DuPont Corp.)

## Sizing Guide

**Table 1 – Extend Force (pounds)**

Bore	Piston Area	Pressure											
		40	50	60	70	80	90	100	125	150	175	200	250
1-1/2"	1.77	71	88	106	124	141	159	177	221	265	309	353	443
2"	3.14	126	157	188	220	251	283	314	393	471	550	628	785
2-1/2"	4.91	196	245	295	343	393	442	491	614	736	859	982	1228
3-1/4"	8.30	332	415	498	581	664	747	830	1037	1244	1452	1659	2075
4"	12.57	503	628	754	880	1005	1131	1257	1571	1885	2199	2513	3143
5"	19.63	785	982	1178	1374	1571	1767	1963	2454	2945	3436	3927	4908
6"	28.27	1131	1414	1696	1979	2262	2545	2827	3534	4241	4948	5655	7067

**Table 2 – Retract Force Deduction (pounds)**

Rod	Rod Area	Pressure											
		40	50	60	70	80	90	100	125	150	175	200	250
.625	.307	12	15	18	21	25	28	31	38	46	54	61	76
1.000	.785	31	39	47	55	63	71	79	98	118	137	157	196
1.375	1.458	59	74	89	104	119	134	148	186	223	260	297	371

### Standard port and air cushion adjustment positions

Ports are in position #1 both ends; cushion adjustments are in position #2 both ends.

**Optional position** Air cushion adjustment can be located on same surface as standard size port on 2" bore and larger. For 1-1/2" bore or larger ports, consult factory.

Trunnion Mount ports &/or air cushions at Position 1 or 3 only.

### Approximate Cylinder Weights (pounds)

Bore	Rod	X0 S4 SN	F1 F2 S2	P2 P4	T1 T2 T4	P1, P3, X1, X2, X3, S1	Per Inch Stroke by Tube Material		
							Aluminum	Steel	Composite
1-1/2"	.625	2.10	2.70	3.20	2.60	2.30	0.24	0.36	0.23
2"	.625	2.70	3.70	4.10	3.10	2.80	0.30	0.45	0.28
2-1/2"	.625	3.60	5.00	5.50	4.00	3.70	0.30	0.49	0.28
3-1/4"	1.000	7.10	10.30	11.50	7.50	7.50	0.50	0.74	0.47
4"	1.000	9.30	14.00	15.50	9.90	9.90	0.60	0.99	0.56
5"	1.000	13.00	20.00	20.10	13.70	13.30	0.60	0.99	0.56
6"	1.375	22.00	32.00	35.00	23.00	23.00	0.90	1.33	0.83

## Basic Cylinder

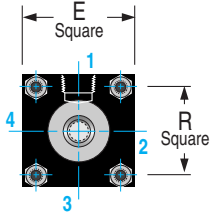

Head End View  
1-1/2" thru 5" Bores

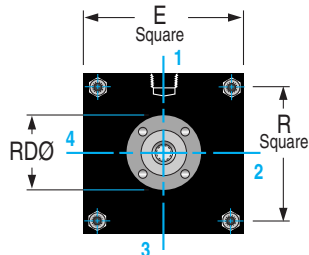

Head End View  
6" Bore

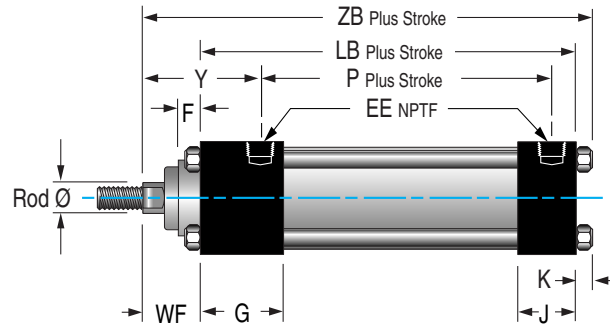

## Double Rod Cylinder

Use option code "DR" for double rod cylinder available with the following NFPA mounts:  
 MXO, MF1, MT1, MT4, MX1, MX3, MS1, MS2, MS4 or non-NFPA SN mount.

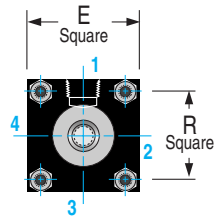

Head End View  
1-1/2" thru 5" Bores

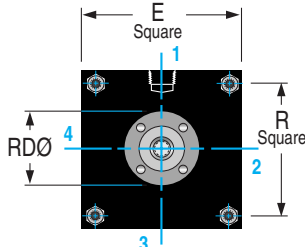

Head End View  
6" Bore

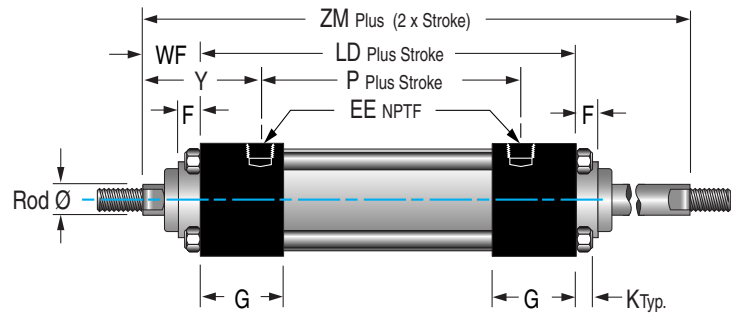

### Basic Dimensions for Single or Double Rod Cylinders (inches)

Bore	Rod	E	EEStd	F	G	J	K	LB	LD	P	R	RD	WF	Y	ZB	ZM
1-1/2"	.625	2.000	3/8	.000	1.500	1.000	.250	3.625	4.125	2.250	1.428	N/A	1.000	1.938	4.875	6.125
2"	.625	2.500	3/8	.000	1.500	1.000	.313	3.625	4.125	2.250	1.838	N/A	1.000	1.938	4.938	6.125
2-1/2"	.625	3.000	3/8	.000	1.500	1.000	.313	3.750	4.250	2.375	2.192	N/A	1.000	1.938	5.062	6.250
3-1/4"	1.000	3.750	1/2	.000	1.750	1.250	.375	4.250	4.750	2.625	2.758	N/A	1.375	2.438	6.000	7.500
4"	1.000	4.500	1/2	.000	1.750	1.250	.375	4.250	4.750	2.625	3.323	N/A	1.375	2.438	6.000	7.500
5"	1.000	5.500	1/2	.000	1.750	1.250	.500	4.500	5.000	2.875	4.101	N/A	1.375	2.438	6.375	7.750
6"	1.375	6.500	3/4	.625	2.000	1.500	.500	5.000	5.500	3.125	4.879	3.125	1.625	2.813	7.125	8.750

**Rod End Style #1**  
(Standard Male – KK Thread)

**Rod End Style #2**  
(Optional Male – CC Thread)

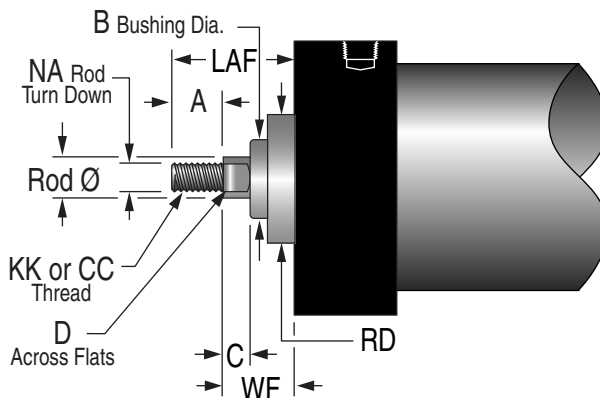

**Rod End Style #3**  
(Optional Female)

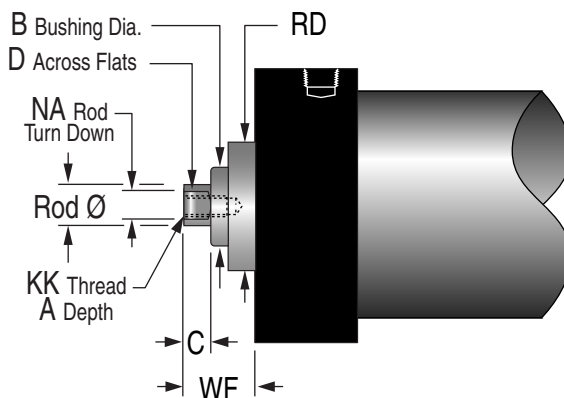

**Rod End Dimensions (inches)**

Bore	Rod	KK	CC	A	B	C	D	LAF	NA	RD	WF
1-1/2"	.625	7/16-20	1/2-20	.750	1.125	.375	.500	1.750	.585	N/A	1.000
2"	.625	7/16-20	1/2-20	.750	1.125	.375	.500	1.750	.585	N/A	1.000
2-1/2"	.625	7/16-20	1/2-20	.750	1.125	.375	.500	1.750	.585	N/A	1.000
3-1/4"	1.000	3/4-16	7/8-14	1.125	1.500	.500	.813	2.500	.960	N/A	1.375
4"	1.000	3/4-16	7/8-14	1.125	1.500	.500	.813	2.500	.960	N/A	1.375
5"	1.000	3/4-16	7/8-14	1.125	1.500	.500	.813	2.500	.960	N/A	1.375
6"	1.375	1-14	1 1/4-12	1.625	2.000	.625	1.125	3.250	1.313	3.125	1.625



# Flange, Clevis & Eye Mounts

## MF1 – Head Rectangular Flange Order Code F1

## MF2 – Cap Rectangular Flange Order Code F2

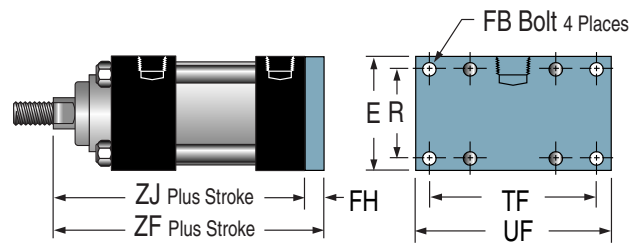
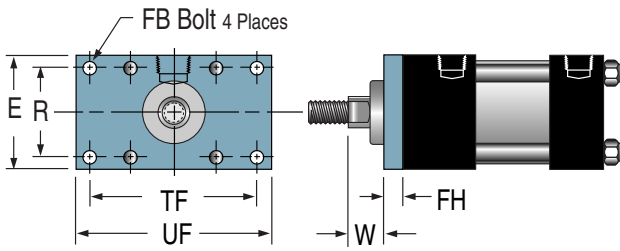

<b>Rectangular Flange Mount Dimensions (inches)</b>										
Bore	Rod	E	FB	FH	R	TF	UF	W	ZF	ZJ
1-1/2"	.625	2.000	1/4	.375	1.428	2.750	3.375	.625	5.000	4.625
2"	.625	2.500	5/16	.375	1.838	3.375	4.125	.625	5.000	4.625
2-1/2"	.625	3.000	5/16	.375	2.192	3.875	4.625	.625	5.125	4.750
3-1/4"	1.000	3.750	3/8	.625	2.758	4.688	5.500	.750	6.250	5.625
4"	1.000	4.500	3/8	.625	3.323	5.438	6.250	.750	6.250	5.625
5"	1.000	5.500	1/2	.625	4.101	6.625	7.625	.750	6.500	5.875
6"	1.375	6.500	1/2	.750	4.879	7.625	8.625	.875	7.375	6.625

## MP1 & MP3 Fixed Clevis and Eye Mounts Order Codes P1 & P3

Pivot pins and retaining rings included.

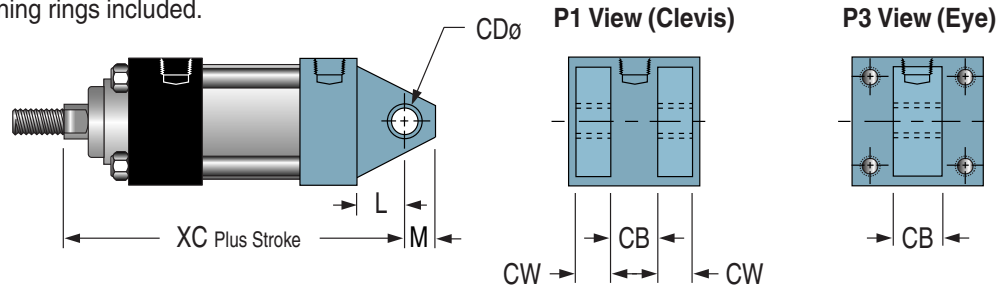

## MP2 & MP4 Detachable Clevis and Eye Mounts Order Codes P2 & P4

Pivot pins and retaining rings included.

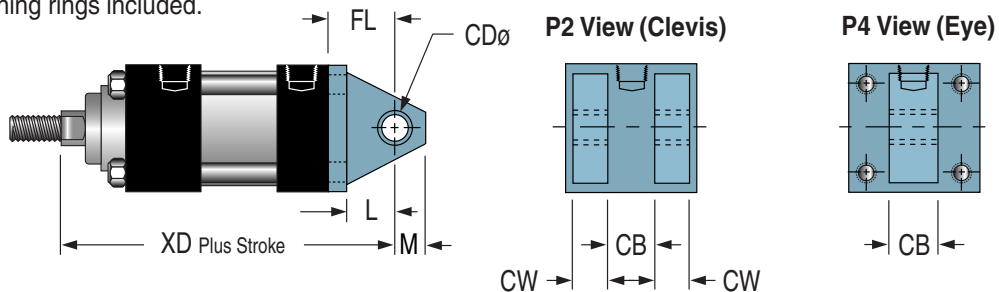

<b>Clevis &amp; Eye Mount Dimensions (inches)</b>									
Bore	Rod	CB	CD	CW	FL	L	M	XC	XD
1-1/2"	.625	.750	.500	.500	1.125	.750	.500	5.375	5.750
2"	.625	.750	.500	.500	1.125	.750	.500	5.375	5.750
2-1/2"	.625	.750	.500	.500	1.125	.750	.500	5.500	5.875
3-1/4"	1.000	1.250	.750	.625	1.875	1.250	.750	6.875	7.500
4"	1.000	1.250	.750	.625	1.875	1.250	.750	6.875	7.500
5"	1.000	1.250	.750	.625	1.875	1.250	.750	7.125	7.750
6"	1.375	1.500	1.000	.750	2.250	1.500	1.000	8.125	8.875

# Trunnion & Extended Tie Rod Mounts

Tel (352) 373-3578 ■ Fax (352) 375-8024 ■ E-Mail fabco@fabco-air.com ■ Web Site http://www.fabco-air.com

## MX1 – Extended Tie Rods Order Code X1

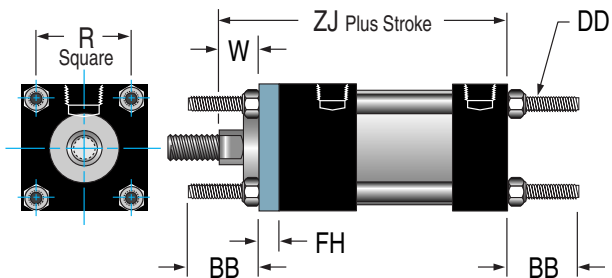

## MX2 – Cap Extended Tie Rods Order Code X2

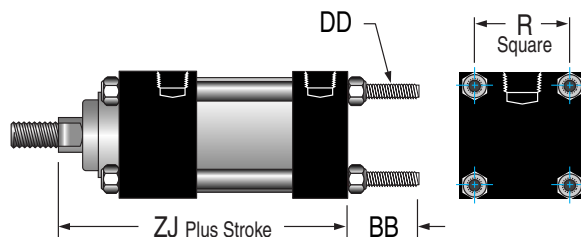

## MX3 – Head Extended Tie Rods Order Code X3

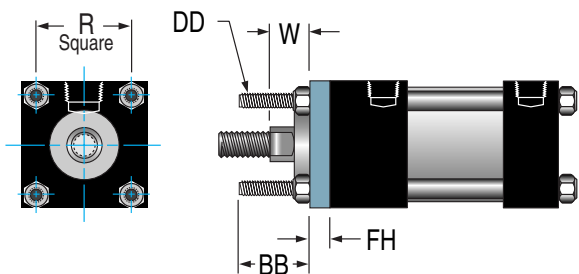

Bore	Rod	BB	DD	FH	R	W	ZJ
1-1/2"	.625	1.000	1/4-28	.375	1.428	.625	4.625
2"	.625	1.125	5/16-24	.375	1.838	.625	4.625
2-1/2"	.625	1.125	5/16-24	.375	2.192	.625	4.750
3-1/4"	1.000	1.375	3/8-24	.625	2.758	.750	5.625
4"	1.000	1.375	3/8-24	.625	3.323	.750	5.625
5"	1.000	1.813	1/2-20	.625	4.101	.750	5.875
6"	1.375	1.813	1/2-20	.750	4.879	.875	6.625

## MT1 – Head Trunnion Order Code T6

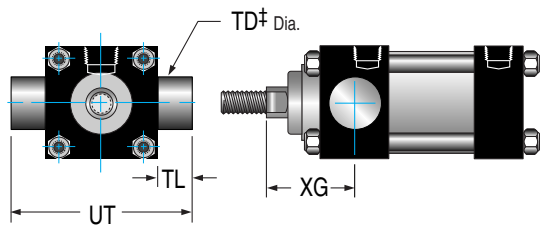

## MT4 – Mid Trunnion Order Code T8

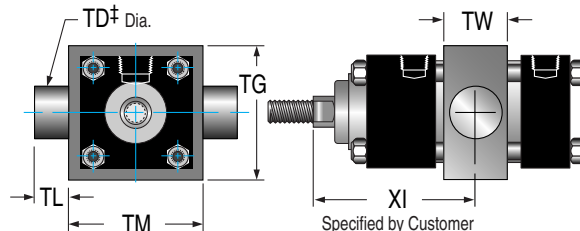

† Note: Trunnion pins are removable. User should apply thread locking adhesive on fastener at installation.

## MT2 – Cap Trunnion Order Code T7

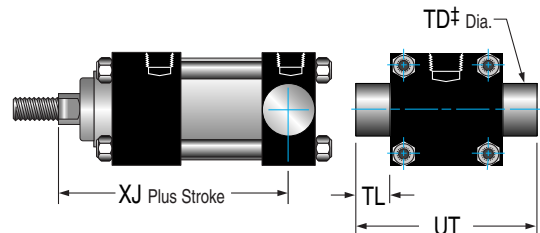

Bore	Rod	TD	TG	TL	TM	TW	UT	XG	XI (min)	XJ
1-1/2"	.625	1.000	2.500	1.000	2.500	1.250	4.000	1.750	3.125	4.125
2"	.625	1.000	3.000	1.000	3.000	1.500	4.500	1.750	3.250	4.125
2-1/2"	.625	1.000	3.500	1.000	3.500	1.500	5.000	1.750	3.250	4.250
3-1/4"	1.000	1.000	4.250	1.000	4.500	2.000	5.750	2.250	4.125	5.000
4"	1.000	1.000	5.000	1.000	5.250	2.000	6.500	2.250	4.125	5.000
5"	1.000	1.000	6.000	1.000	6.250	2.000	7.500	2.250	4.125	5.250
6"	1.375	1.375	7.000	1.375	7.625	2.500	9.250	2.625	4.875	5.875

## Sleeve Nut Mount Order Code SN

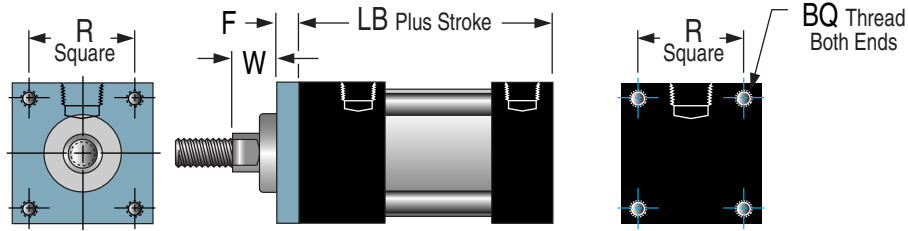

**SN - Sleeve Nut Mount Dimensions (inches)**

Bore	Rod	BQ	F	LB	R	W
1-1/2"	.625	1/4-28	.375	3.625	1.428	.625
2"	.625	5/16-24	.375	3.625	1.838	.625
2-1/2"	.625	5/16-24	.375	3.750	2.192	.625
3-1/4"	1.000	3/8-24	.625	4.250	2.758	.750
4"	1.000	3/8-24	.625	4.250	3.323	.750
5"	1.000	1/2-20	.625	4.500	4.101	.750
6"	1.375	1/2-20	.750	5.000	4.879	.875

## MS1 – Angle Mount Order Code S1

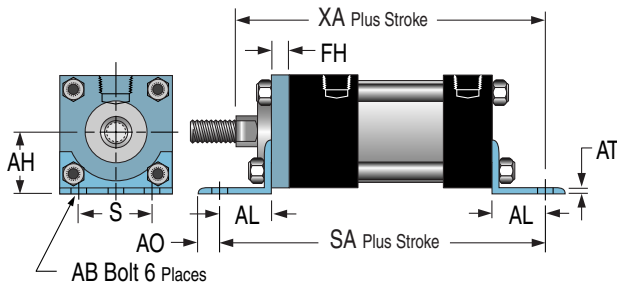

## MS2 – Side Lug Order Code S2

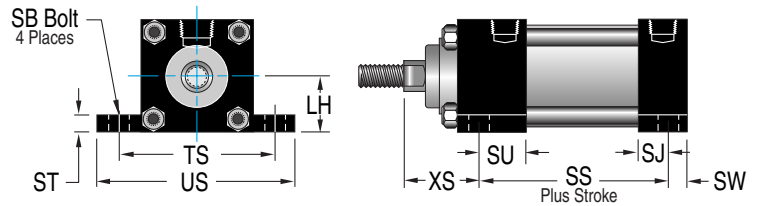

## MS4 – Bottom Tap Order Code S4

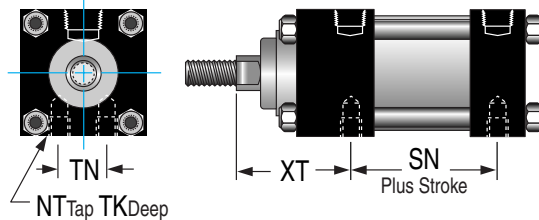

**Mounting Dimensions (inches)**

Bore	Rod	AB	AH	AL	AO	AT	FH	S	SA	XA	LH	SB	SJ	SS	ST	SU	SW	TS	US	XS	NT	SN	TK	TN	XT
1-1/2"	.625	3/8	1.188	1.000	.375	.125	.375	1.250	6.000	5.625	1.000	3/8	.625	2.875	.500	1.125	.375	2.750	3.500	1.375	1/4-20	2.250	.375	.625	1.938
2"	.625	3/8	1.438	1.000	.375	.125	.375	1.750	6.000	5.625	1.250	3/8	.625	2.875	.500	1.125	.375	3.250	4.000	1.375	5/16-18	2.250	.500	.875	1.938
2-1/2"	.625	3/8	1.625	1.000	.375	.125	.375	2.250	6.125	5.750	1.500	3/8	.625	3.000	.500	1.125	.375	3.750	4.500	1.375	3/8-16	2.375	.625	1.250	1.938
3-1/4"	1.000	1/2	1.938	1.250	.500	.125	.625	2.750	7.375	6.875	1.875	1/2	.750	3.250	.750	1.250	.500	4.750	5.750	1.875	1/2-13	2.625	.750	1.500	2.438
4"	1.000	1/2	2.250	1.250	.500	.125	.625	3.500	7.375	6.875	2.250	1/2	.750	3.250	.750	1.250	.500	5.500	6.500	1.875	1/2-13	2.625	.750	2.063	2.438
5"	1.000	5/8	2.750	1.375	.625	.188	.625	4.250	7.875	7.250	2.750	3/4	.563	3.125	1.000	1.063	.688	6.875	8.250	2.063	5/8-11	2.875	1.000	2.688	2.438
6"	1.375	3/4	3.250	1.375	.625	.188	.750	5.250	8.500	8.000	3.250	3/4	.813	3.625	1.000	1.313	.688	7.875	9.250	2.313	3/4-10	3.125	1.125	3.250	2.813



**What do you need? Tell us. We'll go to work for you!**

- Strokes in decimal increments or longer than 48"
- Stop Tubes for longer strokes
- Electroless Nickel Plating
- Extruded Aluminum Cylinder Tube (Enclosed Tie Rods)
- Hard Chrome Plated I.D. Steel Cyl. Tube
- Custom Rod End Features
- Additional Ports

## • Multi-Power® Cylinders (150 psi max)

Fabco-Air attaches multiple pistons to a common shaft and provides *internal* air passages through the shaft to all pistons. Internal baffles divide the cylinder body into separate sections or stages. When air pressure is applied to port #2 of the cylinder illustrated at the right, all three pistons are pressurized simultaneously nearly tripling the thrust. Cylinders can be built with up to four stages enabling thrusts of over 16,000 pounds to be reached!

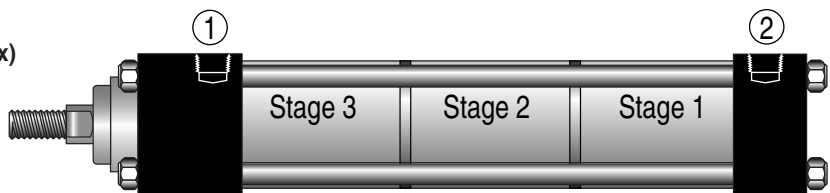

## • Tandem Cylinders

Tandem cylinders provide nearly twice the force on an equivalent double acting cylinder. Two pistons are attached to a common piston rod. Ports 2 and 4 are pressurized simultaneously to nearly double the extend force. Ports 1 and 3 are pressurized to double the retract force.

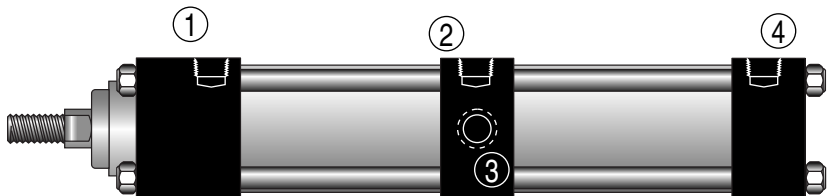

## • 3-Position Cylinders

3-Position cylinders are generally used when three distinct rod positions are required from a single cylinder body. Two cylinders are assembled tip-to-tail with a common center head. Using cylinders with two different strokes (the shorter located on the rear cylinder), enables the front rod to be extended from "home" to a positive mid-position or to full extension.

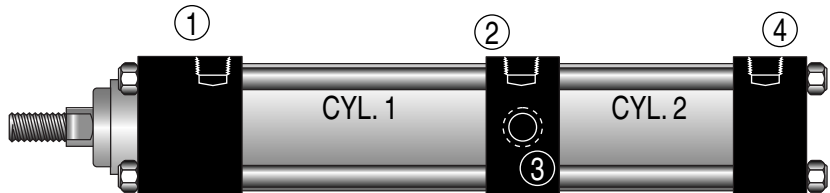

## • Back-to-Back Cylinders

Here two cylinders are mounted back-to-back. They can have the same or different strokes and can be operated independently. This assembly enables you to have four combinations of rods extended or retracted.

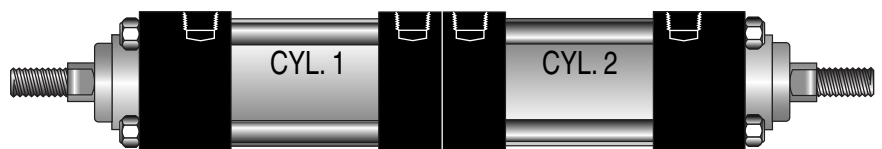

## Magnetic Piston: Option -E



- **Option -E** consists of a magnet bonded into the piston head. When the piston magnet moves past an external sensor, the magnetic field activates the sensor without physical contact.
- **Reliability** – The annular piston magnet is permanently bonded into a groove in the piston. It is a polarized permanent magnet of rubber bonded barium ferrite that is very stable and is not affected by shock. Under normal usage it will remain magnetized indefinitely.
- **Warning** – External magnetic fields and/or ferrous objects may

affect the strength of the piston magnet therefore affecting sensor actuation and piston position indication. Labels noting this are affixed to the cylinder.

- **Mounting** – The sensor is attached to a 2-part clamp that attaches rigidly to a tie rod and can be positioned anywhere along the length of the cylinder for very precise signaling.
- Two sensor styles are used – (a) the **9-2A197 Series** for 1-1/2" thru 4" bores requires a tie rod clamp, and (b) the **749 Series** which accommodates the larger diameter tie rods of the 5" and 6" bores with an integral clamp.

*Order Sensors, Sensor Clamps and Cables Separately. See page 12 for details.*

## Male Rod Thread Stud: Option -MR

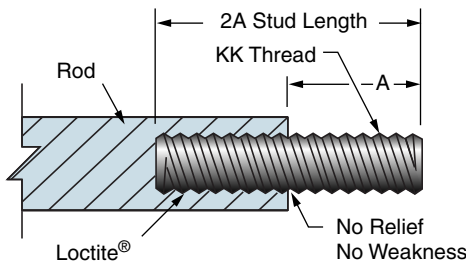

A high strength stud is threaded into the standard female rod end and retained with thread locking adhesive. This method eliminates the small diameter thread relief normally required when machining male threads. It provides a much stronger rod end which can be repaired, rather than replacing the complete rod, should the stud become damaged.

Part No.	KK	A	2A
NMR-7/16-20	7/16-20	.75	1.50
NMR-3/4-16	3/4-16	1.13	2.25
NMR-1-14	1-14	1.63	3.25

Also available separately for individual installation.

Available only with Style #3 Rod End.

## Rubber Bumpers Options: Head -BF<sup>‡</sup>, Cap -BR, Head & Cap -BB

A donut or pad of rubber is bonded in place to act as the piston stop and absorb the impact of the piston. This reduces noise and absorbs energy. Cylinder length will increase .062" per

bumper. Piston will travel a minimum of specified stroke.

- Operating Temperature: -20° to 220°F.
- ‡ Note: -BF not available 1-1/2" bore.

## Silent Seal Bumpers: Option -SB

Attached to the piston, these bumpers reduce the noise caused by the impact of the piston against the end cap. Standard pneumatic cushions may be used in conjunction with these cushions to further reduce end of stroke noise and impact while giving deceleration benefits.

- Available 1-1/2" thru 5" bores only.
- Operating Temperature: -20° to 200°F.
- Operating Pressure to 150 psi.

<b>Static Stroke Length Reduction (inches)</b>						
Bore	0 psi	20 psi	40 psi	60 psi	80 psi	100 psi
1-1/2"	.106	.056	.028	.018	0	0
2"	.090	.070	.046	.037	.018	0
2-1/2"	.201	.166	.122	.071	.008	0
3-1/4"	.160	.102	.082	.048	.038	0
4"	.150	.085	.065	.031	.005	0
5"	.219	.158	.099	.053	.015	0

## Accessories Guide to Part Numbers

Rod Thread	Rod Clevis	Eye Bracket	Pivot Pin	Rod Eye	Clevis Bracket
7/16-20	NRC-7/16-20	NEM-1-1/2	NPP-0.500	NRE-7/16-20	NPM-1-1/2
1/2-20	NRC-1/2-20	NEM-1-1/2	NPP-0.500	NRE-1/2-20	NPM-1-1/2
3/4-16	NRC-3/4-16	NEM-3-1/4	NPP-0.750	NRE-3/4-16	NPM-3-1/4
7/8-14	NRC-7/8-14	NEM-6	NPP-1.000	-	-
1-14	NRC-1-14	NEM-6	NPP-1.000	NRE-1-14	NPM-6
1 1/4-12	NRC-1-1/4-12	-	NPP-1.375	-	-

Bore	Mount	Eye Bracket	Pivot Pin	Mount	Clevis Bracket
1 1/2, 2, 2 1/2	MP1 & MP2 Clevis	NEM-1-1/2	NPP-0.500	MP3 & MP4 Eye	NPM-1-1/2
3 1/4, 4, 5	MP1 & MP2 Clevis	NEM-3-1/4	NPP-0.750	MP3 & MP4 Eye	NPM-3-1/4
6	MP1 & MP2 Clevis	NEM-6	NPP-1.000	MP3 & MP4 Eye	NPM-6

## Clevis Bracket – Pivot pin NOT included

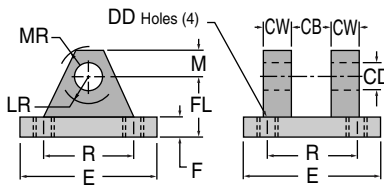

Part No.	CB	CD	CW	DD	E	F	FL	LR	M	MR	R
NPM-1-1/2	.750	.500	.500	3/8-24	2.500	.375	1.125	.500	.500	.563	1.625
NPM-3-1/4	1.250	.750	.625	1/2-20	3.500	.625	1.875	1.063	.750	1.063	2.563
NPM-6	1.500	1.000	.750	5/8-18	4.500	.750	2.250	1.250	1.000	1.125	3.250

## Eye Bracket

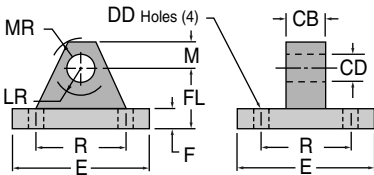

Part No.	CB	CD	DD	E	F	FL	LR	M	MR	R
NEM-1-1/2	.750	.500	.406	2.500	.375	1.125	.750	.500	.563	1.625
NEM-3-1/4	1.250	.750	.531	3.500	.625	1.875	1.250	.750	.875	2.563
NEM-6	1.500	1.000	.656	4.500	.750	2.250	1.500	1.000	1.250	3.250

## Rod Clevis – Pivot pin NOT included

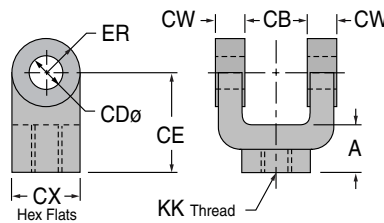

Part No.	KK	A	CB	CD	CE	CW	CX	ER
NRC-7/16-20	7/16-20	.750	.750	.500	1.500	.500	1.000	.500
NRC-1/2-20	1/2-20	.750	.750	.500	1.500	.500	1.000	.500
NRC-3/4-16	3/4-16	1.125	1.250	.750	2.375	.625	1.250	.750
NRC-7/8-14	7/8-14	1.625	1.500	1.000	3.125	.750	1.500	1.000
NRC-1-14	1-14	1.625	1.500	1.000	3.125	.750	1.500	1.000
NRC-1-1/4-12	1 1/4-12	2.000	2.000	1.375	4.125	1.000	2.000	1.375

## Rod Eye

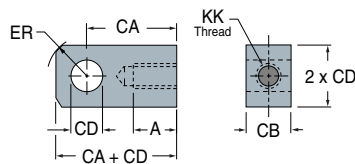

Part No.	KK	A	CA	CB	CD	ER
NRE-7/16-20	7/16-20	.750	1.500	.750	.500	.625
NRE-1/2-20	1/2-20	.750	1.500	.750	.500	.625
NRE-3/4-16	3/4-16	1.125	2.063	1.250	.750	.875
NRE-1-14	1-14	1.625	2.813	1.500	1.000	1.188
NRE-1-1/4-12	1 1/4-12	2.000	3.438	2.000	1.375	1.563

## Pivot Pin

(Includes retaining rings)

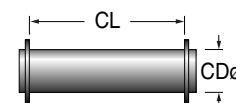

Part No.	CD	CL
NPP-0.500	.500	1.875
NPP-0.750	.750	2.625
NPP-1.000	1.000	3.125
NPP-1.375	1.375	4.125

## Alignment Couplers

Alignment couplers can be used in both push or pull applications. Linear couplers can prevent binding caused by misalignment and allow a greater tolerance between the cylinder centerline and the mating part.

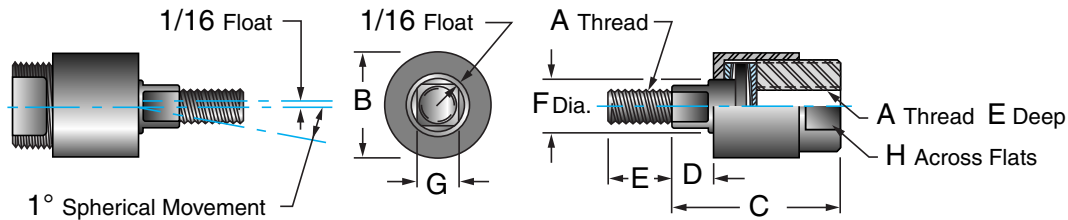

Part Number	A	B	C	D	E	F	G	H	Max. Pull Load lbs.
NCP-7/16-20	7/16-20	1-1/4	2	1/2	3/4	5/8	1/2	1	2,535
NCP-1/2-20	1/2-20	1-1/4	2	1/2	3/4	5/8	1/2	1	3,500
NCP-3/4-16	3/4-16	1-3/4	2-5/16	1/2	1-1/8	31/32	13/16	1-1/2	8,750
NCP-7/8-14	7/8-14	1-3/4	2-5/16	1/2	1-1/8	31/32	13/16	1-1/2	9,750
NCP-1-14	1-14	2-1/2	2-15/16	1/2	1-5/8	1-3/8	1-5/32	2-1/4	16,125
NCP-1-1/4-12	1 1/4-12	2-1/2	2-15/16	1/2	1-5/8	1-3/8	1-5/32	2-1/4	19,600

### Seal Kits – Standard Rods

Bore	Single Rod Part No.	Double Rod Part No.
1-1/2"	N-1-1/2-□-SK	N-1-1/2-□D-SK
2"	N-2-□-SK	N-2-□D-SK
2-1/2"	N-2-1/2-□-SK	N-2-1/2-□D-SK
3-1/4"	N-3-1/4-□-SK	N-3-1/4-□D-SK
4"	N-4-□-SK	N-4-□D-SK
5"	N-5-□-SK	N-5-□D-SK
6"	N-6-□-SK	N-6-□D-SK

Insert "H" or "C" at □ for cushion at head end or cap end, or "HC" for both ends. Leave blank if none.

For Viton® seal kits add suffix "V" to part numbers above. Consult factory for pricing specific Viton® kit part numbers.

### Rod Bushings

Rod Dia.	Part No.
5/8"	N-0.625-BK
1"	N-1.000-BK
1-3/8"	N-1.375-BK

## Temperature Range:

-20° to + 80°C (-4° to + 176°F)

## Warning!

Do not exceed sensor ratings. Permanent damage to sensor may occur. Power supply polarity **MUST** be observed for proper operation of sensors. See wiring diagrams included with each sensor.

## Sensors for 1-1/2" to 4" Bores

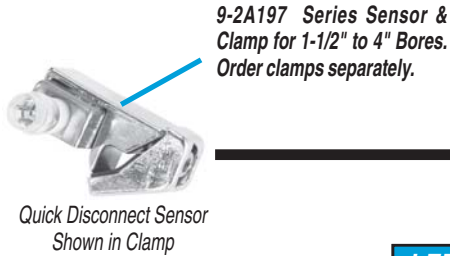

LED Lighted Magnetic Piston Position Sensors: Bores 1-1/2" – 4"			
Product	9 ft. Prewired P/N	Quick Discon. P/N	Electrical Characteristics
Reed Switch	9-2A197-1004	9-2A197-1304	5-120 VDC/VAC, 0.5 Amp Max., 10 Watt Max., SPST N.O., 3.5 Voltage Drop
Electronic	9-2A197-1033	9-2A197-1333	Sourcing, PNP, 6-24 VDC, 0.5Amp Max., 1.0 Voltage Drop
Electronic	9-2A197-1034	9-2A197-1334	Sinking, NPN, 6-24VDC, 0.5Amp Max., 1.0 Voltage Drop

**9-2A197 Series Sensor Mounting Clamps – Part Number 800-200-000**

## Sensors for 5" and 6" Bores

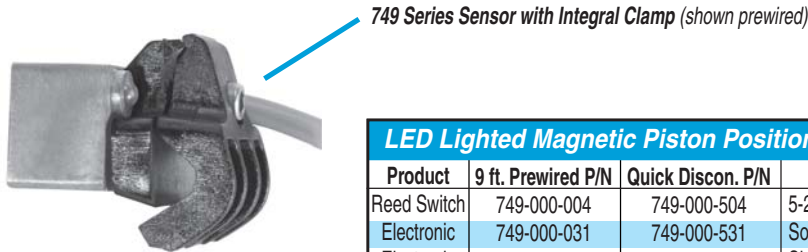

LED Lighted Magnetic Piston Position Sensors: Bores 5" – 6"			
Product	9 ft. Prewired P/N	Quick Discon. P/N	Electrical Characteristics
Reed Switch	749-000-004	749-000-504	5-240 VDC/VAC, 1 Amp Max., 30 Watt Max., SPST N.O., 3.0 Voltage Drop
Electronic	749-000-031	749-000-531	Sourcing, PNP, 6-24 VDC, 1.0 Amp Max., 0.5 Voltage Drop
Electronic	749-000-032	749-000-532	Sinking, NPN, 6-24 VDC, 1.0 Amp Max., 0.5 Voltage Drop

## Female Cordsets



Female Cordsets for 9-2A197 Series Quick Disconnect Sensors				Female Cordsets for 749 Series Quick Disconnect Sensors		
Length	1 Meter	2 Meter	5 Meter	Length	2 Meter	5 Meter
Part No.	CFC-1M	CFC-2M	CFC-5M	Part No.	CFC-2M-12	CFC-5M-12

### ***1 Year Limited Warranty for Catalog #NF-6 Products***

Subject to the following conditions, FABCO-AIR, Inc., warrants to its immediate purchaser (Purchaser) that at the time of shipment this product is free and clear of all liens and encumbrances, is free from defects in material and workmanship and will conform to samples if the order is based on samples, or to FABCO-AIR's applicable product specifications, or to Purchaser's written specifications to the extent they have been accepted in writing by FABCO-AIR. All products are subject to FABCO-AIR's normal manufacturing and commercial variations and practices. **THE FOREGOING WARRANTY IS IN LIEU OF AND EXCLUDES ALL OTHER WARRANTIES NOT EXPRESSLY SET FORTH HEREIN, WHETHER EXPRESSED OR IMPLIED BY OPERATION OF LAW OR OTHERWISE, INCLUDING BUT NOT LIMITED TO ANY IMPLIED WARRANTIES OF MERCHANTABILITY OR FITNESS FOR PURPOSE.** Purchaser's exclusive remedy, and FABCO-AIR's sole liability under this warranty is expressly limited to the correction, replacement or refund of purchase price, at FABCO-AIR's option, of products which are returned freight prepaid, accompanied by proof of purchase and written claim of defect, and upon which inspection by FABCO-AIR and in FABCO-AIR's sole judgement do not comply with this warranty.

All warranties made by FABCO-AIR or imposed on FABCO-AIR by law shall expire one (1) year from date of shipment by FABCO-AIR.

This warranty does not cover and no warranty is made with respect to: (A) failures not reported to FABCO-AIR within the period specified above; (B) failure or damage due to misapplication, misuse, abuse, improper storage or handling, abnormal conditions of temperature, water, dirt, corrosive substances, or other contaminants; (C) products which have been repaired with parts or materials not furnished or approved by FABCO-AIR or by anyone other than FABCO-AIR or its authorized representative or products which have been in any way tampered with or altered; and (D) products damaged in shipment or storage or otherwise without fault of FABCO-AIR.

### ***Limitations on Liability***

FABCO-AIR's total responsibility for any claims, damages, losses or liabilities related to the product covered hereunder shall not exceed the purchase price of such product. In no event shall FABCO-AIR be liable for any special, indirect, incidental or consequential damages of any character, including, but not limited to, loss of use of productive facilities or equipment, lost profits, property damage, transportation, installation or removal or lost production whether suffered by Purchaser or any third party. FABCO-AIR disclaims all liability for any and all costs, claims, demands, charges, expenses or other damages, either direct or indirect, incident to all property damage arising out of any cause of action based on strict liability. This warranty gives you specific legal rights and you may have other rights from state to state.





# Fabco-Air Product Catalog Library

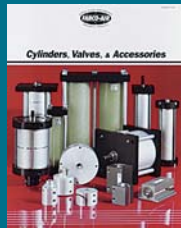

**Cylinders, Valves & Accessories Cat. CV9**  
 Describes Pancake<sup>®</sup>, Square 1<sup>®</sup>, Longstroke<sup>™</sup>, Multi-Power<sup>®</sup>, and HiPower<sup>™</sup>, cylinder lines. Also details valves, air-over-oil tanks, boosters and accessories.

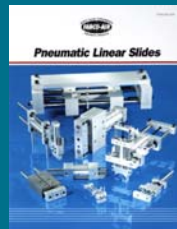

**Linear Slides Catalog LS-03**  
 Line includes 6 families of slides, pick & place units, and thin parts placers. 5/16" to 4" bores. Guide shafts 1/4" to 1-1/2".

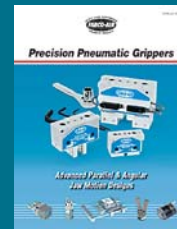

**Pneumatic Grippers Catalog GR-8**  
 • SPG & LPG parallel jaw motion with strokes from 1/4" to 24" & forces to 402 lbs. • GR & GS angular jaw styles with on-the-fly adjustment.



**New Linear Thrusters Bulletin GB-JA02**  
 Features longer strokes to 10" – and 4mm round profile sensors with surge suppression and polarity protection.

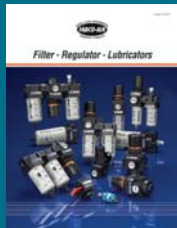

**Air Preparation - FRLs Catalog #FRL-06**  
 Broad line with port sizes from 1/8 NPT to 1 NPT includes new 3-way slide valves. Modular assembly. New 3-way lock out/tag out valves for safe equipment maintenance.



**Swing Clamps Bulletin #SC-DB04**  
 Clamp arm rotates 90° as it extends away from the workpiece. Features standard magnetic piston.

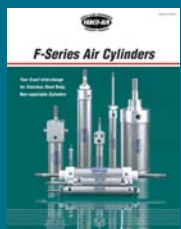

**Stainless Steel Body Air Cylinders Catalog SSB-03**  
 Exact interchange in bores from 5/16" to 3", strokes to 32". Popular options includes magnetic piston, non-rotating, and position feedback.

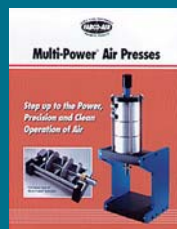

**Multi-Power<sup>®</sup> Air Presses Catalog FP16**  
 Details the powerful line of precision, force-multiplying air presses. Deliver forces to 11,000 pounds.



**Stopper Cylinders Bulletin #ST-DIX04**  
 Standard magnetic piston and a wide selection of styles. Roller direction is adjustable. Magnetic sensors can be mounted on body.

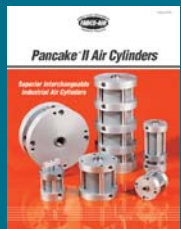

**Pancake<sup>®</sup> II Cylinders Catalog Pan2-2**  
 The direct industrial interchange. High strength composite cylinder barrel. 4 popular styles: Standard, Nonrotating, Multi-Power<sup>®</sup> and 3-position.



**Dual Funcion Slides Bulletin EDF-10**  
 Either of two slide styles (gantry or thruster) can be made from a single set of parts. Users can inventory less parts and assemble styles as needed.



**Specialty Valves and Control Valves Bulletin #14CAN**  
 • Composite body solenoid valves in 2 or 3-way, N/O or N/C, and manifoldable configurations. • Process Solenoid valves. • 5 Ported, 3 position, 1/4 NPT 4-way air valves.

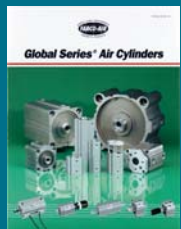

**Global Series<sup>™</sup> Air Cylinders Cat. GC-15**  
 Widest choice of models and options. Features non-lube service to 150 psi. Bores 12mm to 100mm  
 • Strokes 5mm - 150mm  
 • NPT or Metric ports