

Nickel-Plated Brass Pipe Fittings - BSP/METRIC

Connections M5 [10-32 UNF], 1/8, 1/4, 3/8, 1/2, 3/4 BSP

(Mod. #s ending in "0" are BSPT Male)

(Mod. #s ending in "1" are BSPP Male)

Sprint[®] available on several models.

When involved in factory maintenance or plant installation it is often difficult to be absolutely certain which size of fittings will be required. Pipe fittings provide a cost effective solution to this problem. The full range includes straight, L-shaped, T-shaped and cross piece male or female couplings and are available in a variety of thread sizes up to 3/4".

Material: brass OT58 UNI 5705 (nickel-plated).

The addition of the Camozzi **Sprint**[®] seal to twelve different models of pipe fittings eliminates the need to use liquid sealants or tape and save a considerable amount of time during installation. The **Sprint**[®] fitting can be connected and disconnected several times.

Material: brass OT58 UNI 5705 (nickel-plated).

T. min. - 40°C (-40°F)

T. max. +120°C (250°F)



TECHNICAL SPECIFICATIONS

Material	Brass OT58 UNI 5705, nickel plated
Threads	M5, 1/8, 1/4, 3/8, 1/2, 3/4 BSPT/BSPP
Operating pressure	From 0 - 580 psi
Fluid	Compressed air [for other types of fluid please contact our engineers]
Temperature Range	-40° - 120° C (-40° F - 250° F)

Fittings Mod. S2500... Hex Nipple

Sprint®

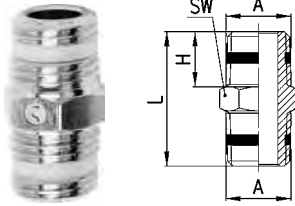

DIMENSIONS				
Mod.	A	H	L	SW
S2500 1/8	R1/8	7.5	19.5	12
S2500 1/4	R1/4	11	27	14
S2500 3/8	R3/8	11.5	28	17
S2500 1/2	R1/2	14	33.5	22

Fittings Mod. 2500... Hex Nipple

BSPT Male

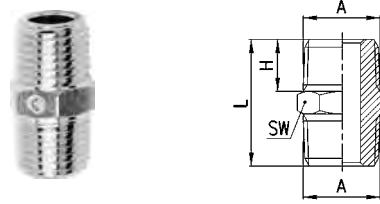

DIMENSIONS				
Mod.	A	H	L	SW
2500 1/8	R1/8	7.5	19.5	12
2500 1/4	R1/4	11	27	14
2500 3/8	R3/8	11.5	28	17
2500 1/2	R1/2	14	33.5	22
2500 3/4	R3/4	16.5	40	27

Fittings Mod. 2501... Hex Nipple

BSPP Male

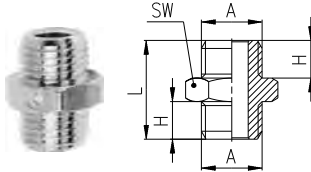

DIMENSIONS				
Mod.	A	H	L	SW
2501 M5	M5	4	11.5	8
2501 1/8	G1/8	6	16.5	13
2501 1/4	G1/4	8	21	17
2501 3/8	G3/8	9	23	19
2501 1/2	G1/2	10	25.5	24

Fittings Mod. S2510... Hex Nipple

Sprint®

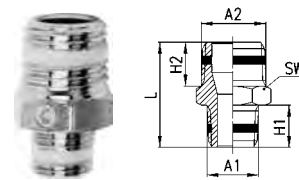

DIMENSIONS						
Mod.	A1	A2	H1	H2	L	SW
S2510 1/8-1/4	R1/8	R1/4	7.5	11	23.5	14
S2510 1/8-3/8	R1/8	R3/8	7.5	11.5	24	17
S2510 1/4-3/8	R1/4	R3/8	11	11.5	27.5	17
S2510 1/4-1/2	R1/4	R1/2	11	14	30.5	22
S2510 3/8-1/2	R3/8	R1/2	11.5	14	31	22

Fittings Mod. 2510... Hex Nipple

BSPT Male

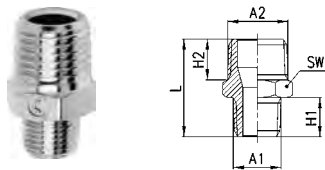

DIMENSIONS						
Mod.	A1	A2	H1	H2	L	SW
2510 1/8-1/4	R1/8	R1/4	7.5	11	23.5	14
2510 1/8-3/8	R1/8	R3/8	7.5	11.5	24	17
2510 1/4-3/8	R1/4	R3/8	11	11.5	27.5	17
2510 1/4-1/2	R1/4	R1/2	11	14	30.5	22
2510 3/8-1/2	R3/8	R1/2	11.5	14	31	22
2510 1/2-3/4	R1/2	R3/4	14	16.5	37.5	27

Fittings Mod. 2511... Hex Nipple

BSPP Male

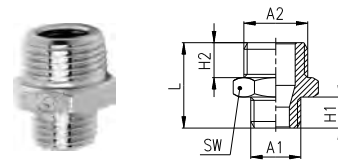

DIMENSIONS						
Mod.	A1	A2	H1	H2	L	SW
2511 M5-1/8	M5	1/8	4	6	14.5	13
2511 1/8-1/4	G1/8	1/4	6	8	19	17
2511 1/8-3/8	G1/8	3/8	6	9	20	19
2511 1/4-3/8	G1/4	3/8	8	9	22	19
2511 1/4-1/2	G1/4	1/2	8	10	23.5	24
2511 3/8-1/2	G3/8	1/2	9	10	24.5	24

Fittings Mod. S2520...

Sprint® Adapter

DIMENSIONS

Mod.	A	B	H	L	SW
S2520 1/8-1/8	R1/8	G1/8	7.5	17.5	13
S2520 1/8-1/4	R1/8	G1/4	7.5	19	17
S2520 1/8-3/8	R1/8	G3/8	7.5	20	20
S2520 1/4-1/4	R1/4	G1/4	11	22.5	17
S2520 1/4-3/8	R1/4	G3/8	11	23.5	20
S2520 1/4-1/2	R1/4	G1/2	11	27.5	24
S2520 3/8-3/8	R3/8	G3/8	11.5	24	20
S2520 3/8-1/2	R3/8	G1/2	11.5	28	24
S2520 1/2-1/2	R1/2	G1/2	14	30.5	24

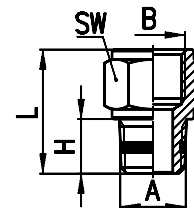

Fittings Mod. 2520...

BSPP Female - BSPT Male Adapter

DIMENSIONS

Mod.	A	B	H	L	SW
2520 1/8-1/8	R1/8	G1/8	7.5	17.5	13
2520 1/8-1/4	R1/8	G1/4	7.5	19	17
2520 1/8-3/8	R1/8	G3/8	7.5	20	20
2520 1/4-1/4	R1/4	G1/4	11	22.5	17
2520 1/4-3/8	R1/4	G3/8	11	23.5	20
2520 1/4-1/2	R1/4	G1/2	11	27.5	24
2520 3/8-3/8	R3/8	G3/8	11.5	24	20
2520 3/8-1/2	R3/8	G1/2	11.5	28	24
2520 1/2-1/2	R1/2	G1/2	14	30.5	24

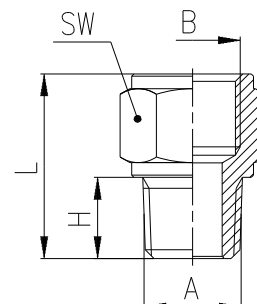

Fittings Mod. 2521...

BSPP Female — BSPP Male Adapter

DIMENSIONS

Mod.	A	B	H	L	SW
2521 M5-1/8	M5	1/8	4	14	13
2521 1/8-1/8	1/8	1/8	6	16	13
2521 1/8-1/4	1/8	1/4	6	17.5	17
2521 1/8-3/8	1/8	3/8	6	18.5	20
2521 1/4-1/4	1/4	1/4	8	19.5	17
2521 1/4-3/8	1/4	3/8	8	20.5	20
2521 1/4-1/2	1/4	1/2	8	24.5	24
2521 3/8-3/8	3/8	3/8	9	21.5	20
2521 3/8-1/2	3/8	1/2	9	25.5	24
2521 1/2-1/2	G1/2	G1/2	10	26.5	24

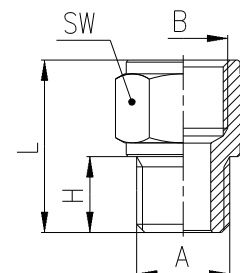

Fittings Mod. 2525...

BSPP Female - BSPP Male Extended Adapter

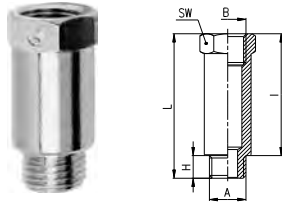

DIMENSIONS

Mod.	A	B	H	I	L	SW
2525 1/8-16	G1/8	G1/8	6	16	22	13
2525 1/8-36	G1/8	G1/8	6	36	42	13
2525 1/4-27	G1/4	G1/4	8	27	35	17
2525 1/4-43	G1/4	G1/4	8	43	51	17

Fittings Mod. S2530...

Sprint® Reducer

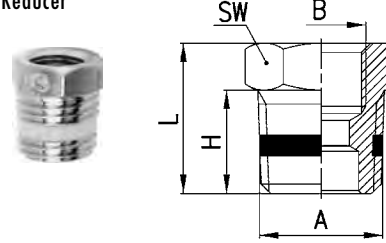

DIMENSIONS

Mod.	A	B	H	L	SW
S2530 1/4-1/8	R1/4	G1/8	11	16	14
S2530 3/8-1/8	R3/8	G1/8	11.5	16.5	17
S2530 1/2-1/8	R1/2	G1/8	14	19.5	22
S2530 3/8-1/4	R3/8	G1/4	11.5	16.5	17
S2530 1/2-1/4	R1/2	G1/4	14	19.5	22
S2530 1/2-3/8	R1/2	G3/8	14	19.5	22

Fittings Mod. 2530...

BSPP Female - BSPT Male Reducer

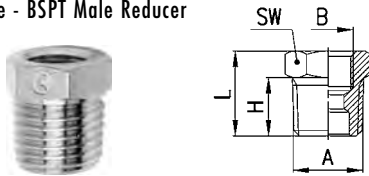

DIMENSIONS

Mod.	A	B	H	L	SW
2530 1/4-1/8	R1/4	G1/8	11	16	14
2530 3/8-1/8	R3/8	G1/8	11.5	16.5	17
2530 1/2-1/8	R1/2	G1/8	14	19.5	22
2530 3/8-1/4	R3/8	G1/4	11.5	16.5	17
2530 1/2-1/4	R1/2	G1/4	14	19.5	22
2530 1/2-3/8	R1/2	G3/8	14	19.5	22
2530 3/4-1/2	R3/4	G1/2	16.5	23.5	27

Fittings Mod. 2531...

BSPP Female — BSPP Male Reducer

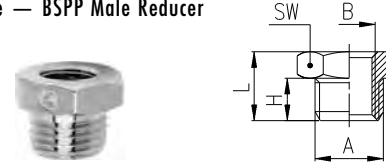

DIMENSIONS

Mod.	A	B	H	L	SW
2531 1/8-M5	G1/8	M5	6	10.5	13
2531 1/4-1/8	G1/4	G1/8	8	13	17
2531 3/8-1/8	G3/8	G1/8	9	14	19
2531 1/2-1/8	G1/2	G1/8	10	15.5	24
2531 3/8-1/4	G3/8	G1/4	9	14	19
2531 1/2-1/4	G1/2	G1/4	10	15.5	24
2531 1/2-3/8	G1/2	G3/8	10	15.5	24

Fittings Mod. 2541..

BSPP Female - **Sprint**® Male Swivel Adapter

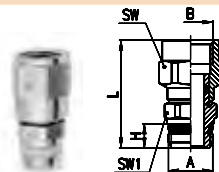

DIMENSIONS

Mod.	A	B	H	L	SW	SW1
2541 1/8-1/8	1/8	1/8	5.5	26.5	14	12
2541 1/4-1/4	1/4	1/4	7	32.5	17	14
2541 3/8-3/8	3/8	3/8	8	34.5	22	19

Fittings Mod. 2543...

BSPP Female Coupling

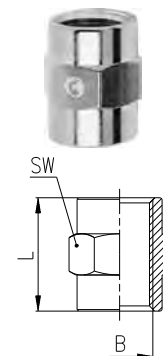

DIMENSIONS

Mod.	B	L	SW
2543 M5	M5	11	8
2543 1/8	G1/8	15	13
2543 1/4	G1/4	22	17
2543 3/8	G3/8	23	20
2543 1/2	G1/2	28	24

Fittings Mod. 2553...

BSPP Female Coupling (Reducing)

DIMENSIONS

Mod.	B1	B2	L	SW
2553 M5-1/8	M5	G1/8	13.5	13
2553 1/8-1/4	G1/8	G1/4	17	17
2553 1/8-3/8	G1/8	G3/8	18	20
2553 1/8-1/2	G1/8	G1/2	21.5	24
2553 1/4-3/8	G1/4	G3/8	19.5	20
2553 1/4-1/2	G1/4	G1/2	23	24
2553 3/8-1/2	G3/8	G1/2	24	24

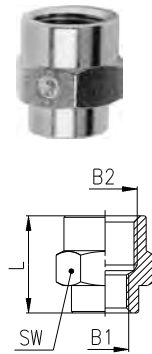

Fittings Mod. S2610...

Sprint® Plug Flush



DIMENSIONS

Mod.	L	SW	A
S2610 1/8	7.5	4	G1/8
S2610 1/4	9	6	G1/4
S2610 3/8	10	8	G3/8
S2610 1/2	11	10	G1/2

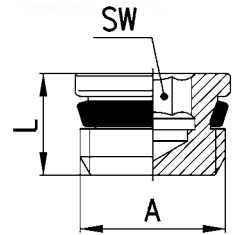

Fittings Mod. 2611...

BSPP Male Plug

DIMENSIONS

Mod.	A	H	L	SW
2611 M5	M5	4	7.5	8
2611 1/8	G1/8	6	10.5	13
2611 1/4	G1/4	8	13	17
2611 3/8	G3/8	9	14	19
2611 1/2	G1/2	10	15.5	24

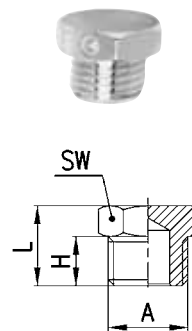

Fitting Mod. 2610

BSPT Plug

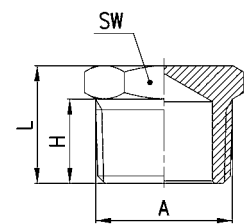

DIMENSIONS

Mod.	A	H	L	SW
2610 3/4	R3/4	16.5	23	27

Fittings Mod. S2615...

Sprint® Plug Flush

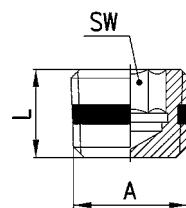

DIMENSIONS

Mod.	A	L	SW
S2615 1/8	R1/8	8	5
S2615 1/4	R1/4	10	7
S2615 3/8	R3/8	10	8

Fittings Mod. 2613...

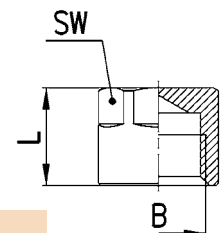

DIMENSIONS

Mod.	B	L	SW
2613 1/8	G1/8	11	12
2613 1/4	G1/4	3.5	15
2613 3/8	G3/8	15.5	18
2613 1/2	G1/2	22.5	19

Fittings Mod. S2010...

Sprint® Male Elbow

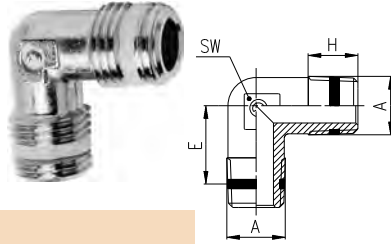

DIMENSIONS

Mod.	A	E	H	SW
S2010 1/8	R1/8	11.5	7.5	9
S2010 1/4	R1/4	13.5	11	12
S2010 3/8	R3/8	15.5	11.5	14
S2010 1/2	R1/2	16	14	16

Fittings Mod. 2010...

BSPT Male Elbow

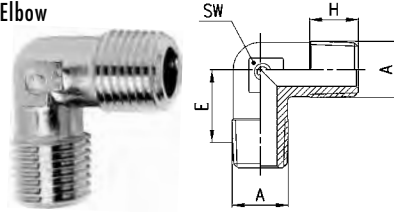

DIMENSIONS

Mod.	A	E	H	SW
2010 1/8	R1/8	11.5	7.5	9
2010 1/4	R1/4	13.5	11	12
2010 3/8	R3/8	15.5	11.5	14
2010 1/2	R1/2	16	14	16

Fittings Mod. 2601...

BSPP Male Stem Adapter Barbed

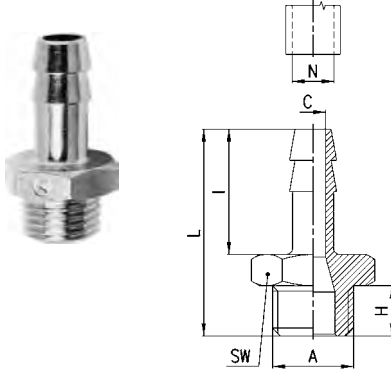

DIMENSIONS

Mod.	N	A	C	H	I	L	SW
2601 2-M5	2	M5	1.2	4	8	16	8
2601 4.5-M5	4	M5	2.5	4	15	23	8
2601 7-1/8	7	G1/8	4	6	20	30	12
2601 7-1/4	7	G1/4	4	8	20	33	17
2601 8-1/8	8	G1/8	5	6	20	30	12
2601 9-1/8	9	G1/8	5.5	6	20	30	12
2601 9-1/4	9	G1/4	6	8	20	33	17
2601 9-3/8	9	G3/8	6	9	20	34	19
2601 12-1/4	12	G1/4	8.5	8	20	33	17
2601 12-3/8	12	G3/8	9	9	20	34	19
2601 12-1/2	12	G1/2	9	10	20	35.5	24
2601 17-3/8	17	G3/8	12	9	24	38	19
2601 17-1/2	17	G1/2	13	10	24	39.5	24

Fittings Mod. 2013...

BSPP Female Elbow

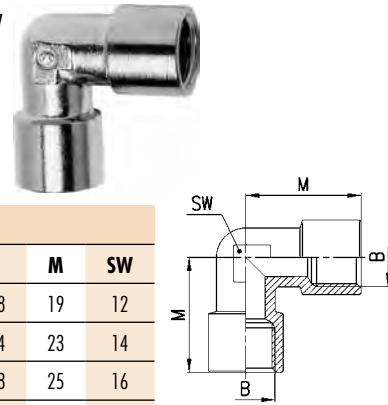

DIMENSIONS

Mod.	B	M	SW
2013 1/8	G1/8	19	12
2013 1/4	G1/4	23	14
2013 3/8	G3/8	25	16
2013 1/2	G1/2	31.5	20

All Female threads are BSPP. All male threads are BSPT.

Fittings Mod. S2020...

Sprint® Male-Female Elbow

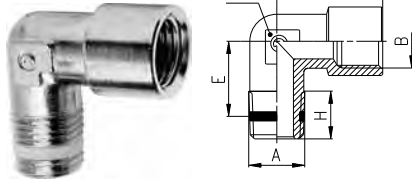

DIMENSIONS

Mod.	A	B	E	H	M	SW
S2020 1/8-1/8	R1/8	G1/8	11.5	8.5	19	12
S2020 1/4-1/4	R1/4	G1/4	15	11	23	14
S2020 3/8-3/8	R3/8	G3/8	15	11.5	25	16
S2020 1/2-1/2	R1/2	G1/2	17.5	14	31.5	20

Fittings Mod. 2021 and Mod. 2020...

Male-Female Elbow

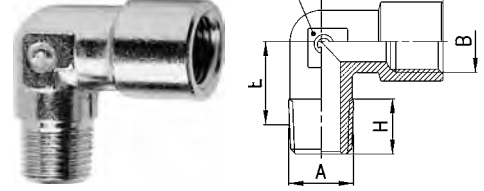

DIMENSIONS

Mod.	A	B	E	H	M	SW
2021-M5-M5	M5	M5	9	4	10.5	9
2020 1/8-1/8	R1/8	G1/8	11.5	8.5	19	12
2020 1/4-1/4	R1/4	G1/4	15	11	23	14
2020 3/8-3/8	R3/8	G3/8	15	11.5	25	16
2020 1/2-1/2	R1/2	G1/2	17.5	14	31.5	20

Fittings Mod. S2050...

Sprint® Male-Male-Female Tee

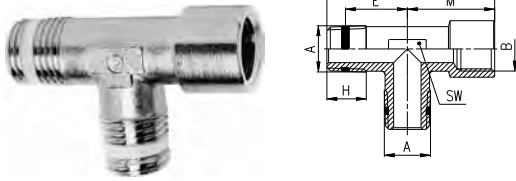

DIMENSIONS

Mod.	A	B	E	H	L	M	SW
S2050 1/8-1/8	R1/8	G1/8	11.5	8.5	37	19	12
S2050 1/4-1/4	R1/4	G1/4	15	11	46	23	14
S2050 3/8-3/8	R3/8	G3/8	15	11.5	48.5	25	16
S2050 1/2-1/2	R1/2	G1/2	17.5	14	60.5	31.5	20

Fittings Mod. 2050...

Male-Male-Female Tee

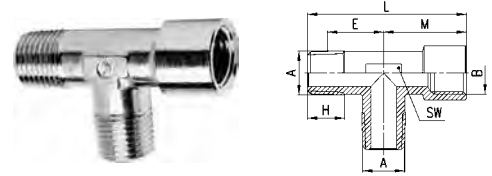

DIMENSIONS

Mod.	A	B	E	H	L	M	SW
2050 1/8-1/8	1/8	1/8	11.5	8.5	37	19	12
2050 1/4-1/4	1/4	1/4	15	11	46	23	14
2050 3/8-3/8	3/8	3/8	15	11.5	48.5	25	16
2050 1/2-1/2	1/2	1/2	17.5	14	60.5	31.5	20

Fittings Mod. S2060...

Sprint® Female-Male-Female Tee

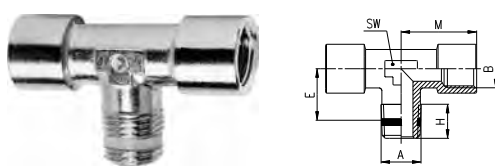

DIMENSIONS

Mod.	A	B	E	H	M	SW
S2060 1/8-1/8	R1/8	G1/8	11.5	8.5	19	12
S2060 1/4-1/4	R1/4	G1/4	15	11	23	14
S2060 3/8-3/8	R3/8	G3/8	15	11.5	25	16
S2060 1/2-1/2	R1/2	G1/2	17.5	14	31.5	20

Fittings Mod. 2060...

Female-Male-Female Tee

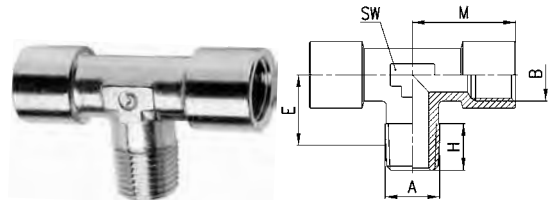

DIMENSIONS

Mod.	A	B	E	H	M	SW
2060 1/8-1/8	1/8	1/8	11.5	8.5	19	12
2060 1/4-1/4	1/4	1/4	15	11	23	14
2060 3/8-3/8	3/8	3/8	15	11.5	25	16
2060 1/2-1/2	1/2	1/2	17.5	14	31.5	20

All Female threads are BSPP. All male threads are BSPT.

Fittings Mod. S2070...

Sprint® Female-Female-Male Run Tee

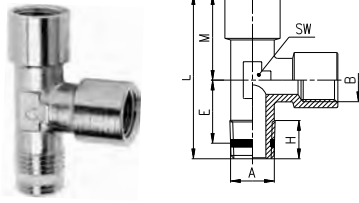

DIMENSIONS

Mod.	A	B	E	H	L	M	SW
S2070 1/8-1/8	R1/8	G1/8	11.5	8.5	37	19	12
S2070 1/4-1/4	R1/4	G1/4	15	11	46	23	14
S2070 3/8-3/8	R3/8	G3/8	15	11.5	48.5	25	16
S2070 1/2-1/2	R1/2	G1/2	17.5	14	60.5	31.5	20

Fittings Mod. 2070...

BSPP Female-Female-Male Run Tee

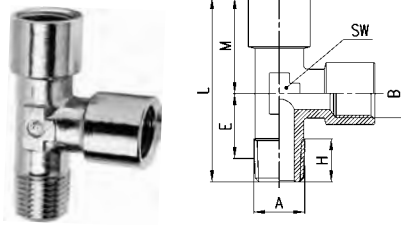

DIMENSIONS

Mod.	A	B	E	H	L	M	SW
2070 1/8-1/8	1/8	1/8	11.5	8.5	37	19	12
2070 1/4-1/4	1/4	1/4	15	11	46	23	14
2070 3/8-3/8	3/8	3/8	15	11.5	48.5	25	16
2070 1/2-1/2	1/2	1/2	17.5	14	60.5	31.5	20

Fittings Mod. S2080...

Sprint® Male-Male-Male Tee

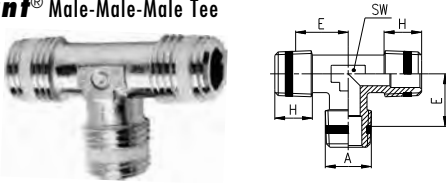

DIMENSIONS

Mod.	A	E	H	SW
S2080 1/8	R1/8	11.5	7.5	9
S2080 1/4	R1/4	13.5	11	12
S2080 3/8	R3/8	15.5	11.5	14
S2080 1/2	R1/2	16	14	16

Fittings Mod. 2080...

Male-Male-Male Tee

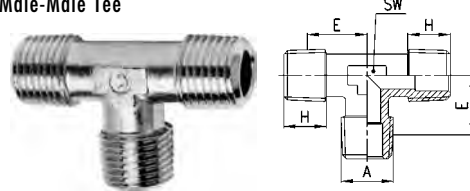

DIMENSIONS

Mod.	A	E	H	SW
2080 1/8	1/8	11.5	7.5	9
2080 1/4	1/4	13.5	11	12
2080 3/8	3/8	15.5	11.5	14
2080 1/2	1/2	16	14	16

Fittings Mod. S2090...

Sprint® Male-Female-Male Tee

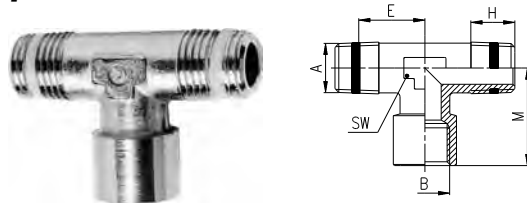

DIMENSIONS

Mod.	A	B	E	H	M	SW
S2090 1/8-1/8	R1/8	G1/8	11.5	8.5	19	12
S2090 1/4-1/4	R1/4	G1/4	15	11	23	14
S2090 3/8-3/8	R3/8	G3/8	15	11.5	25	16
S2090 1/2-1/2	R1/2	G1/2	17.5	14	31.5	20

Fittings Mod. 2090...

Male-Female-Male Tee

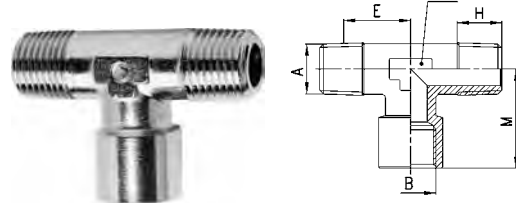

DIMENSIONS

Mod.	A	B	E	H	M	SW
2090 1/8-1/8	R 1/8	1/8	11.5	8.5	19	12
2090 1/4-1/4	R 1/4	1/4	15	11	23	14
2090 3/8-3/8	R 3/8	3/8	15	11.5	25	16
2090 1/2-1/2	R 1/2	1/2	17.5	14	31.5	20

All Female threads are BSPP. All male threads are BSPT.

Fittings Mod. 2003...

Female Tee

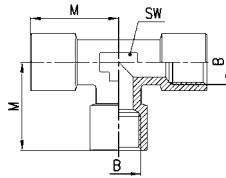

DIMENSIONS

Mod.	B	M	SW
2003 1/8	G1/8	19	12
2003 1/4	G1/4	23	14
2003 3/8	G3/8	25	16
2003 1/2	G1/2	31.5	20

Fittings Mod. S2040...

Sprint® Female-Female-Male "Y"

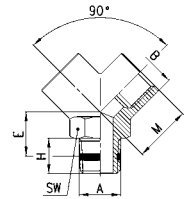

DIMENSIONS

Mod.	A	B	H	E	M	SW
S2040 1/8-1/8	R1/8	G1/8	8.9	13	17.5	14
S2040 1/4-1/4	R1/4	G1/4	11	13	18.5	17
S2040 3/8-3/8	R3/8	G3/8	13	18	22.5	22
S2040 1/2-1/2	R1/2	G1/2	15.3	22.5	27.5	26

Fittings Mod. 2040...

Female-Female-Male "Y"

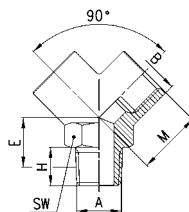

DIMENSIONS

Mod.	A	B	H	E	M	SW
2040 1/8-1/8	R1/8	G1/8	8.9	13	17.5	14
2040 1/4-1/4	R1/4	G1/4	11	13	18.5	17
2040 3/8-3/8	R3/8	G3/8	13	18	22.5	22
2040 1/2-1/2	R1/2	G1/2	15.3	22.5	27.5	26

Fittings Mod. 2043...

Female-Female-Female "Y"

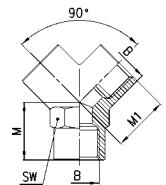

DIMENSIONS

Mod.	B	M	M1	SW
2043 1/8	G1/8	17.5	17.5	14
2043 1/4	G1/4	19	18.5	17
2043 3/8	G3/8	23.5	22.5	22
2043 1/2	G1/2	28	28	26

Fittings Mod. 2033...

Female Cross

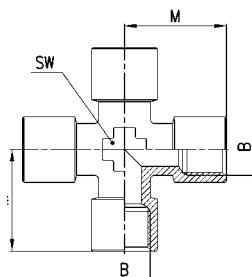

DIMENSIONS

Mod.	B	M	SW
2033 1/8	G1/8	19	12
2033 1/4	G1/4	23	14
2033 3/8	G3/8	25	16

Fittings Mod. 2023...

Banjo

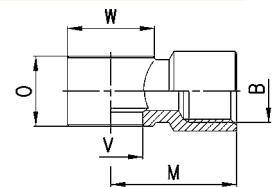

DIMENSIONS

Mod.	B	M	O	V	W
2023 M5-M5	M5	10.5	9	5.1	9
•2023 M5-M6	M6	10.5	9	5.1	9
2023 1/8-1/8	1/8	20	14.5	9.8	14
*2023 1/4-1/4	1/4	23.5	14.5	13.2	18
*2023 3/8-3/8	3/8	23.5	14.5	16.7	21

• Assembly possible only with Mod. SCU, SCO, SVU...M5
* Assembly required with Mod. 1635

Fittings Mod. 1631-01...

Stud Manifold
BSPP Male

DIMENSIONS					
Mod.	OD A	H	L	S	SW
1631 01-M5	M5	.157	.708	.177	.315
1631 01-1/8	1/8 BSP	.236	1.063	.335	.551
1631 01-1/4	1/4 BSP	.354	1.161	.335	.669
1631 01-3/8	3/8 BSP	.354	1.181	.335	.748

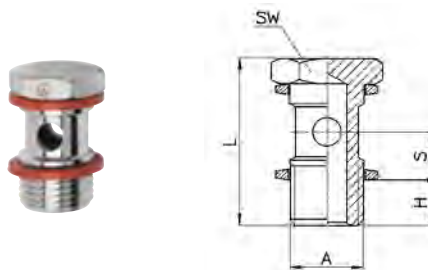

Fittings Mod. 1631-02...

Stud Manifold
BSPP Male

DIMENSIONS				
Mod.	OD A	H	L	SW
1631 02-1/8	1/8	.236	1.692	.551
1631 02-1/4	1/4	.315	1.791	.669
1631 02-3/8	3/8	.354	1.811	.748

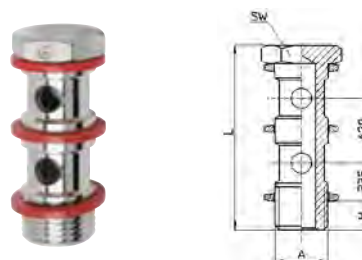

Fittings Mod. 1631-03...

Stud Manifold
BSPP Male

DIMENSIONS				
Mod.	OD A	H	L	SW
1631 03-1/8	1/8	.236	2.322	.551
1631 03-1/4	1/4	.315	2.421	.669
1631 03-3/8	3/8	.354	2.440	.748

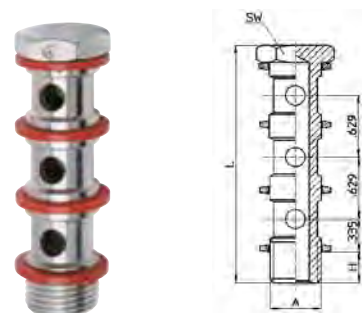

Fittings Mod. 3033...

BSPP Female Distribution Block

DIMENSIONS						
Mod.	B	C	F	L	T	SW
3033 1/8	1/8	4	4.5	25	17	16
3033 1/4	1/4	5	5.5	32	22	20
3033 3/8	3/8	7	5.5	40	26	25
3033 1/2	1/2	8	5.5	50	34	30

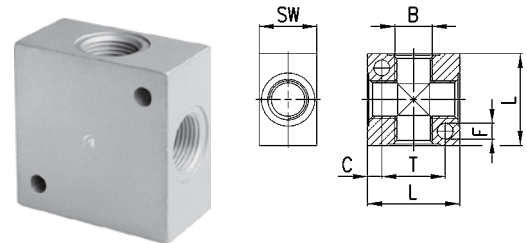

Fittings Mod. 3043...

BSPP Female Distribution Block Manifold

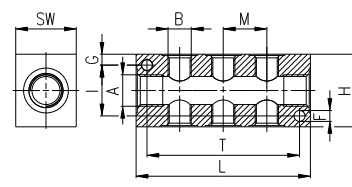

DIMENSIONS											
Mod.	INLET A	OUTLET B	B	F	G	H	I	L	M	T	SW
3043 1/4-3D-1/8	1/4	3	1/8	4.5	4.5	30	21	72	18	63	20
3043 1/4-4D-1/8	1/4	4	1/8	4.5	4.5	30	21	90	18	81	20
3043 1/4-5D-1/8	1/4	5	1/8	4.5	4.5	30	21	108	18	99	20
3043 1/4-6D-1/8	1/4	6	1/8	4.5	4.5	30	21	126	18	117	20
3043 3/8-3D-1/4	3/8	3	1/4	5.5	6	40	28	92	24	75	25
3043 3/8-4D-1/4	3/8	4	1/4	5.5	6	40	28	116	24	99	25
3043 3/8-5D-1/4	3/8	5	1/4	5.5	6	40	28	140	24	123	25
3043 3/8-6D-1/4	3/8	6	1/4	5.5	6	40	28	164	24	147	25
3043 1/2-3D-3/8	1/2	3	3/8	5.5	6.5	50	37	104	26	85	30
3043 1/2-4D-3/8	1/2	4	3/8	5.5	6.5	50	37	130	26	111	30
3043 1/2-5D-3/8	1/2	5	3/8	5.5	6.5	50	37	156	26	137	30
3043 1/2-6D-3/8	1/2	6	3/8	5.5	6.5	50	37	182	26	163	30

Fittings Mod. 3053...

BSPP Female Distribution Block Manifold

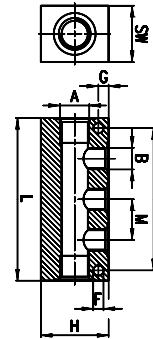

DIMENSIONS

Mod.	INLET A	OUTLET B	B	F	G	H	I	L	M	T	SW
3053 1/4-3L-1/8	1/4	3	1/8	4.5	4.5	30	21	72	18	63	20
3053 1/4-4L-1/8	1/4	4	1/8	4.5	4.5	30	21	90	18	81	20
3053 1/4-5L-1/8	1/4	5	1/8	4.5	4.5	30	21	108	18	99	20
3053 1/4-6L-1/8	1/4	6	1/8	4.5	4.5	30	21	126	18	117	20
3053 3/8-3L-1/4	3/8	3	1/4	5.5	6	40	28	92	24	75	25
3053 3/8-4L-1/4	3/8	4	1/4	5.5	6	40	28	116	24	99	25
3053 3/8-5L-1/4	3/8	5	1/4	5.5	6	40	28	140	24	123	25
3053 3/8-6L-1/4	3/8	6	1/4	5.5	6	40	28	164	24	147	25
3053 1/2-3L-3/8	1/2	3	3/8	5.5	6.5	50	37	104	26	85	30
3053 1/2-4L-3/8	1/2	4	3/8	5.5	6.5	50	37	130	26	111	30
3053 1/2-5L-3/8	1/2	5	3/8	5.5	6.5	50	37	156	26	137	30
3053 1/2-6L-3/8	1/2	6	3/8	5.5	6.5	50	37	182	26	163	30