

## Miniature Fog Lubricators



### SPECIFICATIONS

**WARNING!** Polycarbonate plastic bowls could rupture if exposed to incompatible chemicals whether inside or outside the bowl. If such chemicals are present, use a metal bowl.

#### Body

- Zinc, black coated

#### Polycarbonate Bowl

- Max. pressure 150 psi
- Operating temperature range 40°F to 125°F

#### Metal Bowl

- Black coated aluminum
- Max. pressure 200 psi
- Operating temperature range 40°F to 175°F

#### Recommended Oil

- SAE 10 oil or lighter
- Atomized average 2 micron
- .1 scfm to establish drip rate

### KITS

#### Bowl Kits

- Polycarbonate . . . . . BK1811
- Metal . . . . . BK1811M
- Repair kit . . . . . RK1812
- Dome Kit . . . . . AK35

**Mounting Kit** see page 65

- Mounting kit . . . . . FBK3

### FEATURES

- 1 oz. polycarbonate bowl
- Optional metal bowl
- Visible drip rate
- Easy to refill
- Fine adjustment screw
- Requires only .1 cfm of air flow to operate
- Automatically adjusts oil mist delivery with air flow variations

### OPTIONS

add suffix to part number in alpha order

- M Metal bowl . . . . . 1812M

### PERFORMANCE CHARACTERISTICS

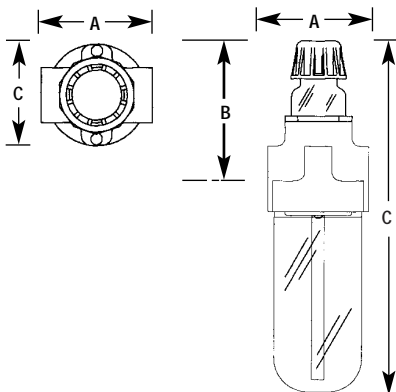
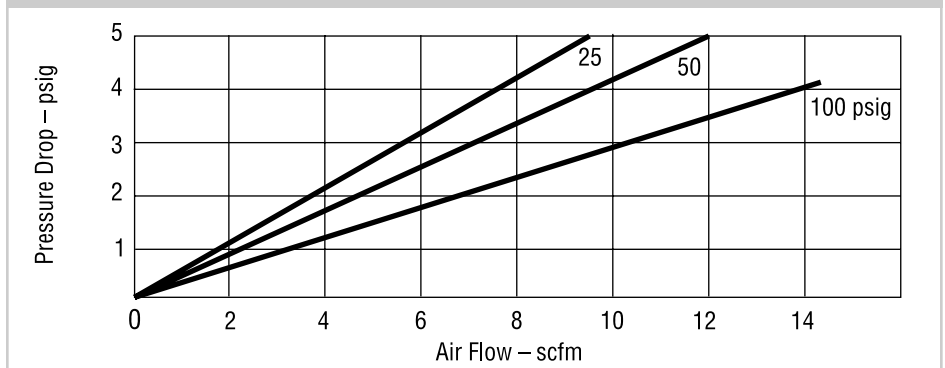

### DIMENSIONS

PIPE SIZE	MODEL NO.	MAX. FLOW SCFM*	BOWL CAPACITY	DIMENSIONS (INCHES)			WEIGHT (LBS.)
				A	B	C	
1/8"	L181	16	1 oz.	1 1/2	2	5	.4
1/4"	L182	16	1 oz.	1 3/8	2	5	.4

\* Flow scfm based on 5.0 psi Δ p @ 100 psig inlet.



# Tri-Star Series 3 Arrowfog Lubricators

# L3

### OPTIONS

add suffix to part number in alpha order

- M** 6 oz. black coated metal bowl . . . . . L354M
- W** 6 oz. black coated metal bowl with sight . . . . . L354W

### SPECIFICATIONS

**WARNING!** Polycarbonate plastic bowls could rupture if exposed to incompatible chemicals whether inside or outside the bowl. If such chemicals are present, use a metal bowl.

#### Body

- Black coated aluminum

#### Polycarbonate Bowl with Bowl Guard

- Max. pressure 150 psig
- Operating temperature range 40°F to 125°F

#### Metal Bowl

- Zinc, black coated
- Max. pressure 200 psig
- Operating temperature range 40°F to 175°F

#### Metal Bowl with Sight

- Zinc, black coated
- Max. pressure range 200 psig
- Operating temperature range 40°F to 175°F

#### Recommended Oil

- SAE 10 oil or lighter
- Atomized average 2 micron

### KITS

#### Bowl Kits

- Polycarbonate . . . . . BKL35
- Metal bowl without sight . . . . . BKL45M
- Metal bowl with sight . . . . . BKL45W

#### Repair Kits

- For L350 . . . . . RKL352
- Dome kit . . . . . AK35
- Fill plug kit . . . . . FK35

#### Mounting Kit see page 65

- Mounting kit . . . . . FBK5

#### Applications

- Air tools
- Air motors
- Single point lubrication

### FEATURES

- Aluminum housing
- Oil delivery at low air flow approximately 2 scfm
- Lubricator may be filled without shutting down air line
- 3-position non-rotating adjustment knob; push to lock, pull to adjust, detach for tamper resistant
- Can be converted on-line to Ultrafog lubricator with interchangeable module Part # RKL452

## PERFORMANCE CHARACTERISTICS

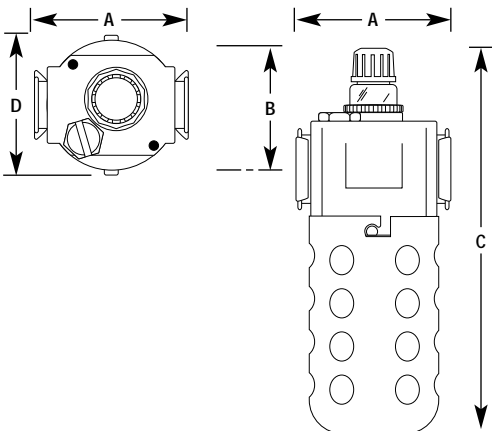
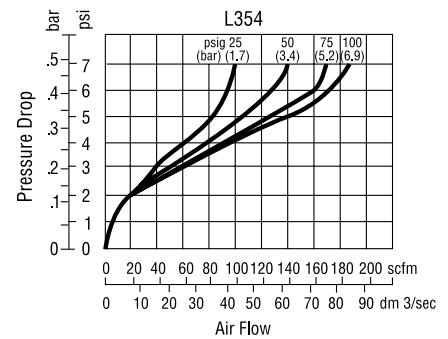
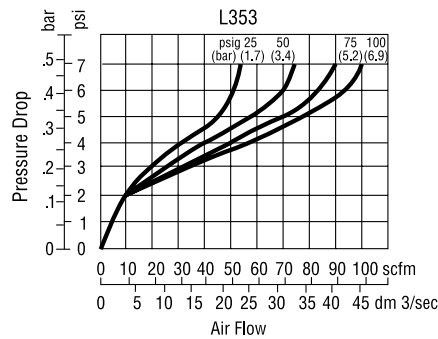
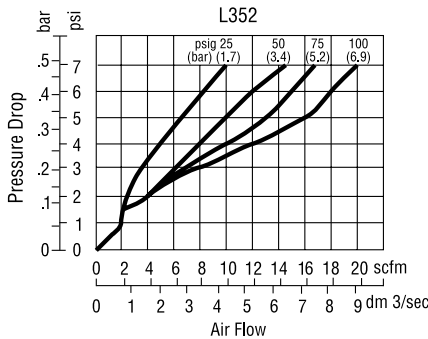

### DIMENSIONS

PIPE SIZE	MODEL NO.	MAX. FLOW SCFM*	BOWL CAPACITY	DIMENSIONS (INCHES)				WEIGHT (LBS.)
				A	B	C	D	
1/4"	L352	16	5 oz.	2 <sup>3</sup> / <sub>4</sub>	2 <sup>1</sup> / <sub>8</sub>	7"	2 <sup>1</sup> / <sub>2</sub>	1.0
3/8"	L353	82	5 oz.	2 <sup>3</sup> / <sub>4</sub>	2 <sup>1</sup> / <sub>8</sub>	7"	2 <sup>1</sup> / <sub>2</sub>	1.0
1/2"	L354	142	5 oz.	2 <sup>3</sup> / <sub>4</sub>	2 <sup>1</sup> / <sub>8</sub>	7"	2 <sup>1</sup> / <sub>2</sub>	1.0

\* Flow scfm based on 5.0 psi Δ p @ 100 psig inlet.



# MidFlow Series 3 Arrowfog Lubricators **L3**

## SPECIFICATIONS

### Body

- Black coated aluminum

### Metal Bowl

- Zinc, black coated
- Max. pressure 200 psig
- Operating temperature range 40°F to 175°F

### Metal Bowl with Sight

- Zinc, black coated
- Max. pressure range 200 psig
- Operating temperature range 40°F to 175°F

### Recommended Oil

- SAE 10 oil or lighter
- 3 scfm to establish drip rate
- Atomized average 2 micron droplet

## KITS

### Bowl Kits

- Metal bowl with sight . . . . . BKL47W
- Metal bowl without sight . . . . BKL47M
- Metal bowl with sight . . . . . BKL48W
- Metal bowl without sight . . . . BKL48M

### Repair Kits

- For L370 . . . . . RKL372
- For L380 . . . . . RKL382
- Dome kit . . . . . AK35
- Fill plug kit . . . . . FK37

### Mounting Kit see page 65

- Mounting kit . . . . . FBK7

## FEATURES

- Oil delivery at low air flow approximately 2 scfm
- Lubricator may be filled without shutting down air line
- 3-position non-rising adjustment knob; push to lock, pull to adjust, detach for tamper resistant
- Can be converted on-line to Ultrafog lubricator with interchangeable module Part # RKL452

## OPTIONS

add suffix to part number in alpha order  
**M** 6 oz. black coated metal bowl . . . . . L373M

## PERFORMANCE CHARACTERISTICS

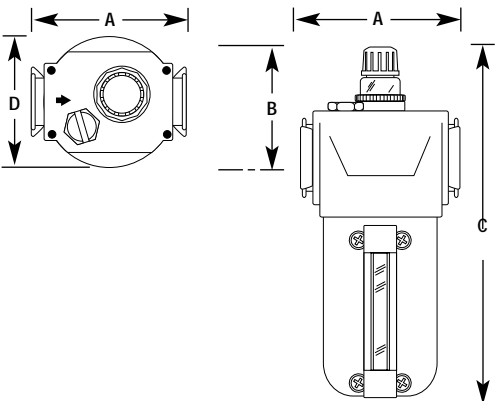
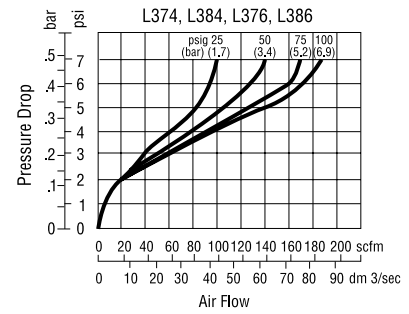
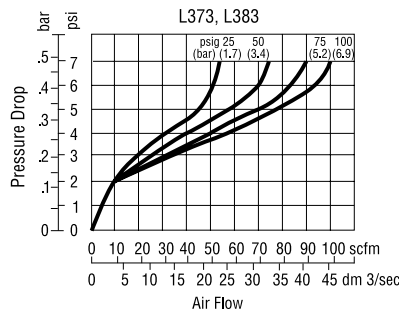

## DIMENSIONS

PIPE SIZE	MODEL NO.	MAX. FLOW SCFM*	BOWL CAPACITY	DIMENSIONS (INCHES)				WEIGHT (LBS.)
				A	B	C	D	
3/8"	L373W	82	10 oz.	3 <sup>3</sup> / <sub>4</sub>	2 <sup>5</sup> / <sub>16</sub>	8 <sup>13</sup> / <sub>32</sub>	3	2.4
3/8"	L383W	82	20 oz.	3 <sup>3</sup> / <sub>4</sub>	2 <sup>5</sup> / <sub>16</sub>	11 <sup>19</sup> / <sub>32</sub>	3	3.3
1/2"	L374W	142	10 oz.	3 <sup>3</sup> / <sub>4</sub>	2 <sup>5</sup> / <sub>16</sub>	8 <sup>13</sup> / <sub>32</sub>	3	2.4
1/2"	L384W	142	20 oz.	3 <sup>3</sup> / <sub>4</sub>	2 <sup>5</sup> / <sub>16</sub>	11 <sup>19</sup> / <sub>32</sub>	3	3.3
3/4"	L376W	142	10 oz.	3 <sup>3</sup> / <sub>4</sub>	2 <sup>5</sup> / <sub>16</sub>	8 <sup>13</sup> / <sub>32</sub>	3	2.4
3/4"	L386W	142	20 oz.	3 <sup>3</sup> / <sub>4</sub>	2 <sup>5</sup> / <sub>16</sub>	11 <sup>19</sup> / <sub>32</sub>	3	3.3

\* Flow scfm based on 5.0 psi Δ p @ 100 psig inlet.

# Tri•Star Series 4 Ultrafog Lubricators

# L4



## FEATURES

- 5 oz. polycarbonate bowl w/steel bowl guard
- Aluminum housing, black coated
- Oil delivery at low air flow approximately 2 scfm
- 3-position non-rising adjustment knob; push to lock, pull to adjust, detach for tamper resistant
- Convert on-line to Arrowfog with interchangeable module #RKL352
- In line modular installation

## OPTIONS

- add suffix to part number in alpha order
- M** 6 oz. black coated metal bowl . . . . . L454M
  - W** 6 oz. black coated metal bowl with sight . . . . . L454W

## SPECIFICATIONS

**WARNING!** Polycarbonate plastic bowls could rupture if exposed to incompatible chemicals whether inside or outside the bowl. If such chemicals are present, use a metal bowl.

### Body

- Black coated aluminum

### Polycarbonate Bowl with Bowl Guard

- Max. pressure 150 psig
- Operating temperature range 40°F to 125°F

### Metal Bowl

- Zinc, black coated
- Max. pressure 200 psig
- Operating temperature range 40°F to 175°F

### Metal Bowl with Sight

- Zinc, black coated
- Max. pressure range 200 psig
- Operating temperature range 40°F to 175°F

### Recommended Oil

- SAE 10 oil or lighter
- 2 scfm to establish drip rate
- Atomized average .6 micron
- 1 out of 28 drops travel downstream
- Cannot be filled under pressure

## KITS

### Bowl Kits

- Metal . . . . . BKL45M
- Metal with sight . . . . . BKL45W

### Repair Kits

- Adjustment dome kit . . . . . AK35
- Fill plug . . . . . FK35
- For Ultrafog . . . . . RKL452
- Sight kit . . . . . WK45

### Mounting Kit see page 65

- Mounting kit . . . . . FBK5

## Applications

- Multiple lubrication points

## PERFORMANCE CHARACTERISTICS

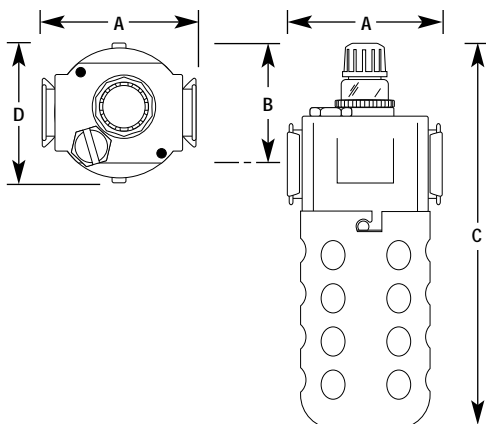
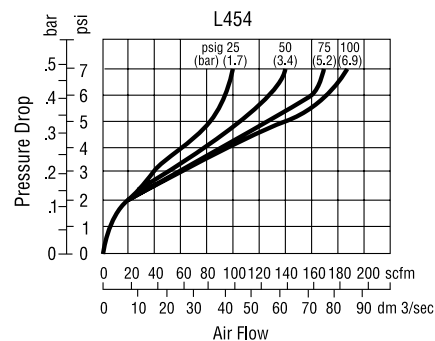
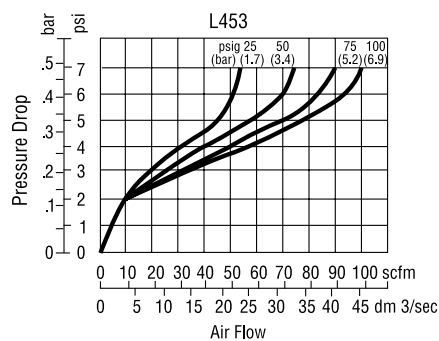
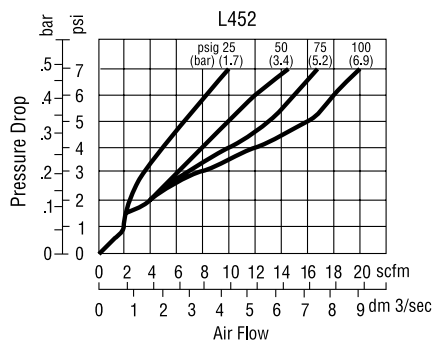

## DIMENSIONS

PIPE SIZE	MODEL NO.	MAX. FLOW SCFM*	BOWL CAPACITY	DIMENSIONS (INCHES)				WEIGHT (LBS.)
				A	B	C	D	
1/4"	L452	16	5 oz.	2 <sup>3</sup> / <sub>4</sub>	2 <sup>1</sup> / <sub>8</sub>	7"	2 <sup>1</sup> / <sub>2</sub>	1.0
3/8"	L453	82	5 oz.	2 <sup>3</sup> / <sub>4</sub>	2 <sup>1</sup> / <sub>8</sub>	7"	2 <sup>1</sup> / <sub>2</sub>	1.0
1/2"	L454	142	5 oz.	2 <sup>3</sup> / <sub>4</sub>	2 <sup>1</sup> / <sub>8</sub>	7"	2 <sup>1</sup> / <sub>2</sub>	1.0

\* Flow scfm based on 5.0 psi Δ p @ 100 psig inlet.



# MidFlow Series 4 Ultrafog Lubricators

# L4

### SPECIFICATIONS

#### Body

- Black coated aluminum

#### Metal Bowl

- Zinc, black coated
- Max. pressure 250 psig
- Operating temperature range 40°F to 125°F

#### Metal Bowl with Sight

- Zinc, black coated
- Max. pressure range 200 psig
- Operating temperature range 40°F to 175°F

#### Recommended Oil

- SAE 10 oil or lighter
- 2 scfm to establish drip rate
- Atomized average .6 micron
- 1 out of 28 drops travel downstream
- Cannot be filled under pressure

### KITS

#### Bowl Kits

- Metal bowl without sight . . . . BKL47M
- Metal bowl with sight . . . . . BKL47W

#### Repair Kits

- For L350 . . . . . RKL470
- Dome kit . . . . . AK37
- Fill plug kit . . . . . FK47

#### Mounting Kit see page 65

- Mounting kit . . . . . FBK7

### FEATURES

- Aluminum housing
- Oil delivery at low air flow approximately 2 scfm
- 3-position non-rising adjustment knob; push to lock, pull to adjust, detach for tamper resistant
- Convert on-line to Arrowfog with interchangeable module #RKL352

### OPTIONS

add suffix to part number in alpha order

- M 6 oz. black coated metal bowl . . . . . L472M

### PERFORMANCE CHARACTERISTICS

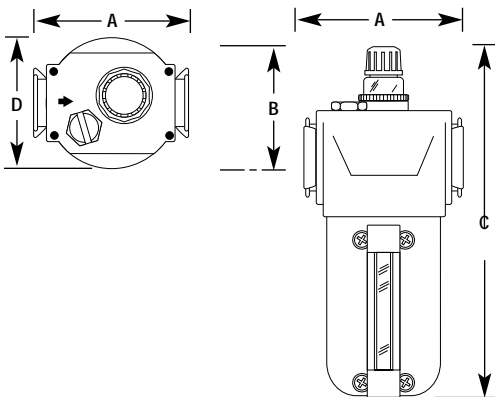
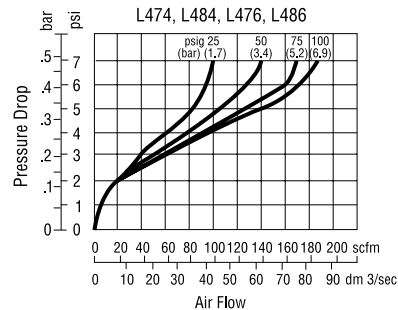
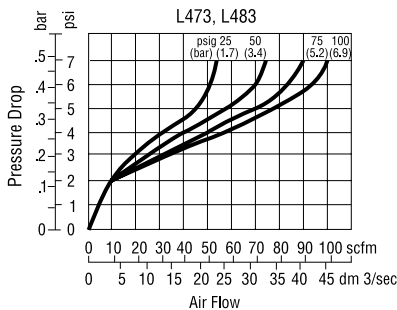

### DIMENSIONS

PIPE SIZE	MODEL NO.	MAX. FLOW SCFM*	BOWL CAPACITY	DIMENSIONS (INCHES)				WEIGHT (LBS.)
				A	B	C	D	
3/8"	L473W	82	10 oz.	3 3/4	2 5/16	8 13/32	3	2.4
3/8"	L483W	82	20 oz.	3 3/4	2 5/16	11 19/32	3	3.3
1/2"	L474W	142	10 oz.	3 3/4	2 5/16	8 13/32	3	2.4
1/2"	L484W	142	20 oz.	3 3/4	2 5/16	11 19/32	3	3.3
3/4"	L476W	142	10 oz.	3 3/4	2 5/16	8 13/32	3	2.4
3/4"	L486W	142	20 oz.	3 3/4	2 5/16	11 19/32	3	3.3

\* Flow scfm based on 5.0 psi Δ p @ 100 psig inlet.



# Arrowick Lubricators

## SPECIFICATIONS

### Body

- Black coated aluminum

### Metal Bowl

- Steel, black coated
- Max. pressure 250 psig
- Operating temperature range 40°F to 200°F

### Recommended Oil

- SAE 10 oil or lighter
- 30 scfm to establish drip rate

### Droplet Size

- 3 micron or less

## KITS

### Bowl Kits

- 29 oz. metal . . . . . BK4106M
- 29 oz. metal with sight . . . . . BK4106W
- 2 qt. metal with sight . . . . . BK4106LCM

### Repair Kits

- For 4106, 4106LCM, 4108, and 4108LCM . . . . . RK4106
- For 4112 and 4112LCM . . . . . RK4112
- Sight kit . . . . . WK35

### Applications

- Single point
- Flow can be reversed

## FEATURES

- Simple, trouble free design. It cannot be over-filled, and has greater bowl capacity which extends interval between filling
- Can be used downstream of 4 way valves because it accommodates reverse flow
- Bowl fills all the way to the top
- It can be filled under pressure no need to shut down air
- Tamper-proof internal adjustment
- Porous bronze oil metering diffuser introduces smallest possible oil particles to the air
- No small orifices to clog and stop oil delivery
- Automatically maintains air-oil ratio regardless of variations in air flow

## OPTIONS

add suffix to part number in alpha order  
**W** metal bowl w/sight glass . . . 4108W

Minimum Air Flow for Lubrication	
Model No.	Air Flow SCFM
4106	30 SCFM
4106LCM	30 SCFM
4108	30 SCFM
4108LCM	30 SCFM
4112	50 SCFM
4112LCM	50 SCFM

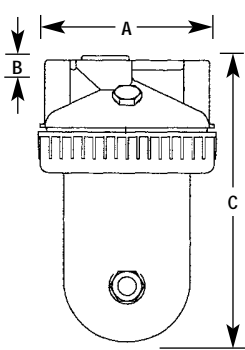
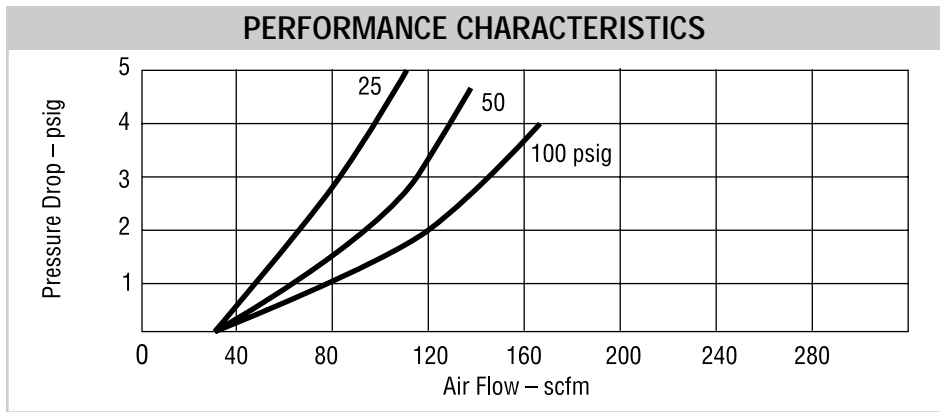

DIMENSIONS							
PIPE SIZE	MODEL NO.	MAX. FLOW SCFM*	BOWL CAPACITY	DIMENSIONS (INCHES)			WEIGHT (LBS.)
				A	B	C	
3/4"	4106	175	29 oz.	4 7/8	1 1/8	8 7/8	3.5
1"	4108	175	29 oz.	4 7/8	1 1/8	8 7/8	3.5
1 1/2"	4112	175	29 oz.	5 1/4	1 1/4	9	3.5
3/4"	4106LCM	175	60 oz.	4 7/8	1 1/8	13 1/2	6.0
1"	4108LCM	175	60 oz.	4 7/8	1 1/8	13 1/2	6.0
1 1/2"	4112LCM	175	60 oz..	5 1/4	1 1/4	13 1/2	6.0

\* Flow scfm based on 5.0 psi Δ p @ 100 psig inlet.