

R-Series Pushbuttons, Selector Switches



Pushbuttons

22 mm, NEMA 4, IP65



IEC 947-1

LED Pilot Light's Modular 22mm + 30mm



-13°, + 158°F Ambient Temp

Pushbuttons and Selectors
1 million mechanical Oper.
Emergency Stop
300,000 Operations

1th10 Amp, 600Volt
A600, Q600

FEATURES

- High Gloss Chrome
- Rugged Design
- Very Bright LED's (22 & 30mm)
- Modular Design
- Secure Screw Mounting
- Self Cleaning Contacts
- Stackable Contacts
- Positive Open Contacts →

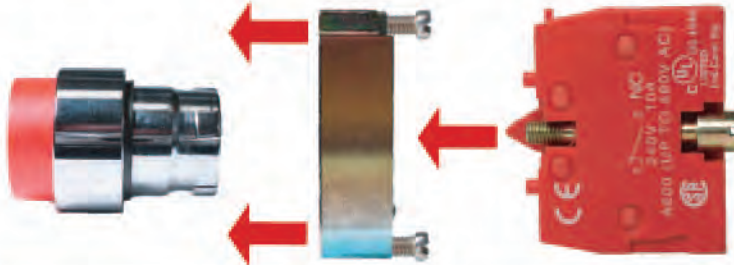

Metal
Chrome
Bezel

Steel Block Holder
Included with operators

Bolt - On
Contact
Block

A Secure + Safe System Versus Snap on Contacts

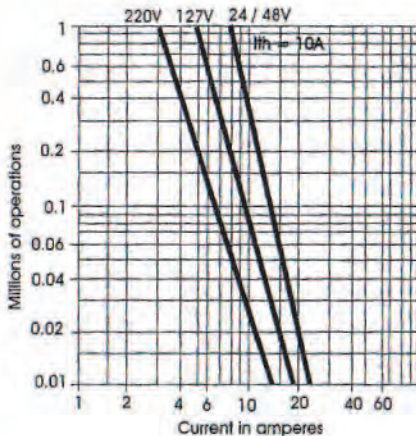

AC Ratings, Inductive - NEMA A600
35% Power Factor

Volts	Make Amperes	VA	Break Amperes	VA	Continuous carrying Amperes	Resistive 75% Power factor Make, Break & continuous Amperes
120	60	7200	6	720	10	10
240	30	7200	3	720	10	10
480	15	7200	1.5	720	10	10
600	12	7200	1.2	720	10	10

DC Ratings, UL Type Q600
Inductive and resistive Amps

Volts	Amps Make & Break	Amps Continuous
125	0.55	2.5
250	0.27	2.5
600	0.10	2.5

Minimum AC/DC 17 Volts, 25mA

Pushbutton Dimensions

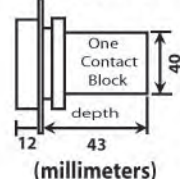

Illuminated Pushbuttons

Example:
R-GL-10-A
Green illuminated PB with 1N.O. contact & 110V bulb.

Illuminated Flush Pushbutton



Operator Only	
Green	R-GL
Red	R-RL
Yellow	R-YL
Blue	R-BLL
List \$	\$4.50

		Single Contact		Double Contacts				
								
Part #	1 Open Contact -* 10	1 Closed Contact -* 01	2 Open Contacts -* 20	2 Closed Contacts -* 02	1 Closed, 1 Open Contacts -* 11	LED Bulb Voltage		
	List	List	List	List	List	- ^	Voltage	
R-GL-*^A	\$20.50	\$20.50	\$25.50	\$25.50	\$25.50	M	12 V AC/DC	
R-RL-*^A	\$20.50	\$20.50	\$25.50	\$25.50	\$25.50	G	24 V AC/DC	
R-YL-*^A	\$20.50	\$20.50	\$25.50	\$25.50	\$25.50	O	48 V AC/DC	
R-BLL-*^A	\$33.50	\$33.50	\$38.50	\$38.50	\$38.50	A	110 V AC/DC	

Example:
R-RLE-01-A
Red illuminated PB with 1N.C. contact & 110V bulb.

Illuminated Extended Pushbutton



Operator Only	
Green	R-GLE
Red	R-RLE
Yellow	R-YLE
Blue	R-BLLE
List \$	\$4.50

		Single Contact		Double Contacts				
								
Part #	1 Open Contact -* 10	1 Closed Contact -* 01	2 Open Contacts -* 20	2 Closed Contacts -* 02	1 Closed, 1 Open Contacts -* 11	LED Bulb Voltage		
	List	List	List	List	List	- ^	Voltage	
R-GLE-*^A	\$20.50	\$20.50	\$25.50	\$25.50	\$25.50	M	12 V AC/DC	
R-RLE-*^A	\$20.50	\$20.50	\$25.50	\$25.50	\$25.50	G	24 V AC/DC	
R-YLE-*^A	\$20.50	\$20.50	\$25.50	\$25.50	\$25.50	O	48 V AC/DC	
R-BLLE-*^A	\$33.50	\$33.50	\$38.50	\$38.50	\$38.50	A	110 V AC/DC	

Example:
R-RL-M0-01-G
Red illuminated Mushroom operator with 1N.C. contact & 24V bulb.

Illuminated Mushroom Pushbutton



Operator Only		
MOMENTARY	Green	R-GL-MO
	Red	R-RL-MO
	List \$	\$7.00
Maintained Push/Pull	Green	R-GL-MA
	Red	R-ESTOP-L
	List \$	\$10.00

		Single Contact		Double Contacts				
								
Part #	1 Open Contact -* 10	1 Closed Contact -* 01	2 Open Contacts -* 20	2 Closed Contacts -* 02	1 Closed, 1 Open Contacts -* 11	Incandescent Bulb Voltage		
	List	List	List	List	List	- ^	Voltage	
R-GL-MO-*^A	\$18.50	\$18.50	\$23.50	\$23.50	\$23.50	M	12 V AC/DC	
R-RL-MO-*^A	\$18.50	\$18.50	\$23.50	\$23.50	\$23.50	G	24 V AC/DC	
						O	48 V AC/DC	
R-GL-MA-*^A	\$21.50	\$21.50	\$26.50	\$26.50	\$26.50	A	110 V AC/DC	
R-ESTOP-L-*^A	\$21.50	\$21.50	\$26.50	\$26.50	\$26.50	C	220V AC	

Example:
R-GL-2-10-A
Green illuminated 2 Position selector with 1N.O. contact & 110V bulb.

Illuminated Selector Switches



Operator Only		
2 Position	Green	R-GL-2
	Red	R-RL-2
	Yellow	R-YL-2
3 Position	Green	R-GL-3
	Red	R-RL-3
	Yellow	R-YL-3
List \$	\$10.00	

		Single Contact		Double Contacts				
								
Part #	1 Open Contact -* 10	1 Closed Contact -* 01	2 Open Contacts -* 20	2 Closed Contacts -* 02	1 Closed, 1 Open Contacts -* 11	Incandescent Bulb Voltage		
	List	List	List	List	List	- ^	Voltage	
R-GL-2-*^A	\$21.50	\$21.50	\$26.50	\$26.50	\$26.50	M	12 V AC/DC	
R-RL-2-*^A	\$21.50	\$21.50	\$26.50	\$26.50	\$26.50	G	24 V AC/DC	
R-YL-2-*^A	\$21.50	\$21.50	\$26.50	\$26.50	\$26.50	O	48 V AC/DC	
						A	110 V AC/DC	
R-GL-3-*^A			\$26.50	\$26.50	\$26.50	C	220V AC	
R-RL-3-*^A			\$26.50	\$26.50	\$26.50			
R-YL-3-*^A			\$26.50	\$26.50	\$26.50			

Emergency Stopbutton & Stations

Enclosed E-Stop Stations Push Pull



Description
Plastic
Aluminum

Assembled Units

Part #	1 Normally Closed Contact -* 01	2 Normally Closed Contacts -* 02	1 Closed & 1 Open Contacts -* 11
R-R-PP-* -P	\$38.00	\$43.00	\$43.00
R-R-PP-* -A	\$46.00	\$51.00	\$51.00

Enclosed E-Stop Stations Key to Release



Description
Plastic
Aluminum

Part #	1 Normally Closed Contact -* 01	2 Normally Closed Contacts -* 02	1 Closed & 1 Open Contacts -* 11
R-ESTOPKEY-* -P	\$44.00	\$49.00	\$49.00
R-ESTOPKEY-* -A	\$52.00	\$55.00	\$55.00

Enclosed E-Stop Stations Twist to Release



Description
Plastic
Aluminum

Part #	1 Normally Closed Contact -* 01	2 Normally Closed Contacts -* 02	1 Closed & 1 Open Contacts -* 11
R-ESTOP-* -P	\$38.00	\$43.00	\$43.00
R-ESTOP-* -A	\$46.00	\$51.00	\$51.00

Emergency Palm Pushbutton

Description	Part #	List Price	Illuminated Part #	List Price
Maintained	060EPAR	\$130.00	060EPADR	\$156.00
Momentary	060EPR	\$115.00	060EPDR	\$138.00
Palm Button Enclosure	060S (GREY)	\$12.00	060SG (Yellow)	\$12.00



Mechanical Latch on Maintained Palm Buttons

UL, CSA, CE NEMA 4, IP65, 600V, 10 Amp Thermal Current, 6 Amp 110V, 3A 220V Make & Break Current.

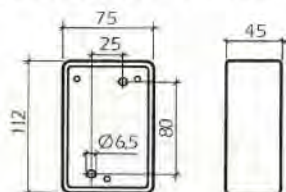

Enclosure

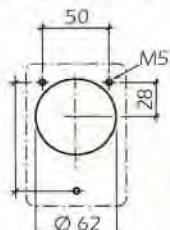

Mounting Holes

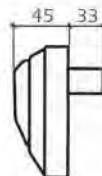

Side View





Side View

NEMA 1 Rated Dual Start / Stop Momentary Pushbuttons

(Boot Fits R-S-STPL Version)				Assembled Pushbuttons with 1 N.O. + 1 N.C. Contacts			
Operator only							Extended
	Part #	R-S-ST	R-S-STPL	BSC-DT Boot	Part #	R-S-ST-11	R-S-STPL-11-* (includes bulb)
List Price	\$5.00	\$6.00	\$6.00	List Price	\$15.00	\$24.00	\$12.00

"R" - Series Selector Switches

Selector Switch (Short Lever)		Operator Only	
 Two Position (Short Lever)	Two Position	Maintained	R-2M
		Spring Return	R-2R
	Three Position	Maintained	R-3M
		Spring Return to Center	R-3R
		Spring Return Left to Center	R-3SLeft
		Spring Return Right to Center	R-3SRight
List \$			\$9.00

Selector Switch (Long Lever)		Operator Only	
 Two Position	Two Position	Maintained	RL-2M
		Spring Return to Center	RL-2R
	Three Position	Maintained	RL-3M
		Spring Return to Center	RL-3R
		Spring Return Left to Center	RL-3SLeft
		Spring Return Right to Center	RL-3SRight
List \$			\$9.00

Keyed Selector Switch (Maintained)		Operator Only	
	Two Position	Key Removal Both Positions	R-2KEY
		Key Removal Left Position	R-2KEYL
		Key Removal Right Position	R-2KEYR
	Three Position	All Positions	R-3KEY-AP
		Center Position	R-3KEY-C
		Left & Right Positions	R-3KEY-RL
Left Position		R-3KEY-L	
Right Position	R-3KEY-R		
List \$			\$12.00

Keyed Selector Switch (Momentary)		Operator Only	
	Two Pos.	Spring Return Right to Left	R-KEYC-2M
		Key Removal Left	R-KEYC-2M
	Three Position	Spring Return To Center	R-3M
		Key Removal Center	R-3KEY-CSTOC
List \$			\$12.00

Assembled Units	Single Contact	Double Contact
		
Part #	1 Normally Open Contact -* 10	2 Normally Open Contacts -* 20
R-2M-*	\$14.00	
R-2R-*	\$14.00	
R-3M-*		\$19.00
R-3R-*		\$19.00
R-3SLeft-*		\$19.00
R-3SRight-*		\$19.00

Assembled Units	Single Contact	Double Contact
		
Part #	1 Normally Open Contact -* 10	2 Normally Open Contacts -* 20
RL-2M-*	\$14.00	
RL-2R-*	\$14.00	
RL-3M-*		\$19.00
RL-3R-*		\$19.00
RL-3SLeft-*		\$19.00
RL-3SRight-*		\$19.00

Assembled Units	Single Contact	Double Contact
		
Part #	1 Normally Open Contact -* 10	2 Normally Open Contacts -* 20
R-2KEY-*	\$17.00	
R-2KEYL-*	\$17.00	
R-2KEYR-*	\$17.00	
R-3KEY-AP-*		\$22.00
R-3KEY-C-*		\$22.00
R-3KEY-RL-*		\$22.00
R-3KEY-L-*		\$22.00
R-3KEY-R-*		\$22.00

Assembled Units	Single Contact	Double Contact
		
Part #	1 Normally Open Contact -* 10	2 Normally Open Contacts -* 20
R-KEYC-*	\$17.00	
R-3KEY-CSTOC-*		\$22.00
R-3KEY-CSTRT-*		\$22.00

● NEMA 4

● IP65

● c us

●

Momentary Flush Pushbutton	Operator Only
	Green R-G
	Red R-R
	Black R-B
	Yellow R-Y
	Blue R-BL
	White R-W
	Arrow R-AR
List \$	\$4.00

	Single Contact		Double Contacts		
Part #	1 Normally Open Contact -^ 10	1 Normally Closed Contact -^ 01	2 Normally Open Contacts -^ 20	2 Normally Closed Contacts -^ 02	1 Closed & 1 Open Contacts -^ 11
R-G-*	\$9.00	\$9.00	\$14.00	\$14.00	\$14.00
R-R-*	\$9.00	\$9.00	\$14.00	\$14.00	\$14.00
R-B-*	\$9.00	\$9.00	\$14.00	\$14.00	\$14.00
R-Y-*	\$9.00	\$9.00	\$14.00	\$14.00	\$14.00
R-BL-*	\$9.00	\$9.00	\$14.00	\$14.00	\$14.00
R-W-*	\$9.00	\$9.00	\$14.00	\$14.00	\$14.00
R-AR-*	\$9.00	\$9.00	\$14.00	\$14.00	\$14.00

Momentary Extended Pushbutton	Operator Only
	Green R-G-E
	Red R-R-E
	Black R-B-E
	Yellow R-Y-E
	Blue R-BL-E
	White R-W-E
	Arrow R-AR-E
List \$	\$4.00

	Single Contact		Double Contacts		
Part #	1 Normally Open Contact -^ 10	1 Normally Closed Contact -^ 01	2 Normally Open Contacts -^ 20	2 Normally Closed Contacts -^ 02	1 Closed & 1 Open Contacts -^ 11
R-G-E-*	\$9.00	\$9.00	\$14.00	\$14.00	\$14.00
R-R-E-*	\$9.00	\$9.00	\$14.00	\$14.00	\$14.00
R-B-E-*	\$9.00	\$9.00	\$14.00	\$14.00	\$14.00
R-Y-E-*	\$9.00	\$9.00	\$14.00	\$14.00	\$14.00
R-BL-E-*	\$9.00	\$9.00	\$14.00	\$14.00	\$14.00
R-W-E-*	\$9.00	\$9.00	\$14.00	\$14.00	\$14.00
R-AR-E-*	\$9.00	\$9.00	\$14.00	\$14.00	\$14.00

40mm Momentary Mushroom Pushbutton	Operator Only
	Green R-G-M
	Red R-R-M
	Black R-B-M
	Yellow R-Y-M
	Blue R-BL-M
	White R-W-M
List \$	\$6.00

	Single Contact		Double Contacts		
Part #	1 Normally Open Contact -^ 10	1 Normally Closed Contact -^ 01	2 Normally Open Contacts -^ 20	2 Normally Closed Contacts -^ 02	1 Closed & 1 Open Contacts -^ 11
R-G-M-*	\$11.00	\$11.00	\$16.00	\$16.00	\$16.00
R-R-M-*	\$11.00	\$11.00	\$16.00	\$16.00	\$16.00
R-B-M-*	\$11.00	\$11.00	\$16.00	\$16.00	\$16.00
R-Y-M-*	\$11.00	\$11.00	\$16.00	\$16.00	\$16.00
R-BL-M-*	\$11.00	\$11.00	\$16.00	\$16.00	\$16.00
R-W-M-*	\$11.00	\$11.00	\$16.00	\$16.00	\$16.00

Extra Contact Blocks		Terminal Marking Numbers	Maximum Six Poles Per Operator		
		3 - 4	10A Contact Block	Part #	List Price
Side View 3 Max. Blocks		13 - 14	Normally Open	R-NO	\$5.00
Stackable Contacts		1 - 2	Normally Closed	R-NC	\$5.00
Rear View		21 - 22	Normally Closed	R-NC2122	\$5.00
3 MAX. Contact Blocks, Per Row (2 rows) = 6 Poles Max.		1 - 2	N.C. with Gold Flash	R-NC-G	\$12.00
Row: 1 2		3 - 4	N.O. with Gold Flash	R-NO-G	\$12.00
Gold Contacts 17V, 10mA Min AC/DC					



A Secure + Safe System Versus Snap on Contacts

Assembled Units



	Operator Only
Red	R-R-PP
List \$	\$13.00

	Single Contact		Double Contacts		
	1 Normally Open Contact	1 Normally Closed Contact	2 Normally Open Contacts	2 Normally Closed Contacts	1 Closed & 1 Open Contacts
Part #	-* 10	-* 01	-* 20	-* 02	-* 11
R-R-PP-*	\$18.00	\$18.00	\$23.00	\$23.00	\$23.00



	Operator Only
Red	R-ESTOP
List \$	\$13.00

	Single Contact		Double Contacts		
	1 Normally Open Contact	1 Normally Closed Contact	2 Normally Open Contacts	2 Normally Closed Contacts	1 Closed & 1 Open Contacts
Part #	-* 10	-* 01	-* 20	-* 02	-* 11
R-ESTOP-*	\$18.00	\$18.00	\$23.00	\$23.00	\$23.00



	Operator Only
Red	R-ESTOP-60
List \$	\$13.00

	Single Contact		Double Contacts		
	1 Normally Open Contact	1 Normally Closed Contact	2 Normally Open Contacts	2 Normally Closed Contacts	1 Closed & 1 Open Contacts
Part #	-* 10	-* 01	-* 20	-* 02	-* 11
R-ESTOP-60-*	\$18.00	\$18.00	\$23.00	\$23.00	\$23.00



	Operator Only
Red	R-ESTOP-KEY
List \$	\$19.00

	Single Contact		Double Contacts		
	1 Normally Open Contact	1 Normally Closed Contact	2 Normally Open Contacts	2 Normally Closed Contacts	1 Closed & 1 Open Contacts
Part #	-* 10	-* 01	-* 20	-* 02	-* 11
R-ESTOP-KEY-*	\$24.00	\$24.00	\$29.00	\$29.00	\$29.00

Extra Contact Blocks

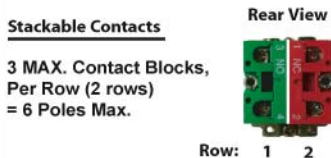

Terminal Marking Numbers	Maximum Six Poles Per Operator			
	10A Contact Block	600A	Part #	List Price
3 - 4	Normally Open		R-NO	\$5.00
13 - 14	Normally Open		R-NO1314	\$5.00
1 - 2	Normally Closed		R-NC	\$5.00
21 - 22	Normally Closed		R-NC2122	\$5.00
1 - 2	N.C. with Gold Flash		R-NC-G	\$12.00
3 - 4	N.O. with Gold Flash		R-NO-G	\$12.00

Gold Contacts 17V, 10mA Min AC/DC

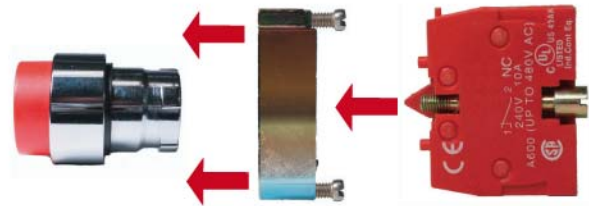

Metal Chrome Bezel Steel Block Holder Included with operators Bolt-On Contact Block

A Secure + Safe System Versus Snap on Contacts



LED Pilot Light's Modular 22mm + 30mm

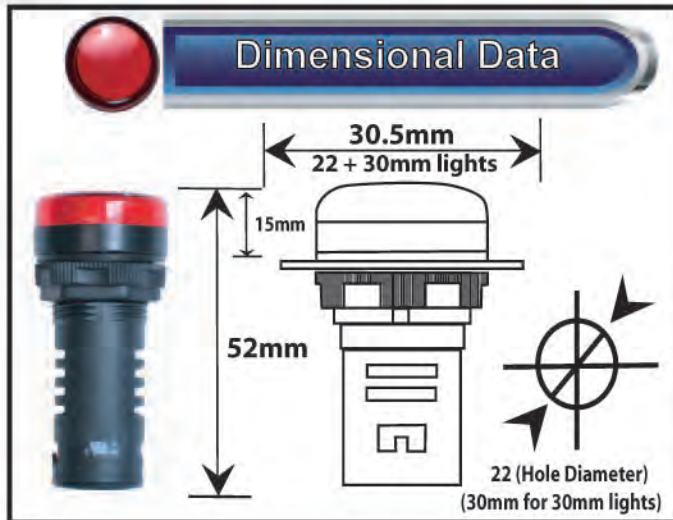

List Price \$22.00 Per Light
100 + pcs. mix qty. \$16.00 Per Light

Part Numbers	Colors
B22LED-R-*	RED
B22LED-G-*	GREEN
B22LED-Y-*	YELLOW
B22LED-B-*	BLUE
B22LED-W-*	WHITE

* Add Voltage Suffix:

(*) Add Suffix for Colors	
-A	110VAC
-C	220VAC
-G	24VAC/DC
-O	48VAC/DC
-D	380VAC
-M	12VAC/DC

For 30mm LED pilot light simply Add suffix "30" to end of part # - Add \$9 to list.

Example - B22LED-R-A-30 \$31.00 List.



APPROVALS

EN 60947-5-1

-Operational Temperature - -13° + 130°F

-Protection Degree NEMA 4X - IP65

-Current Draw -Ie MA<80- (6, 12v)
20- (24, 48), 110, 220V.

-Brightness = -cd/M² ≥ 60

-AC Rated Frequency = -50/60 HZ

-Saddle Clamp Screw Terminals.

Mounting - 22mm or 30mm hole diameter.

Discount Schedule "B"









"R" - Series Accessories

- NEMA 4
- IP65
- cULus
- CE
- 10 Amp 600 VAC

 NEMA 4X Rubber Boot Recommended for wash down Applications	Boot Colors \$4.00	Non - Illuminated PART #
	CLEAR	R-BOOT
	GREEN	R-GBOOT
	RED	R-RBOOT
	AMBER	R-ABOOT
	BLUE	R-BBOOT

Emergency Stop Name Plates \$4.00		
	Diameter Part #	
	60mm Plastic	R-60PESTOP
	90mm Plastic	R-90PESTOP
	60mm Aluminum	R-60AESTOP
	90mm Aluminum	R-90AESTOP

Illuminated Pushbuttons Clear BOOT Part # R-BOOTCL

 Block Holder	Spare Steel Block Holder (for Non-illuminated Devices) R-Block \$2.00
 Incandescent spare bulbs \$4.00	Part # includes Voltage (AC/DC) R-BULB-6V R-BULB-12V R-BULB-24V R-BULB-48V R-BULB-130V
 Spade Connection	Quick connect (male) for "Fast - On" "QC" wiring method Part # R-QC \$0.50 List Price
 Spare Key	Part# R-Key \$2.00 List
 Padlock Cover	Part # R-Cover for Pushbuttons ONLY \$6.00 List
 30 to 22mm Hole Adaptor	Part # R-30 - 22 \$2.00 List
 Bulb Remover	Part # R-TOOL \$4.00 List

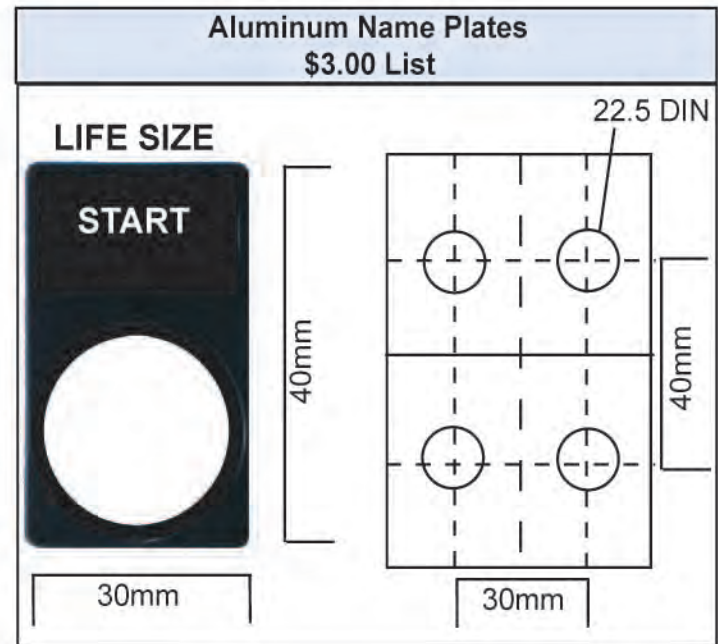

LEGEND PART #	\$3.00 List
R-OFF	R-STOP START
R-STOP	R-OPEN
R-START	R-RESET
R-FOWARD	R-CLOSE
R-REVERSE	R-HIGH LOW
R-UP	R-AUTO
R-DOWN	R-HAND
R-HAND OFF AUTO	R-FAST
R-EMERGENCY STOP	R-SLOW
R-OFF ON	R-HIGH
R-INCH	R-LOW
R- Blank	R-Run

“R” Series 22mm Pushbuttons Accessories

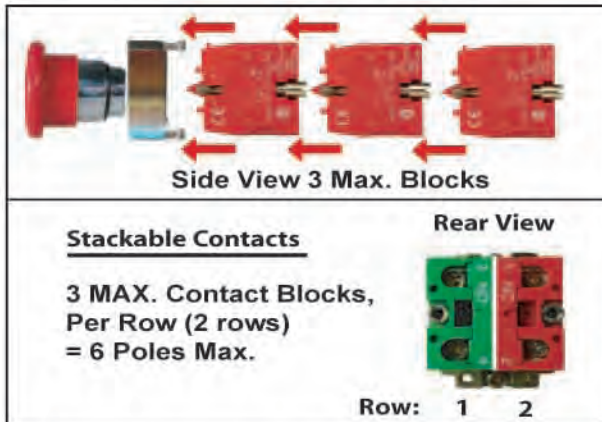
NEMA 4
IP65

Terminal Marking Numbers	Contact Block	10A 600 A	Part #	List Price
3 - 4	Normally Open		R-NO	\$5.00
13 - 14	Normally Open		R-NO1314	\$5.00
1 - 2	Normally Closed		R-NC	\$5.00
21 - 22	Normally Closed		R-NC2122	\$5.00
1 - 2	N.C. with Gold Flash		R-NC-G	\$12.00
3 - 4	N.O. with Gold Flash		R-NO-G	\$12.00



Incandescent Lights (Includes Socket)
Add * Suffix to designate voltage.

Description	Part #	List Price
Bulb and Socket	R-T-*	\$6.50

* Add to end of part #

AC/DC Voltage	* Suffix
12	-M
24	-G
48	-O
110	-A
220	-C

Pushbuttons Only

Light Sockets + LED Bulb
Add * Suffix to designate voltage.

Description	Part #	List Price
Exclusively for Illuminated Pushbuttons		
LED - Green	R-G-LED-*	\$11.00
LED - Red	R-R-LED-*	\$11.00
LED - Yellow	R-Y-LED-*	\$11.00
LED - Blue	R-B-LED-*	\$24.00

* Add to end of part #

AC/DC Voltage	* Suffix
12	-M
24	-G
48	-O
110	-A

Pushbutton Stations - IP65

R-3PBP

R-1PBA

Refer to page 162 for factory assembled stations.

22mm Holes	Part #	List Price
Thermoplastic		
1	R-1PBP	\$14.00
2	R-2PBP	\$15.00
3	R-3PBP	\$16.00
4	R-4PBP	\$21.00
1(yellow)	R-1PBPY	\$14.00

R-1PBPY

R-2PPBA

Aluminum Die Cast		
1	R-1PBA	\$20.00
2	R-2PBA	\$24.00
3	R-3PBA	\$24.00
4	R-4PBA	\$29.00