

Altech Corp.®

Serving the Automation & Control Industry since 1984

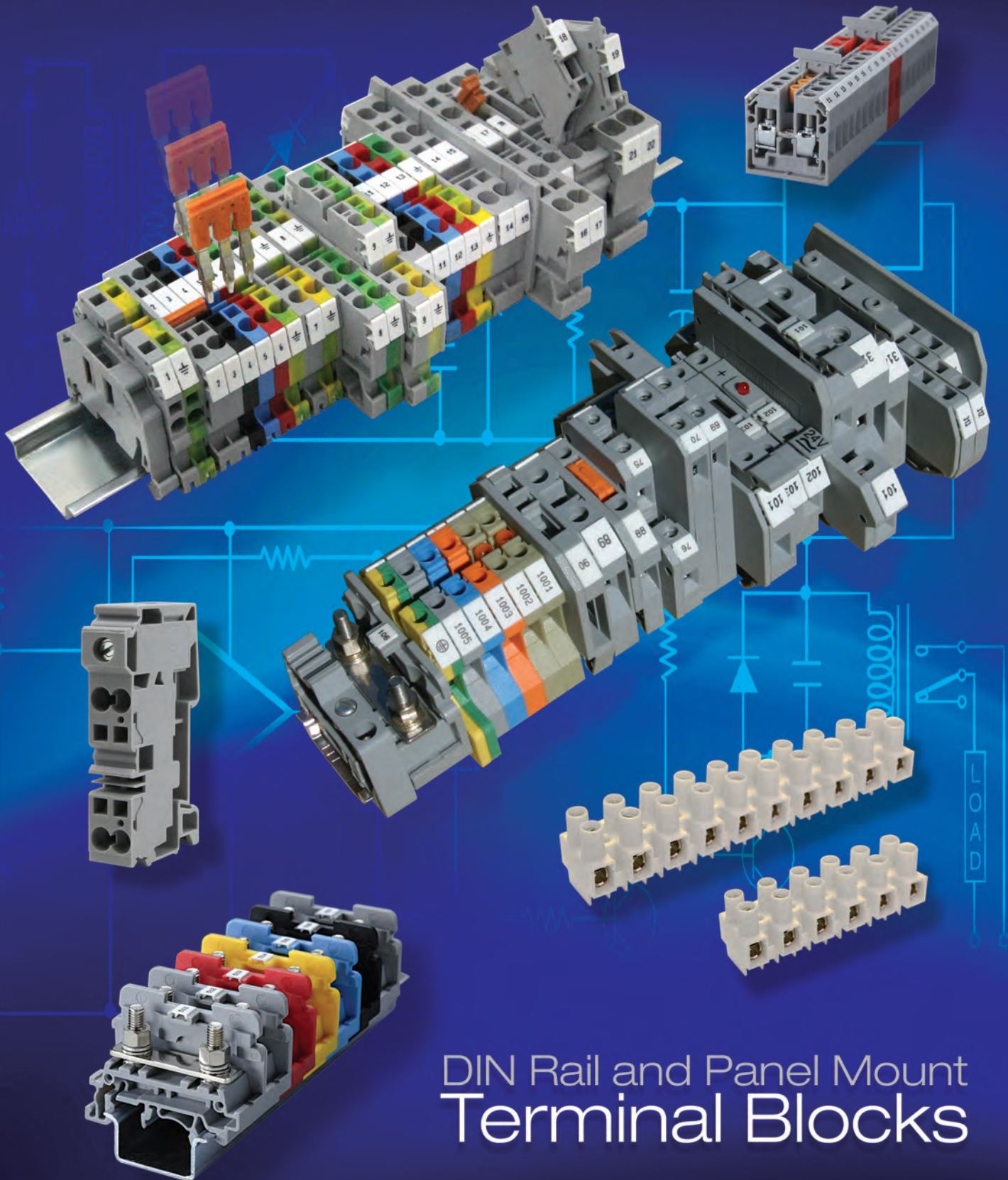

ISO 9001
QMI-SAI Global



DIN Rail and Panel Mount Terminal Blocks

Altech Corp.®

Since 1984, Altech Corporation has grown to become a leading supplier of automation and industrial control components. Headquartered in Flemington, NJ, Altech has an experienced staff of engineering, manufacturing and sales personnel to provide the highest quality products with superior service. This is the Altech Commitment!

With experienced Product Engineers and Customer Service personnel, Altech provides solutions to your most pressing application challenges. All with one thought in mind - to ensure that we solve your problem the first time!



Altech's Commitment

Altech's Automation and Control components meet applicable national and international standards, such as UL, NEC, CSA, IEC and VDE. Altech provides these products with superior customer service and delivery through a ISO 9001 Quality Management system, which stresses continuous process improvement. We perform these services with honesty and integrity. All Altech employees are trained in this Quality Management System and are dedicated to achieve these goals. Altech's quality system has been ISO approved since 1999.



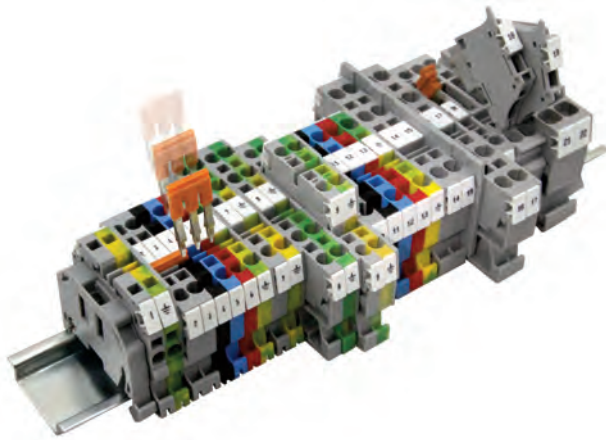

Screw Clamp Terminal Blocks

Introduction4
Selection Guide5
Feed Through Terminal Blocks
 • Single Level.....6-8
 • Multi Connection.....9
 • Double Level10-13
 • Triple Level.....14-15
 • Ground/ Earth.....16-17

Fuse Terminal Blocks

• 5x20mm/ 5x25mm Fuse.....18-19
 • Double Level Fuse Terminal.....20-21
 • 6.35x25.4mm (¼" x 1") Fuse22
 • Component Carrier23
 • Fuse Holder.....24-25

Disconnect & Test Terminal Blocks

• Slider Style26-27, 30
 • Blade Style28-29
 • Lever Style31

Power Distribution Terminal Blocks

• Multi I/O.....32-34
 • Hybrid Spring/ Screw.....35
 • Distribution / Grounding System.....36

Special Application Terminal Blocks

• 1000V High Voltage.....37
 • Thermocouple38
 • Tab Connection39
 • Spring Loaded.....40-41
 • Electronic Components42-47

Accessories Screw Terminal Blocks.....48-49



Stud/ Ring Lug Terminal Blocks

Introduction50
Selection Guide51
 • Ring Lug Barrier Terminal Blocks52-53
 • Ring Lug Stud Terminal Blocks54-55
 • Ring Lug Hinge Terminal Blocks56-57
 • Ring Lug Power Terminal Blocks.....58-59
 • High Current Power Terminal Blocks.....60
 • Accessories Stud/ Ring Lug Terminal Blocks ...61



Spring Clamp Terminal Blocks

Introduction62
Selection Guide63
CX Series
 • Single Level Feed Through64-65
 • Multi Connection65-67
 • Ground/ Earth.....68-70
 • Double Level71
 • Electronic Component.....72-73
 • 5x20mm/ 5x25mm Fuse74
 • Component Carrier.....75
 • Disconnect.....76
 • Side Entry77
 • Pluggable78
 • Hybrid Distribution79

Angular Terminal Blocks

• Feed-Through.....80
 • Multi-Connection81
 • Multi-Level.....82-83
 • Ground/ Earth.....84-85

Accessories Spring Terminal Blocks86-87

Mini/ Panel Mount Terminal Blocks

Introduction/ Selection Guide88
Screw Clamp Terminal Blocks
 • 15mm Mini Rail.....89
 • Panel Mount90

Spring Clamp Terminal Blocks

• 15mm Mini Rail.....91
 • Panel/ DIN Rail Mount.....92
 • Micro Panel Mount93

High Temperature Ceramic94

Terminal Strips – Eurostrip® Style

Introduction/ Selection Guide95
 • 300V Flat Base, Feed Through96-97
 • 600V Standoff Feet, Feed Through.....98-99
 • Pluggable100-101
 • Middle Barrier, Feed Through102-103
 • Accessories Terminal Strips104-105

Mounting & Marking – Accessories

• DIN Rail.....106-107
 • Support Brackets/ Mounting Clips108
 • End Stops.....109
 • Group Identification Markers.....110
 • Marking Tags/ Warning Labels.....111
 • Plotter & Marking System112-113

Ferrules

Introduction114-115
 • UL Ferrules116-117
 • Crimping Tools (UL Ferrules).....118-120
 • DIN Standard Ferrules120-124
 • Crimping Tools (DIN Ferrules).....125-127

INDEX.....128-133

TERMS & CONDITIONS134

OVERVIEW

SCREW TERMINAL BLOCKS

INTRODUCTION

SCREW CLAMP CONNECTION TECHNOLOGY



- Maximum wiring efficiency and reliability
- Supplied with open clamps ready to accept wires
- No wire preparation necessary (with/ without ferrule)
- Vibration resistant/ Gas-tight connection
- For very larger wire sizes (up to 250 kcmil)
- Designed for most stringent requirements
- Simple connection with standard flat head screwdriver



60947-7-1

MATERIAL SPECIFICATIONS

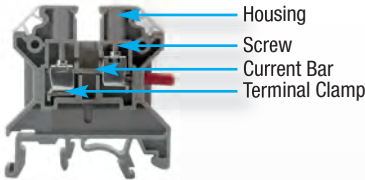

Current Carrying Metal *Corrosion free material*

- Clamp: zinc chromate passivated steel
- Screw: zinc chromate passivated steel
- Current Bar: nickel plated copper alloy / tin plated copper

Terminal Block Housing

- Polyamide PA66 Housing
- Self-extinguishing
- High mechanical strength

Polyamide 66 Specifications

Upper Temperature Limit: 105°C

Lower Temperature Limit: -50°C

Flammability UL94: V2/ V0

Volume Resistivity: 10¹² Ω cm

Surface Resistivity: 10¹⁰ Ω

INSTALLATION GUIDELINES

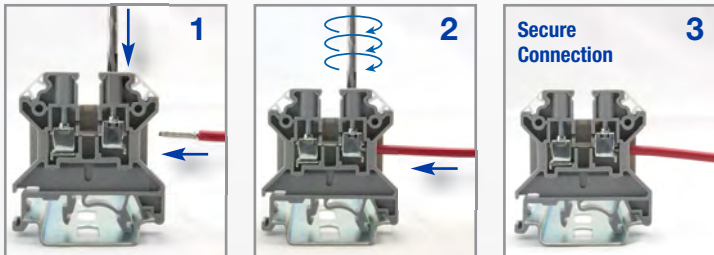

- 1 Insert Wire into open clamp
- 2 Tighten screw to specified torque
- 3 Remove Screwdriver, screw terminal is closed with locking feature for a reliable/ safe connection

SCREW CLAMP ACCESSORIES AND FEATURES

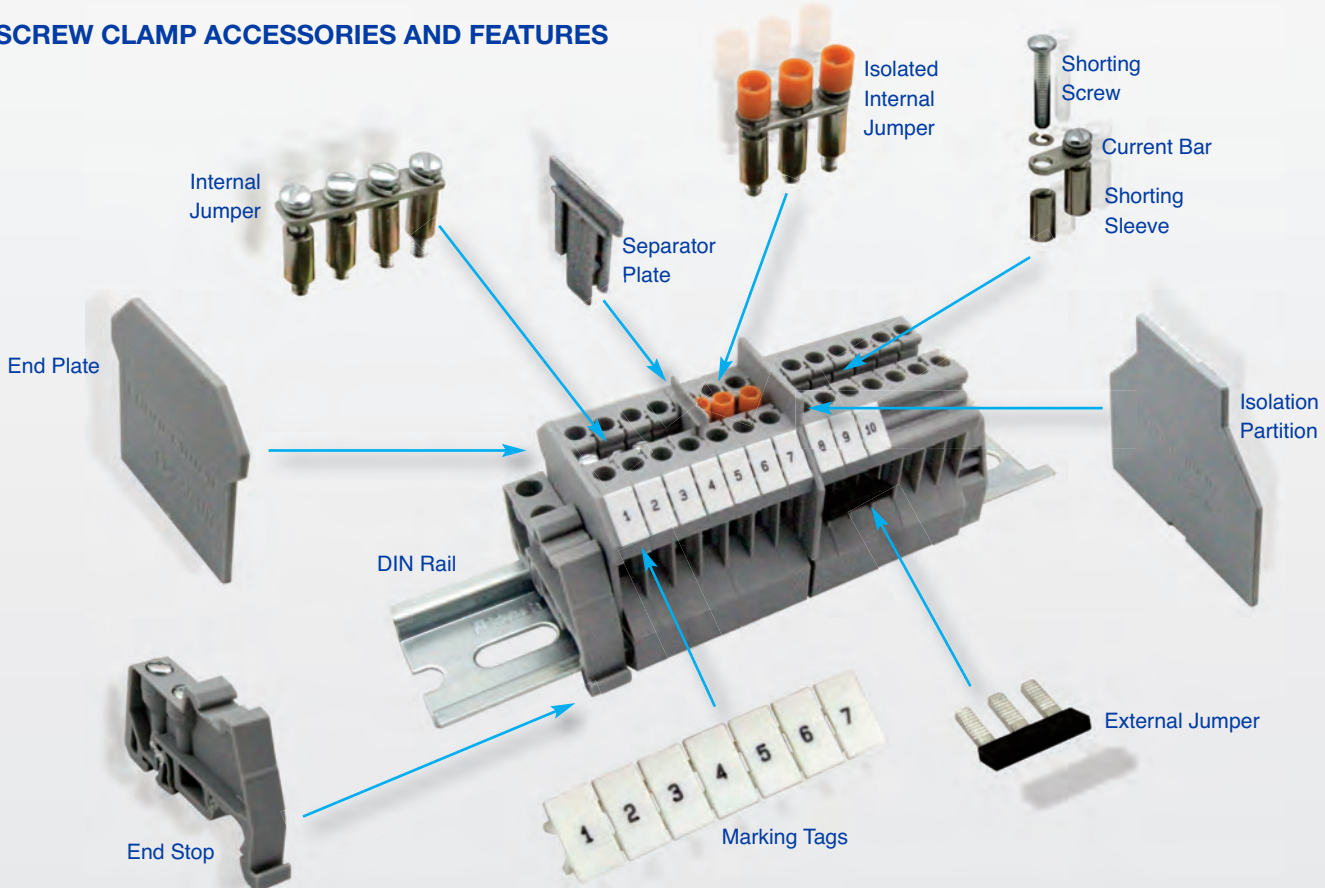

Feed Through Terminal Blocks

- Up to 240A
- Multi-Connection Terminals
- Double Level Terminal
- Triple Level Terminals
- Ground Blocks
- Wide range of accessories
- All standard colors

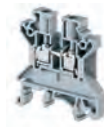

Feed Through
page 6-8



Multi-Connection
page 9

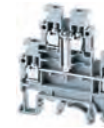

Double Level
page 10-12

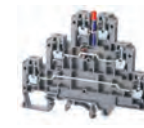

Triple Level
page 14-15



Ground / Earth
page 16-17

Fuse Terminal Blocks

- 1/4" x 1" Fuse Terminal Blocks
- 5x20mm/ 5x25mm Fuse Terminal Blocks
- Double level versions
- Component Carrier for flexible requirements
- 10x38, CC, J-Type Fuse Holder



**5x20mm / 5x25mm
CF4U / CF4SP**
page 18-19



**Double Lever
DDFL4U**
page 20-21



**1/4"x1"
CAFL4U**
page 22

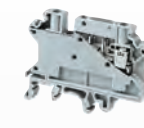

**Component Carrier
CCC4U**
page 23



Fuse Holder
page 24-25

Disconnect & Test Terminal Blocks

- Slider Style
- Blade/ Knife Style
- Lever Style
- Accessories and matching Feed Through terminals



**Slider Style
CDS6U**
page 26-27

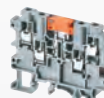

**Blade Style
CKT4U**
page 28



**Blade Style
CKT4SP**
page 29



**Slider Style
CDDTU**
page 30



**Lever Style
CSDL4U**
page 31

Power Distribution Terminal Blocks

- Various I/O configurations
- Up to 150A
- Compact Hybrid Distribution Block



CDB Series
page 32-33



CMDB Series
page 34



Hybrid CXDB Series
page 35



Distribution/Grounding
page 36

Special Application Terminal Blocks

- Spring Loaded Terminals for high vibration applications
- 1000V High Voltage Terminals
- Thermocouple Terminals
- Tab Connection Terminals
- Electronic Components Terminals



**1000V High Voltage
CHV Series**
page 37



**Thermocouple
CTT2.5U Series**
page 38

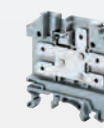

**Tab Connection
CTC Series**
page 39

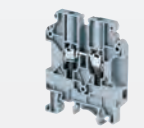

**Spring Loaded
USC Series**
page 36-37



**Electronic
Components**
page 42-47

Accessories

- Internal Jumpers (Uninsulated, Insulated)
- Endplates
- Partition/ Separator Plates
- Protective Covers
- End Stops



Jumpers
page 48



Endplates, Separators, End Stops, Covers, etc.
page 49

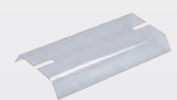
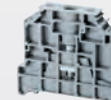

HIGHLIGHTS

FEATURES

- Altech CTS Series of Universal Screw Terminal Blocks featuring global standards
- Universal mounting foot for easy snap onto common DIN rail profiles
- Screw-type jumper system
- Current Ratings up to 240A

APPLICATIONS

- Ex & IECEx approvals for use in potentially explosive areas
- Control, Automation applications
- Power Distribution

CTS2.5U-N



CTS4U-N



CTS6U



Dimensions & Weight

	CTS2.5U-N	CTS4U-N	CTS6U
Width	5 mm	6 mm	8 mm
Length	43 mm	43 mm	43 mm
Height w/ DIN Rail	35 x 7.5 mm 35 x 15 mm	46.2 mm 53.7 mm	47.8 mm 55.5 mm
Weight per piece	6.2 g	7.6 g	13.5 g

Technical Data/Ratings

Approvals	CTS2.5U-N		CTS4U-N		CTS6U	
	UL US E220514	SP US 60947-7-1	UL US E220514	SP US 60947-7-1	UL US E220514	SP US 60947-7-1
Wire Size (solid / stranded)	22-12 AWG	0.2-2.5 mm ²	22-10 AWG	0.2-4 mm ²	22-8 AWG	0.5-6 mm ²
Voltage Rating	600 V	1000V AC/DC	600 V	1000V AC/DC	600 V	1000V AC/DC
Current Rating	25 A	24 A	35 A	32 A	50 A	41 A
Torque	7 lb-in	0.4 Nm	7 lb-in	0.5 Nm	14 lb-in	0.8 Nm
Insulation Material	Polyamide 66		Polyamide 66		Polyamide 66	

Installation Instructions

	CTS2.5U-N	CTS4U-N	CTS6U
Wire Stripping Length	8 mm	8 mm	9 mm
Screwdriver	Flat Head 0.5 x 3.0 mm	Flat Head 0.6 x 3.5 mm	Flat Head 0.8 x 4.0 mm

Terminal Blocks

	Cat. No.	Std. Pk.	Cat. No.	Std. Pk.	Cat. No.	Std. Pk.
Grey (standard)	CTS2.5U-N	100	CTS4U-N	100	CTS6U	100
Red R	CTS2.5U-N/R	100	CTS4U-N/R	100	CTS6U/R	100
Blue BU	CTS2.5U-N/BU	100	CTS4U-N/BU	100	CTS6U/BU	100
Black BL	CTS2.5U-N/BL	100	CTS4U-N/BL	100	CTS6U/BL	100
Orange O	CTS2.5U-N/O	100	CTS4U-N/O	100	CTS6U/O	100
Green G	CTS2.5U-N/G	100	CTS4U-N/G	100	CTS6U/G	100
Yellow Y	CTS2.5U-N/Y	100	CTS4U-N/Y	100	CTS6U/Y	100
White W	CTS2.5U-N/W	100	CTS4U-N/W	100	CTS6U/W	100



Mounting Handle

Mounting handle is used for mounting 10 terminal blocks on a DIN rail, thus saving considerable time. Specially designed pins in the mounting handle grip the terminal blocks when pressed against entry.

Cat. No. Terminal Block Std. Pk.

MH2.5	CTS2.5U-N	1
MH4	CTS4U-N	1



Accessories

	Cat. No.	Std. Pk.	Cat. No.	Std. Pk.	Cat. No.	Std. Pk.	
End Plate	EP2.5/4UN	50	EP2.5/4UN	50	EP6/10U	50	
Partition Plate	PP2.5/4UN	50	PP2.5/4UN	50	PP6/10U	50	
Separator Plate	SP2.5/4UN	100	SP2.5/4UN	100	SP6/10U	100	
DIN Rail	2511120 CA701-15/S 2511160	20 20 10	2511120 CA701-15/S 2511160	20 20 10	2511120 CA701-15/S 2511160	20 20 10	
End Stop	CA702 CA802 CA202	50 50 25	CA702 CA802 CA202	50 50 25	CA702 CA802 CA202	50 50 25	
Internal Jumper	2 pole 3 pole 4 pole 10 pole 100 pole	CA721/2 CA721/3 CA721/4 CA721/10 CA721/100	100 100 100 10 10	CA722/2 CA722/3 CA722/4 CA722/10 CA722/100	100 100 50 10 10	CA723/2 CA723/3 CA723/4 CA723/10 -	100 50 50 10 -
Insulated Internal Jumper	2 pole 3 pole 4 pole 10 pole 100 pole	CA741/2 CA741/3 CA741/4 CA741/10 CA741/100	100 100 100 10 10	CA742/2 CA742/3 CA742/4 CA742/10 CA742/100	100 100 100 10 10	CA743/2 CA743/3 CA743/4 CA743/10 -	100 50 50 10 -
External Jumper	2 pole 3 pole 4 pole 10 pole	CA717/2 CA717/3 CA717/4 CA717/10	100 100 100 20	CA714/2 CA714/3 CA714/4 CA714/10	100 100 100 20	CA710/2 CA710/3 CA710/4 CA710/10	100 50 50 20
Test Socket	CA707/TS/01	100	CA707/TS/01	100	CA707/TS/05	100	
Marking Tag	MT5	1 Pk. (100 tags)	MT6	1 Pk. (100 tags)	MT8	1 Pk. (100 tags)	

CTS10U

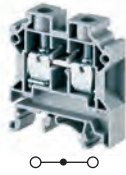

CTS16U



CTS25UN



CTS35UN



Dimensions & Weight

Width	10 mm	12 mm	12 mm	16 mm
Length	43 mm	43 mm	49 mm	50.5 mm
Height w DIN Rail	35 x 7.5 mm 35 x 15 mm	47.8 mm 55.5 mm	47.8 mm 55.5 mm	57.2 mm 64.7 mm
Weight per piece	16.5 g	25.5 g	35.5 g	50.5 g

Technical Data/Ratings

Approvals										
Wire Size (solid / stranded)	16-6 AWG	22-6 AWG	0.5-10 mm ²	20-4 AWG	22-6 AWG	0.2-16 mm ²	14-2 AWG	4-25 mm ²	12-1/0 AWG	4-35 mm ²
Voltage Rating	600 V	600 V	1000V AC/DC	600 V	600 V	1000V AC/DC	600 V	1000V AC/DC	600 V	1000V AC/DC
Current Rating	65 A	65 A	57 A	85 A	70 A	76 A	105 A	101 A	150 A	125 A
Torque	14 lb-in	14 lb-in	1.2 Nm	14 lb-in	14 lb-in	1.2 Nm	30 lb-in	2.0 Nm	50 lb-in	2.5 Nm
Insulation Material	Polyamide 66			Polyamide 66			Polyamide 66		Polyamide 66	

Installation Instructions

Wire Stripping Length	11 mm	12 mm	14 mm	15 mm
Screwdriver	Flat Head 0.8 x 4.0 mm	Flat Head 1.0 x 5.5 mm	Flat Head 1.0 x 5.5 mm	Flat Head 1.0 x 5.5 mm

Terminal Blocks

	Cat. No.	Std. Pk.	Cat. No.	Std. Pk.	Cat. No.	Std. Pk.	Cat. No.	Std. Pk.
Grey (standard)	CTS10U	100	CTS16U	50	CTS25UN	50	CTS35UN	50
Red R	CTS10U/R	100	CTS16U/R	50	CTS25UN/R	50	CTS35UN/R	50
Blue BU	CTS10U/BU	100	CTS16U/BU	50	CTS25UN/BU	50	CTS35UN/BU	50
Black BL	CTS10U/BL	100	CTS16U/BL	50	CTS25UN/BL	50	CTS35UN/BL	50
Orange O	CTS10U/O	100	CTS16U/O	50	CTS25UN/O	50	CTS35UN/O	50
Green G	CTS10U/G	100	CTS16U/G	50	CTS25UN/G	50	CTS35UN/G	50
Yellow Y	CTS10U/Y	100	CTS16U/Y	50	CTS25UN/Y	50	CTS35UN/Y	50
White W	CTS10U/W	100	CTS16U/W	50	CTS25UN/W	50	CTS35UN/W	50

Accessories

	Cat. No.	Std. Pk.	Cat. No.	Std. Pk.	Cat. No.	Std. Pk.	Cat. No.	Std. Pk.
End Plate	EP6/10U	50	-	-	-	-	-	-
Partition Plate	PP6/10U	50	-	-	PP25UN	50	PP35UN	50
Separator Plate	SP6/10U	100	SP6/10U	100	-	-	-	-
DIN Rail	2511120 CA701-15/S 2511160	20 20 10	2511120 CA701-15/S 2511160	20 20 10	2511120 CA701-15/S 2511160	20 20 10	2511120 CA701-15/S 2511160	20 20 10
End Stop	CA702 CA802 CA202	50 50 25	CA702 CA802 CA202	50 50 25	CA702 CA802 CA202	50 50 25	CA702 CA802 CA202	50 50 25
Internal Jumper	2 pole CA724/2 3 pole CA724/3 4 pole CA724/4 10 pole CA724/10 100 pole -	100 50 50 10 -	CA751/2 CA751/3 CA751/4 CA751/10 CA751/100	50 50 50 10 10	CA725/2 CA725/3 CA725/4 CA725/10 CA725/100	50 20 20 10 10	CA771/2 CA771/3 CA771/4 CA771/10 -	50 20 20 10 -
Insulated Internal Jumper	2 pole CA744/2 3 pole CA744/3 4 pole CA744/4 10 pole CA744/10 100 pole -	100 50 50 10 -	CA761/2 CA761/3 CA761/4 CA761/10 CA761/100	100 50 50 10 10	CA745/2 CA745/3 CA745/4 CA745/10 CA745/100	50 20 20 10 10	CA781/2 CA781/3 CA781/4 CA781/10 -	50 20 20 10 -
External Jumper	2 pole CA718/2 3 pole CA718/3 4 pole CA718/4 10 pole CA718/10	100 50 50 20	-	-	-	-	-	-
Test Socket	CA707/TS/05	100	CA707/TS/05	100	CA707/TS/06	100	CA707/TS/06	100
Marking Tag	MT10	1 Pk. (100 tags)	MT12	1 Pk. (100 tags)	MT12	1 Pk. (100 tags)	MT16	1 Pk. (100 tags)

FEED-THROUGH

SCREW TERMINAL BLOCKS

SINGLE LEVEL POWER TERMINAL BLOCKS

HIGHLIGHTS

FEATURES

- DIN Rail and Panel mountable
- Voltage Rating 1000V
- Current Rating up to 240A
- Hex Screw version for easier tightening (NA)
- Auxiliary block for easy plug in

APPLICATIONS

- Power Distribution
- Solar Applications
- **AUX6** auxiliary for indicator light or contactor

CTS50/70N



CTS50/70NA

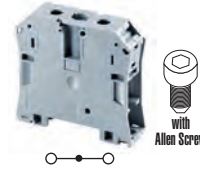

CTS95/120N

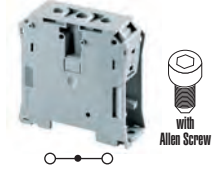

Dimensions & Weight

	CTS50/70N	CTS50/70NA	CTS95/120N
Width	20.5 mm	20.5 mm	27.0 mm
Length	77.3 mm	77.3 mm	84.5 mm
Height w DIN Rail	35 x 7.5 mm 35 x 15 mm	71.1 mm 78.1 mm	83.0 mm 90.5 mm
Weight per piece	93.8 g	95.0 g	177.2 g

Technical Data/Ratings

Approvals						
Wire Size (solid / stranded)	8-2/0 AWG / 10-70 mm ²		8-2/0 AWG / 10-70 mm ²		2-250 KCMIL / 25-120 mm ²	
Voltage Rating	1000 V / 1000 V AC/DC		1000 V / 1000 V AC/DC		1000 V / 1000 V AC/DC	
Current Rating	175 A / 192 A		175 A / 192 A		240 A / 269 A	
Torque	38 lb-in / 3.0 Nm		38 lb-in / 3.0 Nm		90 lb-in / 6.0 Nm	
Insulation Material	Polyamide 66					

Installation Instructions

Wire Stripping Length	22 mm	22 mm	24 mm
Screwdriver	Flat Head 1.0x7.5 mm	Allen Wrench 5 mm	Allen Wrench 6 mm

Terminal Blocks

	Cat. No.	Std. Pk.	Cat. No.	Std. Pk.	Cat. No.	Std. Pk.
Grey (standard)	CTS50/70N	20	CTS50/70NA	20	CTS95/120N	10
Red R	CTS50/70N/R	20	CTS50/70NA/R	20	CTS95/120N/R	10
Blue BU	CTS50/70N/BU	20	CTS50/70NA/BU	20	CTS95/120N/BU	10
Black BL	CTS50/70N/BL	20	CTS50/70NA/BL	20	CTS95/120N/BL	10
Orange O	CTS50/70N/O	20	CTS50/70NA/O	20	CTS95/120N/O	10
Green G	CTS50/70N/G	20	CTS50/70NA/G	20	CTS95/120N/G	10
Yellow Y	CTS50/70N/Y	20	CTS50/70NA/Y	20	CTS95/120N/Y	10
White W	CTS50/70N/W	20	CTS50/70NA/W	20	CTS95/120N/W	10

Accessories

	Cat. No.	Std. Pk.	Cat. No.	Std. Pk.	Cat. No.	Std. Pk.
DIN Rail	2511120 CA701-15/S 2511160	20 20 10	2511120 CA701-15/S 2511160	20 20 10	2511120 CA701-15/S 2511160	20 20 10
End Stop	CA702 CA802 CA202	50 50 25	CA702 CA802 CA202	50 50 25	CA702 CA802 CA202	50 50 25
Shorting Link System	CA628/2 CA628/3	10 10	CA628/2 CA628/3	10 10	CA629/2 CA629/3	10 10
Marking Tag	MT16	1 Pk. (100 tags)	MT16	1 Pk. (100 tags)	MT16	1 Pk. (100 tags)

Cat. No AUX6

Auxiliary Terminal Block

Used for:
CTS50/70N
CTS50/70NA
CTS95/120N

In certain power circuits, there is a need to take an extra connection for an Auxiliary circuit like an indicating light or contactor. The AUX6 terminal easily plugs into the terminal and provides this extra connection point.



Ratings

IEC60947-7-1

Voltage/Current: 1000 V / 41 A
Torque: 0.8 Nm

IEC 60079-7

Voltage/Current: 630 V / 36 A
Torque: 0.8 Nm

UL-1059

Voltage/Current: 600 V / 50 A
Torque: 14 lb-in

CSA22.2-158

Voltage/Current: 600 V / 50 A
Torque: 14 lb-in

Wire Range: 22-8 AWG

Width x Length x Height: 8 x 53.6 x 29.4 mm

Std. Pk.: 10

Marking Tag: MT8

CMC1-2



CMC2-2

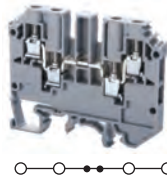

CMCG4

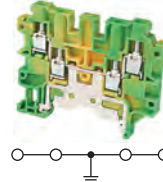

Dimensions & Weight

Width	6 mm		6 mm		6 mm	
Length	46.5 mm		65.0 mm		65.0 mm	
Height w DIN Rail	35 x 7.5 mm 35 x 15 mm	49.5 mm 56.5 mm	53.4 mm 60.5 mm	53.7 mm 60.9 mm	53.7 mm 60.9 mm	
Weight per piece	11.0 g		16.0 g		21.6 g	

Technical Data/Ratings

Approvals						
Wire Size (solid / stranded)	22-10 AWG	0.2-4 mm ²	22-10 AWG	0.2-4 mm ²	24-10 AWG	0.2-4 mm ²
Voltage Rating	600 V	630 V AC/DC	600 V	630 V AC/DC	600 V	1000 V AC/DC
Current Rating	35 A	32 A	35 A	32 A	-	-
Torque	7 lb-in	0.5 Nm	7 lb-in	0.5 Nm	4.5 lb-in	0.5 Nm
Insulation Material	Polyamide 66		Polyamide 66		Polyamide 66	

Installation Instructions

Wire Stripping Length	9 mm		9 mm		9 mm	
Screwdriver	Flat Head 0.6 x 3.5 mm		Flat Head 0.6 x 3.5 mm		Flat Head 0.6 x 3.5 mm	

Terminal Blocks

	Cat. No.	Std. Pk.	Cat. No.	Std. Pk.	Cat. No.	Std. Pk.
Grey (standard)	CMC1-2	100	CMC2-2	50	CMCG4	50
Red R	CMC1-2/R	100	CMC2-2/R	50	Yellow/Green	
Blue BU	CMC1-2/BU	100	CMC2-2/BU	50		
Black BL	CMC1-2/BL	100	CMC2-2/BL	50		
Orange O	CMC1-2/O	100	CMC2-2/O	50		
Green G	CMC1-2/G	100	CMC2-2/G	50		
Yellow Y	CMC1-2/Y	100	CMC2-2/Y	50		
White W	CMC1-2/W	100	CMC2-2/W	50		

Accessories

	Cat. No.	Std. Pk.	Cat. No.	Std. Pk.	Cat. No.	Std. Pk.
End Plate	EPCMC1-2	50	EPCMC2-2	50	EPCMC2-2	50
DIN Rail	2511120	20	2511120	20	2511120	20
	CA701-15/S	20	CA701-15/S	20	CA701-15/S	20
	2511160	10	2511160	10	2511160	10
End Stop	CA702	50	CA702	50	CA702	50
	CA802	50	CA802	50	CA802	50
	CA202	25	CA202	25	CA202	25
Internal Jumper	2 pole CA722/2	100	2 pole CA722/2	100	-	-
	3 pole CA722/3	100	3 pole CA722/3	100	-	-
	4 pole CA722/4	50	4 pole CA722/4	50	-	-
	10 pole CA722/10	10	10 pole CA722/10	10	-	-
	100 pole CA722/100	10	100 pole CA722/100	10	-	-
Insulated Internal Jumper	2 pole CA742/2	100	2 pole CA742/2	100	-	-
	3 pole CA742/3	100	3 pole CA742/3	100	-	-
	4 pole CA742/4	100	4 pole CA742/4	100	-	-
	10 pole CA742/10	10	10 pole CA742/10	10	-	-
	100 pole CA742/100	10	100 pole CA742/100	10	-	-
External Jumper	2 pole CA713/2	100	2 pole CA713/2	100	-	-
	3 pole CA713/3	100	3 pole CA713/3	100	-	-
	4 pole CA713/4	100	4 pole CA713/4	100	-	-
	10 pole CA713/10	20	10 pole CA713/10	20	-	-
Test Socket	CA707/TS/01		CA707/TS/01		-	-
Marking Tag	MT6	1 Pk. (100 tags)	MT6	1 Pk. (100 tags)	MT6	1 Pk. (100 tags)

HIGHLIGHTS

FEATURES

- 3 to 4 connections
- Up to 2 connection points on each side
- 2 jumper channels on **CMC2-2** for individual potential distribution
- **CMCG4** same profile as regular feed-through version

APPLICATIONS

- Connecting different type of wires with different wire sizes into a single terminal block
- Simple distribution applications

HIGHLIGHTS

FEATURES

- Accommodates larger **MT6** marking tags on both levels
- Independent and internally shorted version
- CDL4UN** offers jumper channel on both levels
- Same profile Ground versions
- Grounding Level on **CDLG4** is identified by green/yellow imprint

APPLICATIONS

- High density writing applications

CDL4UN

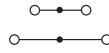

CDL4UN(I.S)

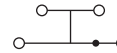

Dimensions & Weight

	CDL4UN	CDL4UN(I.S)
Width	6 mm	6 mm
Length	57.0 mm	57.0 mm
Height w DIN Rail	59.5 mm 67.2 mm	59.5 mm 67.2 mm
Weight per piece	13.8 g	15.6 g

Technical Data/Ratings

Approvals	CDL4UN		CDL4UN(I.S)	
CE, Ex, IEC, Low Voltage Directive, RoHS	UL US E220514	CS US 60947-7-1	UL US E220514	CS US 60947-7-1
Wire Size (solid / stranded)	22-10 AWG	0.2-4 mm ²	22-10 AWG	0.2-4 mm ²
Voltage Rating	600 V	800 V AC/DC	600 V	800 V AC/DC
Current Rating	35 A	32 A	35 A	32 A
Torque	7 lb-in	0.5 Nm	7 lb-in	0.5 Nm
Insulation Material	Polyamide 66		Polyamide 66	

Installation Instructions

Wire Stripping Length	9 mm	9 mm
Screwdriver	Flat Head 0.6 x 3.5 mm	Flat Head 0.6 x 3.5 mm

Terminal Blocks

	Cat. No.	Std. Pk.	Cat. No.	Std. Pk.
Grey (standard)	CDL4UN	100	CDL4UN(I.S)	100
Red R	CDL4UN/R	100	CDL4UN(I.S)/R	100
Blue BU	CDL4UN/BU	100	CDL4UN(I.S)/BU	100
Black BL	CDL4UN/BL	100	CDL4UN(I.S)/BL	100
Orange O	CDL4UN/O	100	CDL4UN(I.S)/O	100
Green G	CDL4UN/G	100	CDL4UN(I.S)/G	100
Yellow Y	CDL4UN/Y	100	CDL4UN(I.S)/Y	100
White W	CDL4UN/W	100	CDL4UN(I.S)/W	100

Accessories

	Cat. No.	Std. Pk.	Cat. No.	Std. Pk.
End Plate	EPCDL4UN	50	EPCDL4UN	50
Separator Plate	SPCDL4U	100	SPCDL4U	100
DIN Rail	2511120 CA701-15/S 2511160	20 20 10	2511120 CA701-15/S 2511160	20 20 10
End Stop	CA702 CA802 CA202	50 50 25	CA702 CA802 CA202	50 50 25
Internal Jumper	2 pole 3 pole 4 pole 10 pole 100 pole	CA722/2 CA722/3 CA722/4 CA722/10 CA722/100	100 100 100 10 10	CA722/2 CA722/3 CA722/4 CA722/10 CA722/100
Insulated Internal Jumper	2 pole 3 pole 4 pole 10 pole 100 pole	CA742/2 CA742/3 CA742/4 CA742/10 CA742/100	100 100 100 10 10	CA742/2 CA742/3 CA742/4 CA742/10 CA742/100
External Jumper	2 pole 3 pole 4 pole 10 pole	CA714/2 CA714/3 CA714/4 CA714/10	100 50 50 20	CA714/2 CA714/3 CA714/4 CA714/10
Test Socket	CA707/TS/01	100	CA707/TS/01	100
Marking Tag	MT6	1 Pk. (100 tags)	MT6	1 Pk. (100 tags)

CDLG4(I.S)

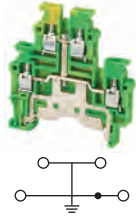

CDLG4

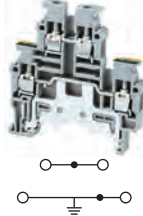

CDLG2.5

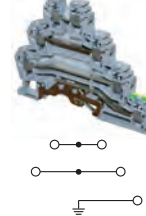

Dimensions & Weight

Width	6 mm	6 mm	6 mm
Length	57.0 mm	57.0 mm	71.0 mm
Height w DIN Rail	35 x 7.5 mm 35 x 15 mm	59.5 mm 67.2 mm	59.5 mm 67.2 mm
Weight per piece	22.2 g	20.6 g	20.2 g

Technical Data/Ratings

Approvals						
Wire Size (solid / stranded)	24-10 AWG	0.2-4 mm ²	24-10 AWG	0.2-4 mm ²	24-12 AWG	0.2-2.5 mm ²
Voltage Rating	150 V	500 V AC/DC	150 V	500 V AC/DC	300 V	500 V
Current Rating	-	-	32 A (upper level)	32 A	24 A	24 A
Torque	4.5 lb-in	0.5 Nm	4.5 lb-in	0.5 Nm	4.5 lb-in	0.4 Nm
Insulation Material	Polyamide 66		Polyamide 66		Polyamide 66	

Installation Instructions

Wire Stripping Length	8 mm	8 mm	9 mm
Screwdriver	Flat Head 0.6 x 3.5 mm	Flat Head 0.6 x 3.5 mm	Flat Head 0.5 x 3.0 mm

Terminal Blocks

Yellow/Green	Cat. No.	Std. Pk.	Cat. No.	Std. Pk.	Cat. No.	Std. Pk.
	CDLG4(I.S)	100	CDLG4	100	CDLG2.5	100

Accessories

End Plate	EPCDL4UN	50	EPCDL4UN	50	EPCDLG2.5	50	
Separator Plate	SPCDL4U	100	SPCDL4U	100	SPCDLG2.5	100	
DIN Rail	2511120 CA701-15/S 2511160	20 20 10	2511120 CA701-15/S 2511160	20 20 10	2511120 CA701-15/S 2511160	20 20 10	
End Stop	CA702 CA802 CA202	50 50 25	CA702 CA802 CA202	50 50 25	CA702 CA802 CA202	50 50 25	
Internal Jumper	2 pole 3 pole 4 pole 10 pole 100 pole	CA722/2 CA722/3 CA722/4 CA722/10 CA722/100	100 100 50 10 10	CA722/2 CA722/3 CA722/4 CA722/10 CA722/100	100 100 50 10 10	CA627/2 CA627/3 CA627/4 CA627/10 -	100 100 100 10 -
Insulated Internal Jumper	2 pole 3 pole 4 pole 10 pole 100 pole	CA742/2 CA742/3 CA742/4 CA742/10 CA742/100	100 100 100 10 10	CA742/2 CA742/3 CA742/4 CA742/10 CA742/100	100 100 100 10 10	- - - - -	- - - - -
External Jumper	2 pole 3 pole 4 pole 10 pole	CA714/2 CA714/3 CA714/4 CA714/10	100 50 50 20	CA714/2 CA714/3 CA714/4 CA714/10	100 50 50 20	CA715/2 CA715/3 CA715/4 CA715/10	100 100 100 20
Test Socket	CA707/TS/01	100	CA707/TS/01	100	CA707/TS/01	100	
Marking Tag	MT6	1 Pk. (100 tags)	MT6	1 Pk. (100 tags)	MT2G	1 Pk. (100 tags)	

DOUBLE LEVEL

SCREW TERMINAL BLOCKS

HIGHLIGHTS

FEATURES

- Top Level is offset by half terminal width from lower level
- Offset allows better access to both levels even when fully wired
- Different Endplates for front and back side guarantee flush mounting to neighboring terminal blocks or end stops
(EPODL4U and EP1ODL4U)

APPLICATIONS

- High density wiring applications

FEED THROUGH OFFSET DOUBLE LEVEL

ODL4U

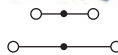

Dimensions & Weight

Width	
Length	
Height w DIN Rail	35 x 7.5 mm 35 x 15 mm
Weight per piece	

6 mm
68 mm
65.0 mm 71.1 mm
14.5 g

Technical Data/Ratings

Approvals		
Wire Size (solid / stranded)	22-10 AWG	
Voltage Rating	600 V	
Current Rating	35 A	32 A
Torque	7 lb-in	0.5 Nm
Insulation Material	Polyamide 66	

 E220514		 60947-7-1
22-10 AWG		0.2-4 mm ²
600 V		800 VAC/DC
35 A	32 A	
7 lb-in	0.5 Nm	
Polyamide 66		

Installation Instructions

Wire Stripping Length	
Screwdriver	

9 mm
Flat Head 0.6 x 3.5 mm

Terminal Blocks

Grey (standard)		
Red	R	
Blue	BU	
Black	BL	
Orange	O	
Green	G	
Yellow	Y	
White	W	

Cat. No.	Std. Pk.
ODL4U	100
ODL4U/R	100
ODL4U/BU	100
ODL4U/BL	100
ODL4U/O	100
ODL4U/G	100
ODL4U/Y	100
ODL4U/W	100

Accessories

End Plate	
Separator Plate	
DIN Rail	
End Stop	
Internal Jumper	2 pole 3 pole 4 pole 10 pole 100 pole
Insulated Internal Jumper	2 pole 3 pole 4 pole 10 pole 100 pole
External Jumper	2 pole 3 pole 4 pole 10 pole
Test Socket	
Marking Tag	

Cat. No.	Std. Pk.
EPODL4U (Front)	50
EP1ODL4U (Back)	50
SPCDL4U	100
2511120	20
CA701-15/S	20
2511160	10
CA702	50
CA802	50
CA202	25
CA727/2	100
CA727/3	100
CA727/4	100
CA727/10	10
CA727/100	10
CA747/2	100
CA747/3	100
CA747/4	100
CA747/10	10
CA747/100	10
CA714/2	100
CA714/3	100
CA714/4	100
CA714/10	20
CA707/TS/01	
MT6	1 Pk. (100 tags)

ODL4U
(without End Plates)



ODL4U
(with End Plates)

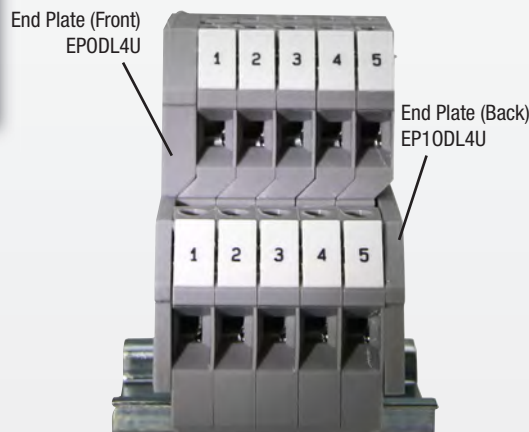

FEED THROUGH DOUBLE LEVEL

ODL2.5

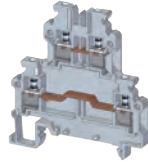

ODL2.5(I.S)

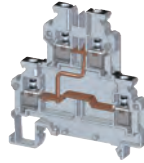

ODLG2.5

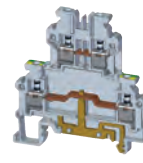

ODLG2.5(I.S)

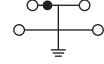

Dimensions & Weight

	ODL2.5	ODL2.5(I.S)	ODLG2.5	ODLG2.5(I.S)
Width	5 mm	5 mm	5 mm	5 mm
Length	62.0 mm	62.0 mm	62.0 mm	62.0 mm
Height w DIN Rail	35 x 7.5 mm 35 x 15 mm	63.0 mm 70.5 mm	63.0 mm 70.5 mm	63.0 mm 70.5 mm
Weight per piece	13.0 g	14.2 g	15.3 g	17.0 g

Technical Data/Ratings

Approvals	UL		IEC		UL		IEC	
	60947-7-1		60947-7-1		60947-7-1		60947-7-1	
Wire Size (solid / stranded)	24-12 AWG	0.2-2.5 mm ²	24-12 AWG	0.2-2.5 mm ²	24-12 AWG	0.2-2.5 mm ²	24-12 AWG	0.2-2.5 mm ²
Voltage Rating	300 V	800 V AC/DC	300 V	800 V AC/DC	300 V	800 V AC/DC	300 V	800 V AC/DC
Current Rating	25 A	24 A	25 A	24 A	25 A	24 A	24 A	24 A
Torque	4.5 lb-in	0.4 Nm	4.5 lb-in	0.4 Nm	4.5 lb-in	0.4 Nm	4.5 lb-in	0.4 Nm
Insulation Material	Polyamide 66		Polyamide 66		Polyamide 66		Polyamide 66	

Installation Instructions

Wire Stripping Length	8 mm	8 mm	8 mm	8 mm
Screwdriver	Flat Head 0.6 x 3.5 mm	Flat Head 0.6 x 3.5 mm	Flat Head 0.6 x 3.5 mm	Flat Head 0.6 x 3.5 mm

Terminal Blocks

	Cat. No.	Std. Pk.	Cat. No.	Std. Pk.	Cat. No.	Std. Pk.	Cat. No.	Std. Pk.
Grey Stackable Clip-on	ODL2.5	50	ODL2.5(I.S)	50	ODLG2.5	50	ODLG2.5(I.S)	50
	ODL2.5A	50	ODL2.5A(I.S)	50	ODLG2.5A	50	ODLG2.5A(I.S)	50

Accessories

	Cat. No.	Std. Pk.	Cat. No.	Std. Pk.	Cat. No.	Std. Pk.	Cat. No.	Std. Pk.
End Plate	EP0DL2.5	50	EP0DL2.5	50	EP0DL2.5	50	EP0DL2.5	50
	EP1ODL2.5	50	EP1ODL2.5	50	EP1ODL2.5	50	EP1ODL2.5	50
DIN Rail	2511120	20	2511120	20	2511120	20	2511120	20
	CA701-15/S	20	CA701-15/S	20	CA701-15/S	20	CA701-15/S	20
End Stop	CA702	50	CA702	50	CA702	50	CA702	50
	CA802	50	CA802	50	CA802	50	CA802	50
	CA202	25	CA202	25	CA202	25	CA202	25
Shorting Link/Jumpers	JX2.5/2	100	JX2.5/2	100	JX2.5/2	100	JX2.5/2	100
	JX2.5/3	50	JX2.5/3	50	JX2.5/3	50	JX2.5/3	50
	JX2.5/4	50	JX2.5/4	50	JX2.5/4	50	JX2.5/4	50
	JX2.5/5	50	JX2.5/5	50	JX2.5/5	50	JX2.5/5	50
	JX2.5/6	10	JX2.5/6	10	JX2.5/6	10	JX2.5/6	10
	JX2.5/7	10	JX2.5/7	10	JX2.5/7	10	JX2.5/7	10
	JX2.5/8	10	JX2.5/8	10	JX2.5/8	10	JX2.5/8	10
	JX2.5/10	10	JX2.5/10	10	JX2.5/10	10	JX2.5/10	10
Marking Tag	MT5	1 Pk. (100 tags)	MT5	1 Pk. (100 tags)	MT5	1 Pk. (100 tags)	MT5	1 Pk. (100 tags)

TRIPLE LEVEL

SCREW TERMINAL BLOCKS

FEED THROUGH TRIPLE LEVEL

HIGHLIGHTS

FEATURES

- 3 Feed through levels
- Marking Tag space on all 3 levels
- Independent Levels and internally shorted version **CTL2.5U(I.S)**
- LED versions to show switching indication in various voltages - **CTL2.5U(L)/XX**
- 3 Level terminal with additional grounding level **CTLG2.5**

APPLICATIONS

- Control Systems with sensor applications
- Actuator applications
- Motor applications
- Applications with high wire density

CTL2.5U

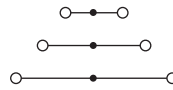

CTL2.5U-H

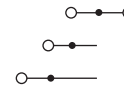

CTL2.5U(I.S)

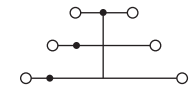
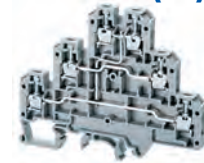

Dimensions & Weight

	CTL2.5U	CTL2.5U-H	CTL2.5U(I.S)
Width	6 mm	6 mm	6 mm
Length	84.0 mm	61.0 mm	84.0 mm
Height w DIN Rail	35 x 7.5 mm 35 x 15 mm	68.0 mm 75.6 mm	68.0 mm 75.6 mm
Weight per piece	20.0 g	21.0 g	21.0 g

Technical Data/Ratings

Approvals						
Wire Size (solid / stranded)	22-12 AWG / 0.2-2.5 mm ²		22-12 AWG / 0.2-2.5 mm ²		22-12 AWG / 0.2-2.5 mm ²	
Voltage Rating	300 V / 500 V AC/DC		300 V / 500 V AC/DC		150 V / 500 V AC/DC	
Current Rating	25 A / 24 A		25 A / 24 A		25 A / 24 A	
Torque	4.5 lb-in / 0.4 Nm		4.5 lb-in / 0.4 Nm		4.5 lb-in / 0.4 Nm	
Insulation Material	Polyamide 66					

Installation Instructions

	CTL2.5U	CTL2.5U-H	CTL2.5U(I.S)
Wire Stripping Length	9 mm	9 mm	9 mm
Screwdriver	Flat Head 0.5 x 3.0 mm	Flat Head 0.5 x 3.0 mm	Flat Head 0.5 x 3.0 mm

Terminal Blocks

	Cat. No.	Std. Pk.	Cat. No.	Std. Pk.	Cat. No.	Std. Pk.
Grey (standard)	CTL2.5U	50	CTL2.5U-H	50	CTL2.5U(I.S)	50
Red R	CTL2.5U/R	50	CTL2.5U-H/R	50	CTL2.5U(I.S)/R	50
Blue BU	CTL2.5U/BU	50	CTL2.5U-H/BU	50	CTL2.5U(I.S)/BU	50
Black BL	CTL2.5U/BL	50	CTL2.5U-H/BL	50	CTL2.5U(I.S)/BL	50
Orange O	CTL2.5U/O	50	CTL2.5U-H/O	50	CTL2.5U(I.S)/O	50
Green G	CTL2.5U/G	50	CTL2.5U-H/G	50	CTL2.5U(I.S)/G	50
Yellow Y	CTL2.5U/Y	50	CTL2.5U-H/Y	50	CTL2.5U(I.S)/Y	50
White W	CTL2.5U/W	50	CTL2.5U-H/W	50	CTL2.5U(I.S)/W	50

Accessories

	Cat. No.	Std. Pk.	Cat. No.	Std. Pk.	Cat. No.	Std. Pk.
End Plate	EPCTL2.5U	50	EPCTL2.5U-H	50	EPCTL2.5U	50
DIN Rail	2511120	20	2511120	20	2511120	20
	CA701-15/S	20	CA701-15/S	20	CA701-15/S	20
	2511160	10	2511160	10	2511160	10
End Stop	CA702	50	CA702	50	CA702	50
	CA802	50	CA802	50	CA802	50
	CA202	25	CA202	25	CA202	25
Internal Jumper	CA722/2	100	CA722/2	100	CA722/2	100
	CA722/3	100	CA722/3	100	CA722/3	100
	CA722/4	100	CA722/4	100	CA722/4	100
	CA722/10	10	CA722/10	10	CA722/10	10
	CA722/100	10	CA722/100	10	CA722/100	10
External Jumper	CA715/2	100	CA715/2	100	CA715/2	100
	CA715/3	100	CA715/3	100	CA715/3	100
	CA715/4	100	CA715/4	100	CA715/4	100
	CA715/10	20	CA715/10	20	CA715/10	20
Test Socket	CA707/TS/01	100	CA707/TS/01	100	CA707/TS/01	100
Marking Tag	MT2	1 Pk. (100 tags)	MT2	1 Pk. (100 tags)	MT2	1 Pk. (100 tags)

CTL2.5U-H(L)/XX

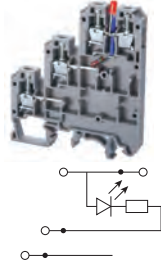

CTL2.5U(L)/XX

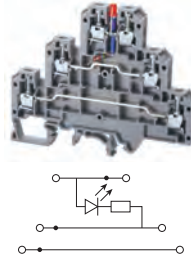

CTL2.5UH(I.S)D2



CTLG2.5

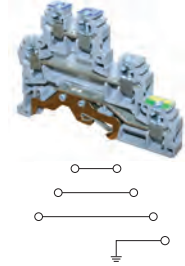

Dimensions & Weight

Width	6 mm		6 mm		6 mm		6 mm	
Length	61.0 mm		84.0 mm		61.0 mm		87.5 mm	
Height w/ DIN Rail	35 x 7.5 mm 35 x 15 mm	68.0 mm 75.6 mm	68.0 mm 75.6 mm	68.0 mm 75.6 mm	68.0 mm 75.6 mm	66.0 mm 74.0 mm	66.0 mm 74.0 mm	27.4 g
Weight per piece	21.0 g		21.0 g		15.1 g		27.4 g	

Technical Data/Ratings

Approvals 								
Wire Size (solid / stranded)	22-12 AWG	0.2-2.5 mm ²	22-12 AWG	0.2-2.5 mm ²	22-12 AWG	0.2-2.5 mm ²	24-12 AWG	0.2-2.5 mm ²
Voltage Rating	300 V	500 V AC/DC	300 V	500 V AC/DC	150 V	500 V AC/DC	300 V	440 V
Current Rating	25 A	24 A	25 A	24 A	25 A	24 A	24 A	24 A
Torque	4.5 lb-in	0.4 Nm	4.5 lb-in	0.4 Nm	4.5 lb-in	0.4 Nm	4.5 lb-in	0.4 Nm
Insulation Material	Polyamide 66		Polyamide 66		Polyamide 66		Polyamide 66	

Installation Instructions

Wire Stripping Length	9 mm		9 mm		9 mm		9 mm	
Screwdriver	Flat Head 0.5 x 3.0 mm		Flat Head 0.5 x 3.0 mm		Flat Head 0.5 x 3.0 mm		Flat Head 0.6 x 3.5 mm	

Terminal Blocks

	Cat. No.	Std. Pk.	Cat. No.	Std. Pk.	Cat. No.	Std. Pk.	Cat. No.	Std. Pk.
Grey					CTL2.5UH(I.S)D2	50	CTLG2.5	100
LED Voltage 12 V	CTL2.5U-H(L)/12	50	CTL2.5U(L)/12	50			Yellow/Green	
LED Voltage 24 V	CTL2.5U-H(L)/24	50	CTL2.5U(L)/24	50				
LED Voltage 48 V	CTL2.5U-H(L)/48	50	CTL2.5U(L)/48	50				
LED Voltage 110 V	CTL2.5U-H(L)/110	50	CTL2.5U(L)/110	50				
LED Voltage 220 V	CTL2.5U-H(L)/220	50	CTL2.5U(L)/220	50				

Accessories

	Cat. No.	Std. Pk.	Cat. No.	Std. Pk.	Cat. No.	Std. Pk.	Cat. No.	Std. Pk.	
End Plate	EPCTL2.5U-H	50	EPCTL2.5U	50	EPCTL2.5U-H	50	EPCTLG2.5	50	
DIN Rail	2511120 CA701-15/S 2511160	20 20 10	2511120 CA701-15/S 2511160	20 20 10	2511120 CA701-15/S 2511160	20 20 10	2511120 CA701-15/S 2511160	20 20 10	
End Stop	CA702 CA802 CA202	50 50 25	CA702 CA802 CA202	50 50 25	CA702 CA802 CA202	50 50 25	CA702 CA802 CA202	50 50 25	
Internal Jumper	2 pole 3 pole 4 pole 10 pole 100 pole	CA722/2 CA722/3 CA722/4 CA722/10 CA722/100	100 100 100 10 10	CA722/2 CA722/3 CA722/4 CA722/10 CA722/100	100 100 100 10 10	CA722/2 CA722/3 CA722/4 CA722/10 CA722/100	100 100 100 10 10	CA627/2 CA627/3 CA627/4 CA627/10 -	100 100 100 10 -
External Jumper	2 pole 3 pole 4 pole 10 pole	CA715/2 CA715/3 CA715/4 CA715/10	100 100 100 20	CA715/2 CA715/3 CA715/4 CA715/10	100 100 100 20	CA715/2 CA715/3 CA715/4 CA715/10	100 100 100 20	CA715/2 CA715/3 CA715/4 CA715/10	100 100 100 20
Test Socket	CA707/TS/01	100	CA707/TS/01	100	CA707/TS/01	100	CA707/TS/01	100	
Marking Tag	MT2	1 Pk. (100 tags)	MT2	1 Pk. (100 tags)	MT2	1 Pk. (100 tags)	MT2G	1 Pk. (100 tags)	

HIGHLIGHTS

FEATURES

- Yellow/Green color code as per industry standard
- Clamp mechanically on Rail by tightening middle screw
- Rail serves as grounding busbar to feed ground potential to all other grounding terminals
- **CGT4N, CGT6N, CGT10N and CGT16N** have same profile as respective feed through blocks
- **CGT4U, CGT10U, and CGT35U** mount on both 35mm and 32mm DIN-Rail

APPLICATIONS

- Grounding Applications



Dimensions & Weight

	CGT4U	CGT4N	CGT6N
Width	6 mm	6 mm	8 mm
Length	43 mm	54.2 mm	54.5 mm
Height w DIN Rail	35 x 7.5 mm 35 x 15 mm	49.5 mm 56.7 mm	48.2 mm 55.8 mm
Weight per piece	21.5 g	22.0 g	27.0 g

Technical Data/Ratings

Approvals						
Wire Size (solid / stranded)	22-10 AWG / 0.2-4 mm ²		22-10 AWG / 0.2-4 mm ²		22-8 AWG / 0.2-6 mm ²	
Voltage Rating	600V / 800 VAC/DC		600V / 1000 VAC/DC		600V / 1000 VAC/DC	
Current Rating	-		-		-	
Torque	7.0 lb-in / 0.5 Nm		7 lb-in / 0.5 Nm		14 lb-in / 1.6 Nm	
Insulation Material	Polyamide 66		Polyamide 66		Polyamide 66	

Installation Instructions

	CGT4U	CGT4N	CGT6N
Wire Stripping Length	8 mm	8 mm	9 mm
Screwdriver	Flat Head 0.6 x 3.5 mm	Flat Head 0.6 x 3.5 mm	Flat Head 0.8 x 4.0 mm

Terminal Blocks

	Cat. No.	Std. Pk.	Cat. No.	Std. Pk.	Cat. No.	Std. Pk.
Yellow/Green	CGT4U	50	CGT4N	50	CGT6N	50

Accessories

	Cat. No.	Std. Pk.	Cat. No.	Std. Pk.	Cat. No.	Std. Pk.
End Plate	EPCGT4U/Y	50	-	-	-	-
DIN Rail	2511120 CA701-15/S 2511160	20 20 10	2511120 CA701-15/S 2511160	20 20 10	2511120 CA701-15/S 2511160	20 20 10
Marking Tag	MT6	1 Pk. (100 tags)	MT6	1 Pk. (100 tags)	MT8	1 Pk. (100 tags)

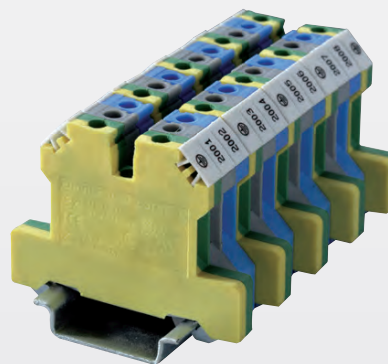

Assembly example for single phase 3 wire circuits.

GROUND/EARTH TERMINAL BLOCKS

CGT10U



CGT10N

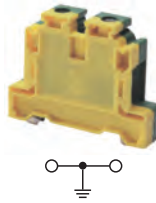

CGT16N



CGT35U

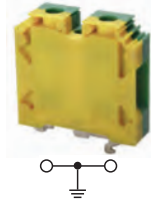

Dimensions & Weight

Width	10 mm	10 mm	12 mm	16 mm
Length	45.0 mm	55.0 mm	55.0 mm	58.0 mm
Height w DIN Rail	35 x 7.5 mm 35 x 15 mm	51.0 mm 58.2 mm	48.5 mm 56.0 mm	63.7 mm 70.5 mm
Weight per piece	30.5 g	35.2 g	39.6 g	102.0 g

Technical Data/Ratings

Approvals 	 E220514	 US	 60947-7-1	 E220514	 US	 60947-7-1	 E220514	 US	 60947-7-1	 E220514	 US	 IEC
Wire Size (solid / stranded)	16-8 AWG	22-6 AWG	0.2-10 mm ²	16-6 AWG	0.2-10 mm ²	20-4 AWG	0.2-16 mm ²	8-2 AWG	2.5-35 mm ²			
Voltage Rating	600 V	600 V	1000 VAC/DC	600 V	1000 VAC/DC	600 V	1000 VAC/DC	600 V	1000 VAC/DC			
Current Rating	-			-			-					
Torque	14 lb-in	14 lb-in	1.6 Nm	14 lb-in	1.6 Nm	14 lb-in	1.6 Nm	25 lb-in	2.8 Nm			
Insulation Material	Polyamide 66			Polyamide 66			Polyamide 66					

Installation Instructions

Wire Stripping Length	11 mm	11 mm	12 mm	15 mm
Screwdriver	Flat Head 0.8 x 4.0 mm	Flat Head 0.8 x 4.0 mm	Flat Head 1.0 x 5.5 mm	Flat Head 1.0 x 5.5 mm

Terminal Blocks

	Cat. No.	Std. Pk.	Cat. No.	Std. Pk.	Cat. No.	Std. Pk.	Cat. No.	Std. Pk.
Yellow/Green	CGT10U	50	CGT10N	50	CGT16N	50	CGT35U	20

Accessories

End Plate	-	-	-	-	-	-	-	-
DIN Rail	2511120	20	2511120	20	2511120	20	2511120	20
	CA701-15/S	20	CA701-15/S	20	CA701-15/S	20	CA701-15/S	20
	2511160	10	2511160	10	2511160	10	2511160	10
Marking Tag	MT10	1 Pk. (100 tags)	MT10	1 Pk. (100 tags)	MT12	1 Pk. (100 tags)	MT16	1 Pk. (100 tags)

FUSE BLOCKS

SCREW TERMINAL BLOCKS

FUSE BLOCKS, 5 x 20 and 5 x 25 mm

HIGHLIGHTS

FEATURES

- CF4U Series accepts 5x20mm/ 5x25mm fuse types
- Completely enclosed, no endplates
- CF4U(L) version with LED for blown fuse indication
- Large marking area
- No polarity required
- Blocks can be used for AC & DC Voltages

APPLICATIONS

- Control systems with fuse protection

CF4U

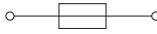

CF4U(L)/6-60V

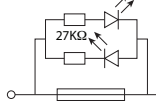
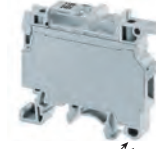

CF4U(L)/110-240V

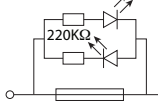

Dimensions & Weight

Width	8 mm	8 mm	8 mm
Length	57.0 mm	57.0 mm	57.0 mm
Height w DIN Rail	35 x 7.5 mm 35 x 15 mm	50.3 mm 57.6 mm	50.3 mm 57.6 mm
Weight per piece	14.8 g	15.4 g	15.4 g

Technical Data/Ratings

Approvals						
Wire Size (solid / stranded)	22-10 AWG		0.2-4 mm ²		22-10 AWG	
Voltage Rating	600 V		800 V AC/DC		600 V	
Current Rating	10 A		6.3 A		10 A	
Torque	7 lb-in		0.5 Nm		7 lb-in	
Insulation Material	Polyamide 66					

Fuse Specifications

Fuse Type	5x20 mm / 5 x 25 mm	5x20 mm / 5 x 25 mm	5x20 mm / 5 x 25 mm
LED Indicator Voltage	-	6-60V AC/DC	110-240V AC/DC

Installation Instructions

Wire Stripping Length	9.5 mm	9.5 mm	9.5 mm
Screwdriver	Flat Head 0.6 x 3.5 mm	Flat Head 0.6 x 3.5 mm	Flat Head 0.6 x 3.5 mm

Terminal Blocks

	Cat. No.	Std. Pk.	Cat. No.	Std. Pk.	Cat. No.	Std. Pk.
Grey (standard)	CF4U	50	CF4U(L)/6-60V	50	CF4U(L)/110-240V	50
Blue BU	CF4U/BU	50	CF4U(L)/6-60V/BU	50	CF4U(L)/110-240V/BU	50
Black BL	CF4U/BL	50	CF4U(L)/6-60V/BL	50	CF4U(L)/110-240V/BL	50

Accessories

	Cat. No.	Std. Pk.	Cat. No.	Std. Pk.	Cat. No.	Std. Pk.
DIN Rail	2511120	20	2511120	20	2511120	20
	CA701-15/S	20	CA701-15/S	20	CA701-15/S	20
	2511160	10	2511160	10	2511160	10
External Jumper	CA711/2	100	CA711/2	100	CA711/2	100
	CA711/3	50	CA711/3	50	CA711/3	50
	CA711/4	50	CA711/4	50	CA711/4	50
	CA711/10	20	CA711/10	20	CA711/10	20
Marking Tag	MT8	1 Pk. (100 tags)	MT8	1 Pk. (100 tags)	MT8	1 Pk. (100 tags)
On Terminal	MT6	1 Pk. (100 tags)	MT6	1 Pk. (100 tags)	MT6	1 Pk. (100 tags)
On Fuse Carrier						

Fuses 5 x 20 mm



Current Rating	Slow Blow Cat. No	Fast Blow Cat. No
0.1A	0.1M5x20T	0.1M5x20F
0.2A	0.2M5x20T	0.2M5x20F
0.5A	0.5M5x20T	0.5M5x20F
1.0A	1.0M5x20T	1.0M5x20F
2.0A	2.0M5x20T	2.0M5x20F
4.0A	4.0M5x20T	4.0M5x20F
5.0A	5.0M5x20T	5.0M5x20F
6.3A	6.3M5x20T	6.3M5x20F
8.0A	8.0M5x20T	8.0M5x20F
10.0A	10.0M5x20T	10.0M5x20F

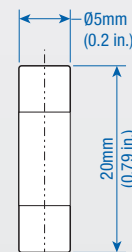

FUSE BLOCKS, 5 x 20 and 5 x 25 mm

CF4SP

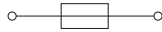

CF4SP(L)/6-60V

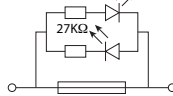

CF4SP(L)/110-240V

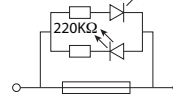

Dimensions & Weight

Width	6 mm	6 mm	6 mm
Length	58.5 mm	58.5 mm	58.5 mm
Height w/ DIN Rail	35 x 7.5 mm 35 x 15 mm	70.0 mm 77.5 mm	70.0 mm 77.5 mm
Weight per piece	16.9 g	17.4 g	17.4 g

Technical Data/Ratings

Approvals						
Wire Size (solid / stranded)	24-10 AWG		0.2-4 mm ²		24-10 AWG	
Voltage Rating	600 V		1000 V AC/DC		600 V	
Current Rating	10 A		10 A		10 A	
Torque	4.5 lb-in		0.5 Nm		4.5 lb-in	
Insulation Material	Polyamide 66					

Fuse Specifications

Fuse Type	5x20 mm / 5 x 25 mm	5x20 mm / 5 x 25 mm	5x20 mm / 5 x 25 mm
LED Indicator Voltage	-	6-60V AC/DC	110-240V AC/DC

Installation Instructions

Wire Stripping Length	8 mm	8 mm	8 mm
Screwdriver	Flat Head 0.6 x 3.5 mm	Flat Head 0.6 x 3.5 mm	Flat Head 0.6 x 3.5 mm

Terminal Blocks

	Cat. No.	Std. Pk.	Cat. No.	Std. Pk.	Cat. No.	Std. Pk.
Grey (standard)	CF4SP	50	CF4SP(L)/6-60V	50	CF4SP(L)/110-240V	50
Blue BU	CF4SP/BU	50	CF4SP(L)/6-60V/BU	50	CF4SP(L)/110-240V/BU50	
Black BL	CF4SP/BL	50	CF4SP(L)/6-60V/BL	50	CF4SP(L)/110-240V/BL50	

Accessories

	Cat. No.	Std. Pk.	Cat. No.	Std. Pk.	Cat. No.	Std. Pk.	
DIN Rail 	2511120	20	2511120	20	2511120	20	
	CA701-15/S	20	CA701-15/S	20	CA701-15/S	20	
	2511160	10	2511160	10	2511160	10	
Internal Jumper 	CA722/2	100	CA722/2	100	CA722/2	100	
	CA722/3	100	CA722/3	100	CA722/3	100	
	CA722/4	100	CA722/4	100	CA722/4	100	
	CA722/10	10	CA722/10	10	CA722/10	10	
	CA722/100	10	CA722/100	10	CA722/100	10	
Insulated Internal Jumper 	CA742/2	100	CA742/2	100	CA742/2	100	
	CA742/3	100	CA742/3	100	CA742/3	100	
	CA742/4	100	CA742/4	100	CA742/4	100	
	CA742/10	10	CA742/10	10	CA742/10	10	
	CA742/100	10	CA742/100	10	CA742/100	10	
External Jumper 	CA714/2	100	CA714/2	100	CA714/2	100	
	CA714/3	100	CA714/3	100	CA714/3	100	
	CA714/4	100	CA714/4	100	CA714/4	100	
	CA714/10	20	CA714/10	20	CA714/10	20	
Marking Tag 	On Terminal	MT6	1 Pk. (100 tags)	MT6	1 Pk. (100 tags)	MT6	1 Pk. (100 tags)
	On Fuse Carrier	MT6	1 Pk. (100 tags)	MT6	1 Pk. (100 tags)	MT6	1 Pk. (100 tags)

HIGHLIGHTS

FEATURES

- CF4SP Series accepts 5x20mm fuse types
- 6mm wide, compact design
- Internal shorting channel
- Completely enclosed, no endplates
- CF4SP(L) version with LED for blown fuse indication
- No polarity required

APPLICATIONS

- Control systems with fuse protection
- Control Circuits with alternating configuration with (CF4SPFT, CKT4SP, etc...)

CF4SPFT

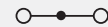
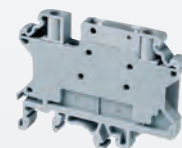

Feed Through Terminal
Same Profile as CF4SP

Technical Data/Ratings

Approvals		
Wire Size (solid / stranded)	24-10 AWG	0.2-4 mm ²
Voltage Rating	600 V	1000 V
Current Rating	30 A	32 A
Torque	4.5 lb-in	0.5 Nm
Insulation Material	Polyamide 66	

FUSE BLOCKS

SCREW TERMINAL BLOCKS

DOUBLE LEVEL FUSE BLOCKS, 5 x 20 / 5 x 25 mm

HIGHLIGHTS

FEATURES

- Top Level fuse link for 5x20mm/ 5x25mm fuse types
- Bottom Level Feed through terminal
- **DDFL4U(E)** version with LED for blown fuse indication in various voltages
- Blocks can be used in AC & DC applications

APPLICATIONS

- Tight space fuse applications
- No need for additional Feed through terminal

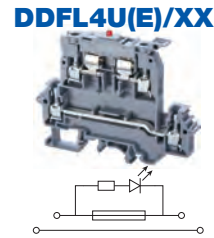

Dimensions & Weight

Width	8 mm	
Length	88 mm	
Height w DIN Rail	35 x 7.5 mm 35 x 15 mm	67.4 mm 74.3 mm
Weight per piece	28.0 g	

Technical Data/Ratings

Approvals				
Wire Size (solid / stranded)	22-10 AWG		0.2-4 mm ²	
Voltage Rating	600 V		800 V AC/DC	
Current Rating (top)	6.3 A		6.3 A	
Current Rating (bottom)	35 A		32 A	
Torque	7 lb-in		0.5 Nm	
Insulation Material	Polyamide 66			

Fuse Specifications

Fuse Type	5x20 mm / 5 x 25 mm	5x20 mm / 5 x 25 mm
LED Indicator Voltage	-	24V, 48V, 110V, 220V, 440V

Installation Instructions

Wire Stripping Length	9.5 mm	9.5 mm
Screwdriver	Flat Head 0.6 x 3.5 mm	Flat Head 0.6 x 3.5 mm

Terminal Blocks

	Cat. No.	Std. Pk.	Cat. No.	Std. Pk.
Grey	DDFL4U	20	DDFL4U(E)/24	20
LED Voltage 24V AC/DC			DDFL4U(E)/48	20
LED Voltage 48V AC/DC			DDFL4U(E)/110	20
LED Voltage 110V AC/DC			DDFL4U(E)/220	20
LED Voltage 220V AC/DC			DDFL4U(E)/440	20
LED Voltage 440V AC				

Accessories

	Cat. No.	Std. Pk.	Cat. No.	Std. Pk.
End Plate	EPDDL4U	50	EPDDL4U	50
DIN Rail	2511120 CA701-15/S 2511160	20 20 10	2511120 CA701-15/S 2511160	20 20 10
End Stop	CA702 CA802 CA202	50 50 25	CA702 CA802 CA202	50 50 25
Internal Jumper	CA729/2 CA729/3 CA729/4 CA729/10	100 50 50 10	CA729/2 CA729/3 CA729/4 CA729/10	100 50 50 10
Insulated Internal Jumper	CA749/2 CA749/3 CA749/4 CA749/10	100 50 50 10	CA749/2 CA749/3 CA749/4 CA749/10	100 50 50 10
External Jumper	CA711/2 CA711/3 CA711/4 CA711/10	100 50 50 20	CA711/2 CA711/3 CA711/4 CA711/10	100 50 50 20
Marking Tag	MT8 MT2	1 Pk. (100 tags) 1 Pk. (100 tags)	MT8 MT2	1 Pk. (100 tags) 1 Pk. (100 tags)

DOUBLE LEVEL FUSE BLOCKS, 5 x 20 / 5 x 25 mm WITH 2 CONNECTION POINTS

DDFL4ULR



DDFL4U(E)LR/XX

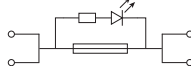

Dimensions & Weight

Width	8 mm	
Length	88 mm	
Height w DIN Rail	35 x 7.5 mm 35 x 15 mm	67.4 mm 74.3 mm
Weight per piece	24.5 g	

Technical Data/Ratings

Approvals				
Wire Size (solid / stranded)	22-10 AWG	0.2-4 mm ²	22-10 AWG	0.2-4 mm ²
Voltage Rating	600 V	800 V AC/DC	600 V	800 V AC/DC
Current Rating (top)	6.3 A	6.3 A	6.3 A	6.3 A
Torque	7 lb-in	0.5 Nm	7 lb-in	0.5 Nm
Insulation Material	Polyamide 66		Polyamide 66	

Fuse Specifications

Fuse Type	5x20 mm / 5 x 25 mm	5x20 mm / 5 x 25 mm
LED Indicator Voltage	-	24V, 48V, 110V, 220V, 440V

Installation Instructions

Wire Stripping Length	9.5 mm	9.5 mm
Screwdriver	Flat Head 0.6 x 3.5 mm	Flat Head 0.6 x 3.5 mm

Terminal Blocks

	Cat. No.	Std. Pk.	Cat. No.	Std. Pk.
Grey LED Voltage 24V AC/DC LED Voltage 48V AC/DC LED Voltage 110V AC/DC LED Voltage 220V AC/DC LED Voltage 440V AC	DDFL4ULR	20	DDFL4U(E)LR/24	20
			DDFL4U(E)LR/48	20
			DDFL4U(E)LR/110	20
			DDFL4U(E)LR/220	20
			DDFL4U(E)LR/440	20

Accessories

	Cat. No.	Std. Pk.	Cat. No.	Std. Pk.
End Plate	EPDDL4U	50	EPDDL4U	50
DIN Rail	2511120	20	2511120	20
	CA701-15/S	20	CA701-15/S	20
	2511160	10	2511160	10
End Stop	CA702	50	CA702	50
	CA802	50	CA802	50
	CA202	25	CA202	25
Internal Jumper	2 pole CA729/2	100	2 pole CA729/2	100
	3 pole CA729/3	50	3 pole CA729/3	50
	4 pole CA729/4	50	4 pole CA729/4	50
	10 pole CA729/10	10	10 pole CA729/10	10
Insulated Internal Jumper	2 pole CA749/2	100	2 pole CA749/2	100
	3 pole CA749/3	50	3 pole CA749/3	50
	4 pole CA749/4	50	4 pole CA749/4	50
	10 pole CA749/10	10	10 pole CA749/10	10
External Jumper	2 pole CA711/2	100	2 pole CA711/2	100
	3 pole CA711/3	50	3 pole CA711/3	50
	4 pole CA711/4	50	4 pole CA711/4	50
	10 pole CA711/10	20	10 pole CA711/10	20
Marking Tag	MT8	1 Pk. (100 tags)	MT8	1 Pk. (100 tags)
	MT2	1 Pk. (100 tags)	MT2	1 Pk. (100 tags)

HIGHLIGHTS

FEATURES

- Modified version of **DDFL4U** with 2 equipotential
- **DDFL4U(E)** version with LED for blown fuse indication in various voltages
- Blocks can be used in AC & DC applications

APPLICATIONS

- Control Circuits with multi wire fuse application

FUSE BLOCKS

SCREW TERMINAL BLOCKS

FUSE BLOCKS, 1/4 x 1 and 1/4 x 1 1/4 in.

HIGHLIGHTS

FEATURES

- **CAFL4U** Series accepts 1/4" x 1-1/4" (6.3x32mm) fuse types
- **CAFL4U(L)** versions with LED for blown fuse indication (24V, 48V, 110V, 220V)
- **CAFL4U(N)** version with Neon bulb for blown fuse indication
- Large marking area
- Blocks can be used in AC & DC applications

APPLICATIONS

- Control systems with 1/4" x 1-1/4" fuse protection

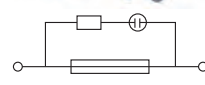
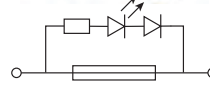
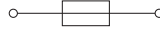

Dimensions & Weight

	CAFL4U	CAFL4U(L)/XX	CAFL4U(N)
Width	9 mm	9 mm	9 mm
Length	72 mm	72 mm	72 mm
Height w/ DIN Rail	35 x 7.5 mm 35 x 15 mm	55.3 mm 63.0 mm	55.3 mm 63.0 mm
Weight per piece	20.5 g	20.5 g	20.5 g

Technical Data/Ratings

Approvals	CAFL4U		CAFL4U(L)/XX		CAFL4U(N)	
	UL E220514	IEC 60947-7-3	UL E220514	IEC 60947-7-3	UL E220514	IEC 60947-7-3
Wire Size (solid / stranded)	22-10 AWG	0.2-4 mm ²	22-10 AWG	0.2-4 mm ²	22-10 AWG	0.2-4 mm ²
Voltage Rating	600 V	1000 V	600 V	1000 V	600 V	1000 V
Current Rating	16 A	6.3 A	16 A	6.3 A	16 A	6.3 A
Torque	7 lb-in	0.5 Nm	7 lb-in	0.5 Nm	7 lb-in	0.5 Nm
Insulation Material	Polyamide 66		Polyamide 66		Polyamide 66	

Installation Instructions

	CAFL4U	CAFL4U(L)/XX	CAFL4U(N)
Wire Stripping Length	9.5 mm	9.5 mm	9.5 mm
Screwdriver	Flat Head 0.6 x 3.5 mm	Flat Head 0.6 x 3.5 mm	Flat Head 0.6 x 3.5 mm

Fuse Specifications

	CAFL4U	CAFL4U(L)/XX	CAFL4U(N)
Fuse Type	1/4" x 1" (6.3 x 32 mm)	1/4" x 1" (6.3 x 32 mm)	1/4" x 1" (6.3 x 32 mm)
LED/Neon Indicator Voltage	-	24V, 48V, 110V, 220V	110V - 240V

Terminal Blocks

	Cat. No.	Std. Pk.	Cat. No.	Std. Pk.	Cat. No.	Std. Pk.
Grey (standard)	CAFL4U	25	-	-	-	-
Blue BU	CAFL4U/BU	25	-	-	-	-
Black BL	CAFL4U/BL	25	-	-	-	-
LED Voltage 24V AC/DC	-	-	CAFL4U(L)/24	25	-	-
LED Voltage 48V AC/DC	-	-	CAFL4U(L)/48	25	-	-
LED Voltage 110V AC/DC	-	-	CAFL4U(L)/110	25	-	-
LED Voltage 220V AC/DC	-	-	CAFL4U(L)/220	25	-	-
Neon Bulb 110-300V AC/DC	-	-	-	-	CAFL4U(N)	25

Accessories

	Cat. No.	Std. Pk.	Cat. No.	Std. Pk.	Cat. No.	Std. Pk.
End Plate	EPCAF4U	50	EPCAF4U	50	EPCAF4U	50
DIN Rail	2511120	20	2511120	20	2511120	20
	CA701-15/S	20	CA701-15/S	20	CA701-15/S	20
	2511160	10	2511160	10	2511160	10
End Stop	CA702	50	CA702	50	CA702	50
	CA802	50	CA802	50	CA802	50
	CA202	25	CA202	25	CA202	25
External Jumper	CA716/2	50	CA716/2	50	CA716/2	50
	CA716/3	50	CA716/3	50	CA716/3	50
	CA716/4	50	CA716/4	50	CA716/4	50
	CA716/10	20	CA716/10	20	CA716/10	20
Marking Tag	MT9	1 Pk. (100 tags)	MT9	1 Pk. (100 tags)	MT9	1 Pk. (100 tags)

Fuses
1/4" x 1-1/4"
(6.3 x 32mm)



Current Rating	Slow Blow Cat. No	Fast Blow Cat. No	Current Rating	Slow Blow Cat. No	Fast Blow Cat. No
0.1A	0.1M6.3x32T	0.1M6x32F	4.0A	4.0M6.3x32T	4.0M6x32F
0.2A	0.2M6.3x32T	0.2M6x32F	5.0A	5.0M6.3x32T	5.0M6x32F
0.5A	0.5M6.3x32T	0.5M6x32F	6.3A	6.3M6.3x32T	6.3M6x32F
1.0A	1.0M6.3x32T	1.0M6x32F	8.0A	8.0M6.3x32T	8.0M6x32F
2.0A	2.0M6.3x32T	2.0M6x32F	10.0A	10.0M6.3x32T	10.0M6x32F

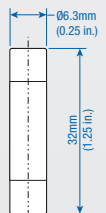

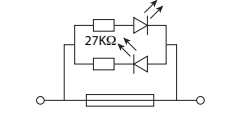
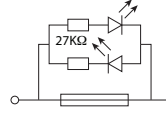
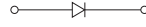

Dimensions

Width	6 mm	6 mm	6 mm	6 mm
Length	58.5 mm	28 mm	28 mm	28 mm
Height w DIN Rail	35 x 7.5 mm 35 x 15 mm	46 mm 53.5 mm	35 mm	35 mm
Weight per piece	10.2 g	3.8 g	3.8 g	4.2 g

Technical Data/Ratings

Approvals							
Wire Size (solid stranded)	0.2-6 mm ² 0.2-4 mm ²	24-10 AWG 0.2-4 mm ²	0.2-4 mm ²	24-10 AWG 0.2-4 mm ²	0.2-4 mm ²	24-10 AWG 0.2-4 mm ²	0.2-4 mm ²
Voltage Rating	1000 V AC/DC	600 V 1000V AC/DC	1000V AC/DC	600 V 1000V AC/DC	1000V AC/DC	600 V 1000V AC/DC	1000V AC/DC
Current Rating	*	1 A 1 A	1 A	10 A 10 A	10 A	10 A 10 A	10 A
Insulation Material	Polyamide 66	Polyamide 66	Polyamide 66	Polyamide 66	Polyamide 66	Polyamide 66	Polyamide 66

Carrier Specifications

Component Type	Component carrier base	Plug module with diode Diode Type IN4007	Plug module for 5x20 mm fuse	Plug module for 5x20 mm fuse with LED indicator
LED Indicator Voltage	-	-	-	6-60V AC/DC 110-240V AC/DC

Installation Instructions

Wire Stripping Length	8 mm	10 mm	10 mm	10 mm
Screwdriver	Flat Head 0.6 x 3.5 mm	Flat Head 0.6 x 3.5 mm	Flat Head 0.6 x 3.5 mm	Flat Head 0.6 x 3.5 mm

Terminal Blocks

	Cat. No.	Std. Pk.	Cat. No.	Std. Pk.	Cat. No.	Std. Pk.	Cat. No.	Std. Pk.
Grey (standard)	CCC4U	50	CPF	50	CPFL6-60V	50	CPFL110-240V	50

Accessories

	Cat. No.	Std. Pk.	Cat. No.	Std. Pk.	Cat. No.	Std. Pk.	Cat. No.	Std. Pk.
DIN Rail	2511120 CA701-15/S	20 10	-	-	-	-	-	-
End Stop	CA702 CA802 CA103	50 50 50	-	-	-	-	-	-
Internal Jumpers	2 pole 3 pole 4 pole 10 pole 100 pole	CA722/2 CA722/3 CA722/4 CA722/10 CA722/100	100 100 100 10 10	-	-	-	-	-
Marking Tag	MT6	1 Pk. (100 tags)	MT6	1 Pk. (100 tags)	MT6	1 Pk. (100 tags)	MT6	1 Pk. (100 tags)

* Current Rating is based on plug used.

10x38 Midget Fuse Holders



Pole Configuration	Without Indication	With LED Indication	Fuse Size	Max Voltage & Current		Drawing No.
				IEC	UL	
PCF 10 & PCF 10 LED						
1-pole	002550001	002550011	10x38	690V AC / 32A	600V AC/DC / 30A	1
1-pole+N	002550002	002550012	10x38	690V AC / 32A	600V AC/DC / 30A	1
2-pole	002550003	002550013	10x38	690V AC / 32A	600V AC/DC / 30A	1
3-pole	002550004	002550014	10x38	690V AC / 32A	600V AC/DC / 30A	1
3-pole+N	002550005	002550015	10x38	690V AC / 32A	600V AC/DC / 30A	1
EFD 10 & EFD 10 LED						
▶ 1-pole	002540001	002540011	10x38	690V AC/DC / 32A	600V AC/DC / 30A	2
▶ 1-pole+N	002540002	002540012	10x38	690V AC/DC / 32A	600V AC/DC / 30A	2
▶ 2-pole	002540003	002540013	10x38	690V AC/DC / 32A	600V AC/DC / 30A	2
▶ 3-pole	002540004	002540014	10x38	690V AC/DC / 32A	600V AC/DC / 30A	2
▶ 3-pole+N	002540005	002540015	10x38	690V AC/DC / 32A	600V AC/DC / 30A	2

CC Type and J Type Fuse Holders



Pole Configuration	Without Indication	With LED Indication	Fuse Size	SCR	UL Rating	Drawing No.
					Voltage/Amp.	
PCF CC & PCF CC LED						
1-pole	002550101	002550111	CC Type	200 kA	600V AC/DC / 30A	1
2-pole	002550103	002550113	CC Type	200 kA	600V AC/DC / 30A	1
3-pole	002550104	002550114	CC Type	200 kA	600V AC/DC / 30A	1
EFD CC & EFD CC LED						
▶ 1-pole	002540101	002540111	CC Type	200 kA	600V AC / 30A	2
▶ 2-pole	002540103	002540113	CC Type	200 kA	600V AC / 30A	2
▶ 3-pole	002540104	002540114	CC Type	200 kA	600V AC / 30A	2
EFD J30 DC & EFD J30 10 DC LED						
▶ 1-pole	002570101	002570111	J-TYPE	200 kA	600V AC/DC / 30A	3
▶ 2-pole	002570103	002570113	J-TYPE	200 kA	600V AC/DC / 30A	3
▶ 3-pole	002570104	002570114	J-TYPE	200 kA	600V AC/DC / 30A	3

PV Type Fuse Holders



Pole Configuration	Without Indication	With LED Indication	Fuse Size	Max Voltage & Current		Drawing No.
				IEC	UL	
PCF 10 DC & PCF 10 DC LED						
1-pole	002550201	002550211	10x38	1000V DC / 25A	1000V DC / 25A	1
2-pole	002550203	002550213	10x38	1000V DC / 25A	1000V DC / 25A	1
EFH 10 DC & EFH 10 DC LED						
▶ 1-pole	002540201	002540211	10x38	1000V DC / 25A	1000V DC / 25A	2
▶ 2-pole	002540203	002540213	10x38	1000V DC / 25A	1000V DC / 25A	2
EFH 14 DC & EFH 14 DC LED						
▶ 1-pole	002560201	002560211	14x51	1000V DC / 50A	1000V DC / 50A	3
▶ 2-pole	002560203	002560213	14x51	1000V DC / 50A	1000V DC / 50A	3

IEC Type Fuse Holders



Pole Configuration	Without Indication	With LED Indication	Fuse Size	Max Voltage & Current		Drawing No.
				IEC	UL	
EFD 14 & EFD 14 LED						
▶ 1-pole	002560001	002560011	14x51	690V AC / 50A	600V AC/DC / 50A	3
1-pole+N	002560002	002560012	14x51	690V AC / 50A	600V AC/DC / 50A	3
2-pole	002560003	002560013	14x51	690V AC / 50A	600V AC/DC / 50A	3
3-pole	002560004	002560014	14x51	690V AC / 50A	600V AC/DC / 50A	3
3-pole+N	002560005	002560015	14x51	690V AC / 50A	600V AC/DC / 50A	3
EFD 22 & EFD 22 LED						
▶ 1-pole	002570001	002570011	22x58	690V AC / 100A	600V AC/DC / 100A	4
1-pole+N	002570002	002570012	22x58	690V AC / 100A	600V AC/DC / 100A	4
2-pole	002570003	002570013	22x58	690V AC / 100A	600V AC/DC / 100A	4
3-pole	002570004	002570014	22x58	690V AC / 100A	600V AC/DC / 100A	4
3-pole+N	002570005	002570015	22x58	690V AC / 100A	600V AC/DC / 100A	4

FUSE HOLDERS, 10 x 38 mm and CC Type

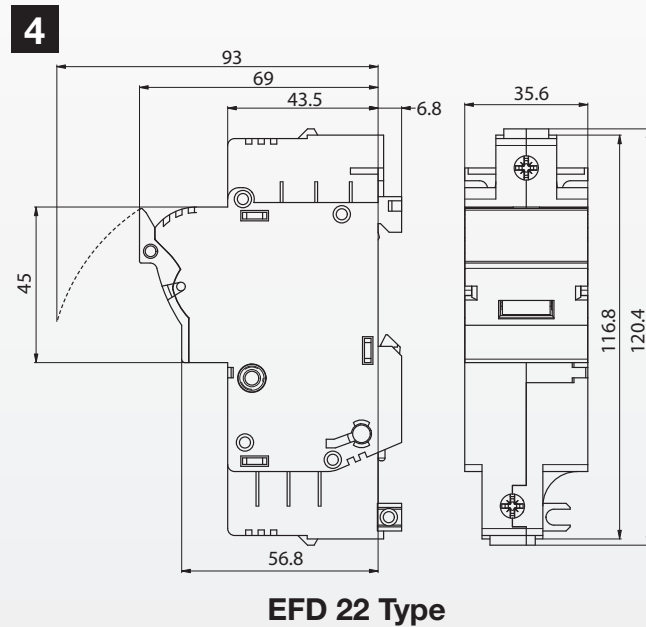
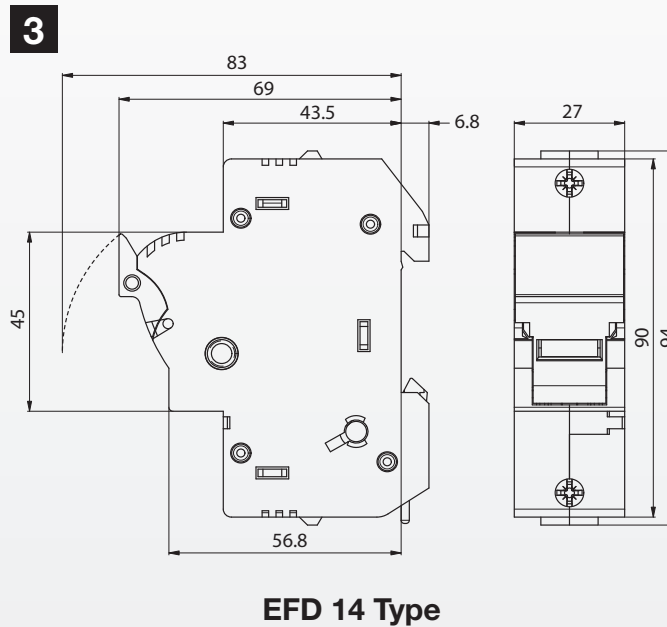
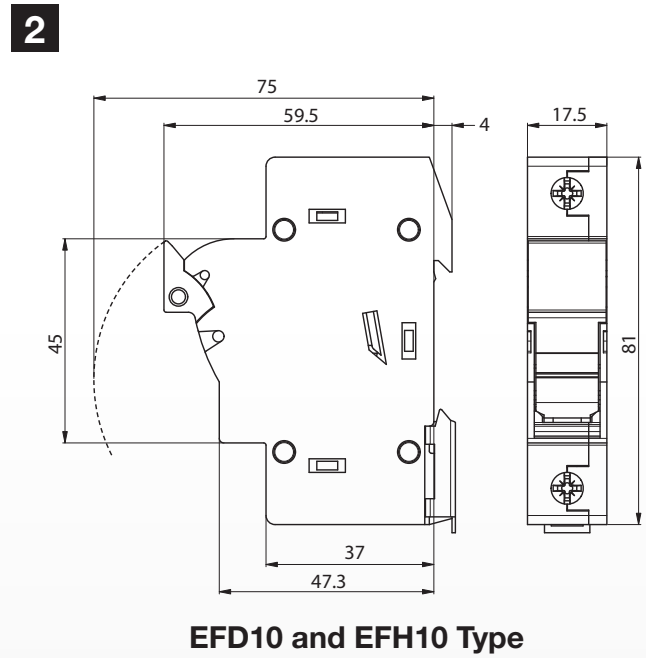
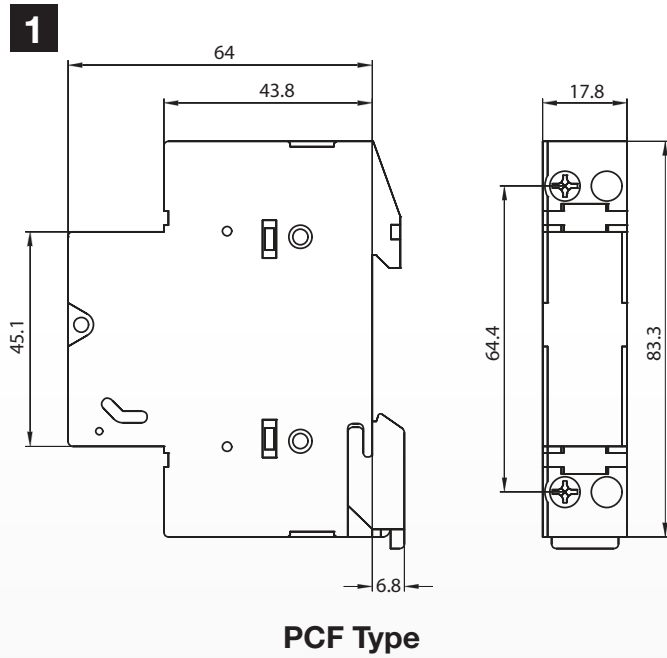

NOTE: All dimensions are shown in millimeters. To convert to inches multiply by 0.03937

Accessories for The Modular Type PCF, EFD and EFH

Modular fuse holders have a unique user configurable feature. By using the modular snap kit (parts sold individually) a customer can configure any pole configuration by inserting the connecting element (3 per pole) into the slot in the side of the fuse holder and then pushing them together and inserting the connecting shaft into the handle.

NOTE: 1 kit suffices for the assembly of 50 sets.



2 Pole Connection Kits

Model No.	Usable with
002540948	EFD 8, EFD 10, EFH 10, PCF 8, PCF 10, EFD CC, PCF CC
002560948	EFD 14, EFH 14
002570948	EFD 22, EFD J30

3 Pole Connection Kits

Model No.	Usable with
002540949	EFD 8, EFD 10, PCF 8, PCF 10, EFD CC, PCF CC
002560949	EFD 14
002570949	EFD 22, EFD J30

Auxiliary Switches

Model No.	Usable with	Type
002559001	PCF 10	1NO/1NC
002569001	EFD 14	1NO/1NC
002579001	EFD 22	1NO/1NC

For Auxiliary switches to operate, a fuse with striker pin must be used.



DISCONNECT & TEST

SCREW TERMINAL BLOCKS

DISCONNECT AND TEST TERMINAL BLOCKS

HIGHLIGHTS

FEATURES

- Slider Style Disconnect Terminals
 - **CDS6U** - Standard Slider Disconnect
 - **CDS6U/TS** - Slider Disconnect with integrated testing points
 - **CDS6U/FT** - Same profile Feed-Through
- Separate Testing points allow insertion of standard test probes
- Disconnect is achieved by operating sliding link with screw driver
- **SLS2, SLS4** slide shorting link system
- **QJ8/2** - Shorting Plug

APPLICATIONS

- (see following page)
- Disconnect & Test Applications
 - Measuring / Control Circuits
 - Utility Instruments and Transformer Applications
 - Meter Replacement
 - External Current Measurement
 - Switch Boards

CDS6U



Slider Disconnect Terminal	
Width	8 mm
Length	82 mm
Height w DIN Rail	35 x 7.5 mm 35 x 15 mm
Weight per piece	33.8 g

CDS6U/TS



Slider Disconnect Terminal Including Test Sockets	
Width	8 mm
Length	82 mm
Height w DIN Rail	51.0 mm 59.2 mm
Weight per piece	33.8 g

CDS6U/FT



Feed Through Terminal with CDS6U profile	
Width	6 mm
Length	82 mm
Height w DIN Rail	51.0 mm 59.2 mm
Weight per piece	21.2 g

Dimensions & Weight

Width	8 mm
Length	82 mm
Height w DIN Rail	35 x 7.5 mm 35 x 15 mm
Weight per piece	33.8 g

Technical Data/Ratings

Approvals	CE, IEC, UL, Lloyd's Register
Wire Size (solid / stranded)	22-8 AWG
Voltage Rating	600 V
Current Rating	45 A
Torque	14 lb-in
Insulation Material	Polyamide 66

Approvals	UL, IEC, UL, Lloyd's Register
Wire Size (solid / stranded)	22-8 AWG
Voltage Rating	600 V
Current Rating	45 A
Torque	14 lb-in
Insulation Material	Polyamide 66

Approvals	UL, IEC, UL, Lloyd's Register
Wire Size (solid / stranded)	22-8 AWG
Voltage Rating	600 V
Current Rating	45 A
Torque	14 lb-in
Insulation Material	Polyamide 66

Approvals	UL, IEC, UL, Lloyd's Register
Wire Size (solid / stranded)	22-8 AWG
Voltage Rating	600 V
Current Rating	45 A
Torque	14 lb-in
Insulation Material	Polyamide 66

Installation Instructions

Wire Stripping Length	10 mm
Screwdriver	Flat Head 0.8 x 4 mm

Wire Stripping Length	10 mm
Screwdriver	Flat Head 0.8 x 4 mm

Wire Stripping Length	10 mm
Screwdriver	Flat Head 0.8 x 4 mm

Wire Stripping Length	10 mm
Screwdriver	Flat Head 0.8 x 4 mm

Terminal Blocks

Grey (standard)	
Red	R
Blue	BU
Black	BL
Orange	O
Green	G
Yellow	Y
White	W

Cat. No.	Std. Pk.
CDS6U	50
CDS6U/R	50
CDS6U/BU	50
CDS6U/BL	50
CDS6U/O	50
CDS6U/G	50
CDS6U/Y	50
CDS6U/W	50

Cat. No.	Std. Pk.
CDS6U/TS	50
CDS6U/TS/R	50
CDS6U/TS/BU	50
CDS6U/TS/BL	50
CDS6U/TS/O	50
CDS6U/TS/G	50
CDS6U/TS/Y	50
CDS6U/TS/W	50

Cat. No.	Std. Pk.
CDS6U/FT	50
CDS6U/FT/R	50
CDS6U/FT/BU	50
CDS6U/FT/BL	50
CDS6U/FT/O	50
CDS6U/FT/G	50
CDS6U/FT/Y	50
CDS6U/FT/W	50

Accessories

End Plate		EPCDS6U	50
DIN Rail	32mm, 35mm	2511120	20
End Stop		CA702	50
Internal Jumper	2 pole, 3 pole, 4 pole, 10 pole	CA723/2	100
Slide Shorting Link	2 pole, 3 pole, 4 pole	SLS2	50
Insulated Test Socket	grey, red, yellow, blue, black	TPSLS	100
Lock Out Cap		LCCDS	50
Shorting Plug		QJ8/2	25
Marking Tag		MT6	1 Pk. (100 tags)

Cat. No.	Std. Pk.
EPCDS6U	50
2511120	20
CA701-15/S	20
2511160	10
CA702	50
CA802	50
CA202	25
CA723/2	100
CA723/3	50
CA723/4	50
CA723/10	10
SLS2	50
SLS3	25
SLS4	25
TPSLS	100
TPSLSR	100
TPSLSY	100
TPSLSBU	100
TPSLSBK	100
LCCDS	50
QJ8/2	25
MT6	1 Pk. (100 tags)

Cat. No.	Std. Pk.
EPCDS6U	50
2511120	20
CA701-15/S	20
2511160	10
CA702	50
CA802	50
CA202	25
CA723/2	100
CA723/3	50
CA723/4	50
CA723/10	10
SLS2	50
SLS3	25
SLS4	25
TPSLS	100
TPSLSR	100
TPSLSY	100
TPSLSBU	100
TPSLSBK	100
LCCDS	50
QJ8/2	25
MT6	1 Pk. (100 tags)

Cat. No.	Std. Pk.
EPCDS6U	50
2511120	20
CA701-15/S	20
2511160	10
CA702	50
CA802	50
CA202	25
CA723/2	100
CA723/3	50
CA723/4	50
CA723/10	10
TPSLS	100
TPSLSR	100
TPSLSY	100
TPSLSBU	100
TPSLSBK	100
LCCDS	50
QJ8/2	25
MT8	1 Pk. (100 tags)

Single Phase Current Transformer Test Circuit

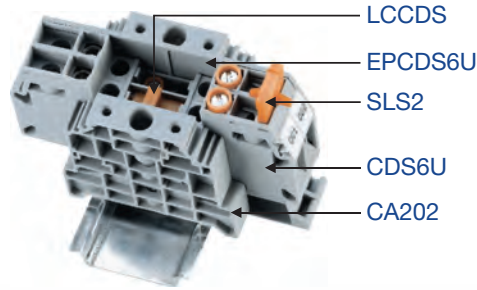

3 Phase current Transformer Test Set

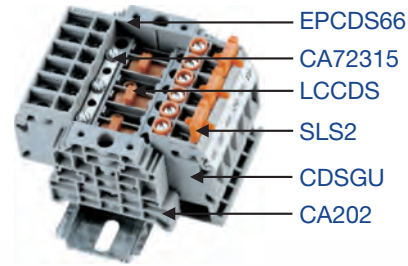

Operating status

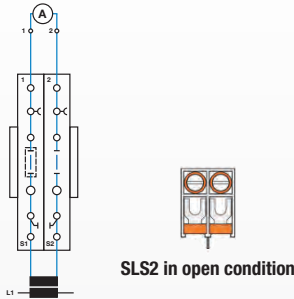

Operating status

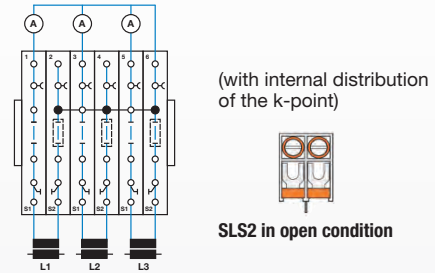

Comparison measurement for L1

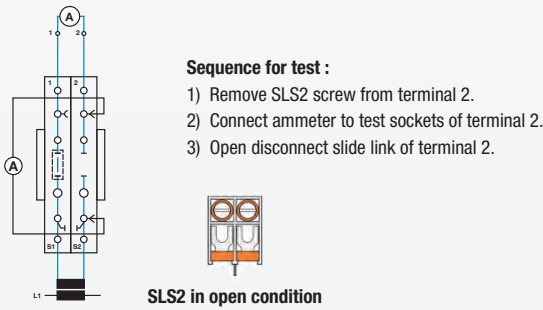

Comparison measurement for L1

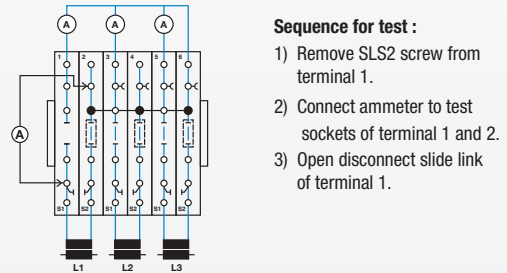

Meter test for L1 through external power supply

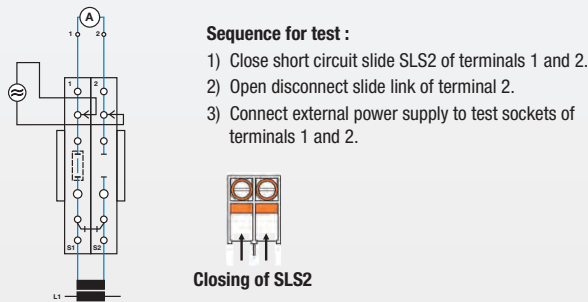

Meter test for L1 through external power supply

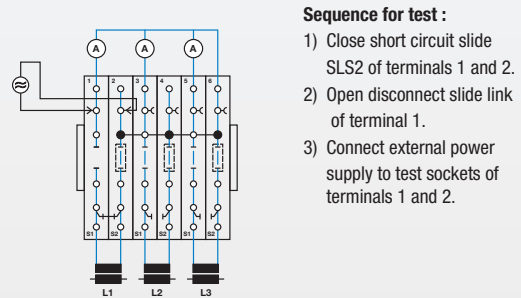

Meter replacement

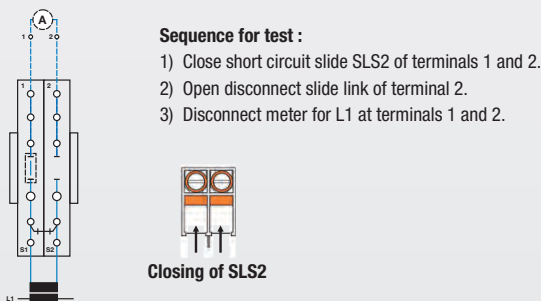

Meter Replacement for L1

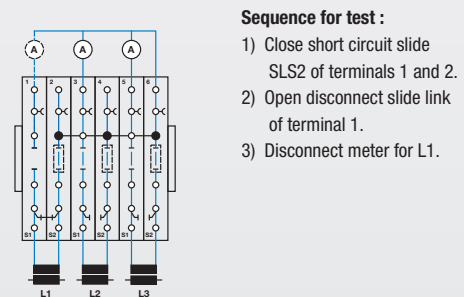

DISCONNECT & TEST

SCREW TERMINAL BLOCKS

BLADE/KNIFE STYLE DISCONNECT TERMINAL BLOCKS

HIGHLIGHTS

FEATURES

- Knife / Blade Style Disconnect Terminals
 - **CKT4U** - Standard Knife Disconnect
 - **CKT4U/4** - 4 Connection Knife Disconnect
- Specially designed socket headed screws act as fast monitoring points

APPLICATIONS

- Disconnect & Test Applications

CKT4U



CKT4U/4



Dimensions & Weight

	Knife Style Disconnect 2 Connections	Knife Style Disconnect 4 Connections
Width	6 mm	6 mm
Length	46.3 mm	65.0 mm
Height w DIN Rail	48.3 mm 35 x 15 mm	54.3 mm 62.0 mm
Weight per piece	10.5 g	16.6 g

Technical Data/Ratings

Approvals					
Wire Size (solid / stranded)	22-10 AWG	22-10 AWG	0.2-4 mm ²	22-10 AWG	0.2-4 mm ²
Voltage Rating	600 V	600 V	800 V	600 V	800 V
Current Rating	35 A	16 A	28 A	20 A	17.5 A
Torque	7 lb-in	7 lb-in	0.5 Nm	7 lb-in	0.5 Nm
Insulation Material	Polyamide 66			Polyamide 66	

Installation Instructions

Wire Stripping Length	8 mm	8 mm
Screwdriver	Flat Head 0.6 x 3.5 mm	Flat Head 0.6 x 3.5 mm

Terminal Blocks

	Cat. No.	Std. Pk.	Cat. No.	Std. Pk.
Grey (standard)	CKT4U	50	CKT4U/4	50
Red R	CKT4U/R	50	CKT4U/4/R	50
Blue BU	CKT4U/BU	50	CKT4U/4/BU	50
Black BL	CKT4U/BL	50	CKT4U/4/BL	50
Orange O	CKT4U/O	50	CKT4U/4/O	50
Green G	CKT4U/G	50	CKT4U/4/G	50
Yellow Y	CKT4U/Y	50	CKT4U/4/Y	50
White W	CKT4U/W	50	CKT4U/4/W	50

Accessories

	Cat. No.	Std. Pk.	Cat. No.	Std. Pk.
End Plate	EPCKT4U	50	EPCKT4U/4	50
DIN Rail	2511120	20	2511120	20
	CA701-15/S	20	CA701-15/S	20
	2511160	10	2511160	10
End Stop	CA702	50	CA702	50
	CA802	50	CA802	50
	CA202	25	CA202	25
External Jumper	2 pole CA714/2	100	CA714/2*	100
	3 pole CA714/3	100	CA714/3*	100
	4 pole CA714/4	100	CA714/4*	100
	10 pole CA714/10	20	CA714/10*	20
Marking Tag	MT6	1 Pk. (100 tags)	MT6	1 Pk. (100 tags)

* Insulated External shorting links can be used only in the upper level clamping unit of the Terminal Block.



HIGHLIGHTS

FEATURES

- Knife Style Disconnect Terminal
- **CF4SPFT** same profile Feed Through Terminal
- **CF4SP** same profile as Fuse Terminal, 5 x 20 mm Fuse Types

APPLICATIONS

- Control Systems with Fuse Protection
- Fused Control Circuits with alternating configurations (CF4SP, CF4SPFT, CGT4SP)
- Switch Boards

Dimensions & Weight

	Knife Style Disconnect Same profile as CF4SP Fuse Block	Feed-Through Terminal Same profile as CF4SP Fuse Block	Fuse Block 5x20 mm Fuse Type
Width	6 mm	6 mm	8 mm
Length	58.5 mm	58.5 mm	57.0 mm
Height w DIN Rail 35 x 7.5 mm 35 x 15 mm	46.0 mm 53.5 mm	46.0 mm 53.5 mm	50.3 mm 57.6 mm
Weight per piece	27.2 g	g	16.9 g

Technical Data/Ratings

Approvals	UL US E220514		IEC 60947-7-1		UL US E220514		IEC 60947-7-1	
Wire Size (solid / stranded)	24-10 AWG	0.2-4 mm ²	24-10 AWG	0.2-4 mm ²	24-10 AWG	0.2-4 mm ²	24-10 AWG	0.2-4 mm ²
Voltage Rating	600 V	1000 V	600 V	1000 V	600 V	1000 V AC/DC	600 V	1000 V AC/DC
Current Rating	30 A	28 A	30 A	32 A	10 A	10 A	10 A	10 A
Torque	4.5 lb-in	0.5 Nm	4.5 lb-in	0.5 Nm	4.5 lb-in	0.5 Nm	4.5 lb-in	0.5 Nm
Insulation Material	Polyamide 66		Polyamide 66		Polyamide 66			

Installation Instructions

Wire Stripping Length	8 mm	8 mm	8 mm
Screwdriver	Flat Head 0.6 x 3.5 mm	Flat Head 0.6 x 3.5 mm	Flat Head 0.6 x 3.5 mm

Terminal Blocks

	Cat. No.	Std. Pk.	Cat. No.	Std. Pk.	Cat. No.	Std. Pk.
Grey (standard)	CKT4SP	50	CF4SPFT	50	CF4SP	50
Red R	CKT4SP/R	50	CF4SPFT/R	50	CF4SP/BU	50
Blue BU	CKT4SP/BU	50	CF4SPFT/BU	50	CF4SP/BL	50
Black BL	CKT4SP/BL	50	CF4SPFT/BL	50		
Orange O	CKT4SP/O	50	CF4SPFT/O	50		
Green G	CKT4SP/G	50	CF4SPFT/G	50		
Yellow Y	CKT4SP/Y	50	CF4SPFT/Y	50		
White W	CKT4SP/W	50	CF4SPFT/W	50		

Accessories

	Cat. No.	Std. Pk.	Cat. No.	Std. Pk.	Cat. No.	Std. Pk.
DIN Rail	2511120	20	2511120	20	2511120	20
	CA701-15/S	20	CA701-15/S	20	CA701-15/S	20
	2511160	10	2511160	10	2511160	10
End Stop	CA702	50	CA702	50	-	-
	CA802	50	CA802	50	-	-
	CA202	25	CA202	25	-	-
Internal Jumper	CA722/2	100	CA722/2	100	CA722/2	100
	CA722/3	100	CA722/3	100	CA722/3	100
	CA722/4	100	CA722/4	100	CA722/4	100
	CA722/10	10	CA722/10	10	CA722/10	10
	CA722/100	10	CA722/100	10	CA722/100	10
Insulated Internal Jumper	CA742/2	100	CA742/2	100	CA742/2	100
	CA742/3	100	CA742/3	100	CA742/3	100
	CA742/4	100	CA742/4	100	CA742/4	100
	CA742/10	10	CA742/10	10	CA742/10	10
	CA742/100	10	CA742/100	10	CA742/100	10
External Jumper	CA714/2	100	CA714/2	100	CA714/2	100
	CA714/3	100	CA714/3	100	CA714/3	100
	CA714/4	100	CA714/4	100	CA714/4	100
	CA714/10	20	CA714/10	20	CA714/10	20
Marking Tag	MT6	1 Pk. (100 tags)	MT6	1 Pk. (100 tags)	MT6	1 Pk. (100 tags)

DISCONNECT & TEST

SCREW TERMINAL BLOCKS

SLIDER STYLE DISCONNECT TERMINAL BLOCKS

HIGHLIGHTS

FEATURES

- Slider Style Disconnect Terminals
 - **CDTTU** - Standard Slider Disconnect
 - **CDTTU-SH** - Double Disconnect Terminal
 - **CDTTUFT** - Same profile Feed-Through
- Specially designed socket headed screws act as fast monitoring points
- Disconnect is achieved by operating sliding link with screw driver

APPLICATIONS

- Disconnect & Test Applications

CDTTU



CDTTU-SH

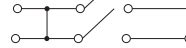

CDTTUFT



Dimensions & Weight

	Slider Disconnect Terminal	Slider Double Disconnect Terminal	Feed Through Terminal Slider Disconnect Profile
Width	8 mm	16 mm	8 mm
Length	63 mm	63 mm	63 mm
Height w DIN Rail	35 x 7.5 mm 35 x 15 mm	58.7 mm 65.7 mm	58.7 mm 65.7 mm
Weight per piece	28.5 g	59.2 g	27.1 g

Technical Data/Ratings

Approvals							
Wire Size (solid / stranded)	16-8 AWG	1.5-10 mm ²	16-8 AWG	16-8 AWG	1.5-10 mm ²	16-8 AWG	1.5-10 mm ²
Voltage Rating	600 V	800 V	300 V	300 V	160 V	600 V	800 V
Current Rating	41 A	57 A	25 A	25 A	10 A	41 A	57 A
Torque	14 lb-in	1.2 Nm	14 lb-in	14 lb-in	1.2 Nm	14 lb-in	1.2 Nm
Insulation Material	Polyamide 66		Polyamide 66			Polyamide 66	

Installation Instructions

Wire Stripping Length	12 mm	12 mm	12 mm
Screwdriver	Flat Head 1.0 x 5.5 mm	Flat Head 1.0 x 5.5 mm	Flat Head 1.0 x 5.5 mm

Terminal Blocks

	Cat. No.	Std. Pk.	Cat. No.	Std. Pk.	Cat. No.	Std. Pk.
Grey (standard)	CDTTU	50	CDTTU-SH	20	CDTTUFT	50
Red R	CDTTU/R	50	CDTTU-SH/R	20	CDTTUFT/R	50
Blue BU	CDTTU/BU	50	CDTTU-SH/BU	20	CDTTUFT/BU	50
Black BL	CDTTU/BL	50	CDTTU-SH/BL	20	CDTTUFT/BL	50
Orange O	CDTTU/O	50	CDTTU-SH/O	20	CDTTUFT/O	50
Green G	CDTTU/G	50	CDTTU-SH/G	20	CDTTUFT/G	50
Yellow Y	CDTTU/Y	50	CDTTU-SH/Y	20	CDTTUFT/Y	50
White W	CDTTU/W	50	CDTTU-SH/W	20	CDTTUFT/W	50

Accessories

	Cat. No.	Std. Pk.	Cat. No.	Std. Pk.	Cat. No.	Std. Pk.
End Plate	EPCDTTU	50	EPCDTTU	50	EPCDTTU	50
DIN Rail	2511120	20	2511120	20	2511120	20
	CA701-15/S	20	CA701-15/S	20	CA701-15/S	20
	2511160	10	2511160	10	2511160	10
End Stop	CA702	50	CA702	50	CA702	50
	CA802	50	CA802	50	CA802	50
	CA202	25	CA202	25	CA202	25
Shorting Plug 2 pole	QJ8/2	25	QJ8/2	25	QJ8/2	25
External Jumper	CA710/2	100	CA710/2	100	CA710/2	100
	CA710/3	50	CA710/3	50	CA710/3	50
	CA710/4	50	CA710/4	50	CA710/4	50
	CA710/10	20	CA710/10	20	CA710/10	20
	CA710/10	20	CA710/10	20	CA710/10	20
Shorting Plug	QJ8/2	25	-	-	QJ8/2	25
Marking Tag	MT8	1 Pk. (100 tags)	MT8	1 Pk. (100 tags)	MT8	1 Pk. (100 tags)

LEVER STYLE DISCONNECT TERMINAL BLOCKS

CSDL4U

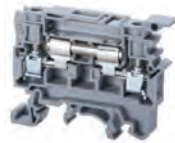

DDDL4U

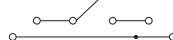

Dimensions & Weight

	Lever Style Disconnect	Lever Style Disconnect Bottom Level Feed Through
Width	8 mm	8 mm
Length	58 mm	88 mm
Height w DIN Rail	35 x 7.5 mm 35 x 15 mm	67.4 mm 74.3 mm
Weight per piece	15.0 g	27.0 g

Technical Data/Ratings

Approvals					
Wire Size (solid / stranded)	22-10 AWG	0.2-4 mm ²	22-10 AWG	22-10 AWG	0.2-4 mm ²
Voltage Rating	600 V	1000 V	600 V	600 V	800 V
Current Rating	Top Bottom	14 A -	6.3 A 35 A	14 A 32 A	10 A 32 A
Torque	7 lb-in	0.5 Nm	7 lb-in	7 lb-in	0.5 Nm
Insulation Material	Polyamide 66		Polyamide 66		

Installation Instructions

Wire Stripping Length	9.5 mm	9.5 mm
Screwdriver	Flat Head 0.6 x 3.5 mm	Flat Head 0.6 x 3.5 mm

Terminal Blocks

	Cat. No.	Std. Pk.	Cat. No.	Std. Pk.
Grey (standard)	CSDL4U	100	DDDL4U	20
Red R	CSDL4U/R	100	DDDL4U/R	20
Blue BU	CSDL4U/BU	100	DDDL4U/BU	20
Black BL	CSDL4U/BL	100	DDDL4U/BL	20
Orange O	CSDL4U/O	100	DDDL4U/O	20
Green G	CSDL4U/G	100	DDDL4U/G	20
Yellow Y	CSDL4U/Y	100	DDDL4U/Y	20
White W	CSDL4U/W	100	DDDL4U/W	20

Accessories

	Cat. No.	Std. Pk.	Cat. No.	Std. Pk.
End Plate	EPCSFL4U	50	EPDDL4U	50
Isolation Partition	PPCSFL4U	50	-	-
DIN Rail	2511120	20	2511120	20
	CA701-15/S	20	CA701-15/S	20
	2511160	10	2511160	10
End Stop	CA702	50	CA702	50
	CA802	50	CA802	50
	CA202	50	CA202	50
Internal Jumper	2 pole	-	CA729/2	100
	3 pole	-	CA729/3	50
	4 pole	-	CA729/4	50
	10 pole	-	CA729/10	10
Insulated Jumper	2 pole	-	CA749/2	100
	3 pole	-	CA749/3	50
	4 pole	-	CA749/4	50
	10 pole	-	CA749/10	10
External Jumper	2 pole	CA711/2	100	CA711/2
	3 pole	CA711/3	50	CA711/3
	4 pole	CA711/4	50	CA711/4
	10 pole	CA711/10	20	CA711/10
Marking Tag	MT8	1 Pk. (100 tags)	MT8	1 Pk. (100 tags)
on terminal on lever	MT2	1 Pk. (100 tags)	MT2	1 Pk. (100 tags)

HIGHLIGHTS

FEATURES

- Lever Style Disconnect Terminals
- CSDL4U - Standard Lever Disconnect
- DDDL4U - Lever Disconnect with Lower Level Feed-Through
- Same profile as CAFL4U

APPLICATIONS

- Disconnect Applications

CDB4/X(1)



HIGHLIGHTS

FEATURES

- Distribution blocks with various output configurations
- Stud/Bolt to secure incoming wire
- Internally connected terminals
- Side/center feed versions
- up to 150A
- Protective shield for incoming wire

APPLICATIONS

- Simplified distribution systems
- Phase distribution application

INSTALLATION NOTES

- Sum of outgoing wires not to exceed incoming current
- Higher output currents should be connected close to the input

Dimensions & Weight

Width	6 Outputs	52.0 mm
	8 Outputs	58.0 mm
	10 Outputs	64.0 mm
	12 Outputs	70.0 mm
	14 Outputs	76.0 mm
	22 Outputs	100.0 mm
24 Outputs	106.0 mm	

Length	43 mm
--------	-------

Height w DIN Rail	35 x 7.5 mm	46.2 mm
	35 x 15 mm	53.7 mm

50A Distribution Terminal Block Side Feed	
Width	52.0 mm
	58.0 mm
	64.0 mm
	70.0 mm
	76.0 mm
	100.0 mm
	106.0 mm
Length	43 mm
Height w DIN Rail	46.2 mm
	53.7 mm

General Specifications

Approvals	
Voltage Rating	600 V
Insulation Material	Polyamide 66

600 V	800 V AC/DC

INPUT

Technical Data/Ratings

Wire Size (solid / stranded)	10-8 AWG	6-16 mm ²
Current Rating	50 A	64 A
Torque	26 lb-in	2.0 Nm

Wire Size (solid / stranded)	22-10 AWG	0.2-4 mm ²
Current Rating	35 A	64 A*
Torque	7 lb-in	0.5 Nm

Installation Instructions

Wire Stripping Length	8 mm
Screwdriver	Hex Nut Driver M8

Wire Stripping Length	8 mm
Screwdriver	Flat Head 0.6 x 3.5 mm

OUTPUT

Technical Data/Ratings

Wire Size (solid / stranded)	22-10 AWG	0.2-4 mm ²
Current Rating	35 A	64 A*
Torque	7 lb-in	0.5 Nm

Wire Size (solid / stranded)	22-10 AWG	0.2-4 mm ²
Current Rating	35 A	64 A*
Torque	7 lb-in	0.5 Nm

Installation Instructions

Wire Stripping Length	8 mm
Screwdriver	Flat Head 0.6 x 3.5 mm

Wire Stripping Length	8 mm
Screwdriver	Flat Head 0.6 x 3.5 mm

Terminal Blocks

Grey (standard)	
6 Outputs	CDB4/2(1)
8 Outputs	CDB4/3(1)
10 Outputs	CDB4/4(1)
12 Outputs	CDB4/5(1)
14 Outputs	CDB4/6(1)
22 Outputs	CDB4/10(1)
24 Outputs	CDB4/11(1)

Cat. No.	Std. Pk.
CDB4/2(1)	10
CDB4/3(1)	10
CDB4/4(1)	10
CDB4/5(1)	5
CDB4/6(1)	5
CDB4/10(1)	5
CDB4/11(1)	5

Accessories

DIN Rail	32mm / 35mm	2511120	20
End Stop		CA702	50
Marking Tag		CA802	50
		MT6	1 Pk. (100 tags)

Cat. No.	Std. Pk.
2511120	20
CA701-15/S	20
2511160	10
CA702	50
CA802	50
MT6	1 Pk. (100 tags)

* Total output current of system

Phase Distribution Application with CDB Terminals

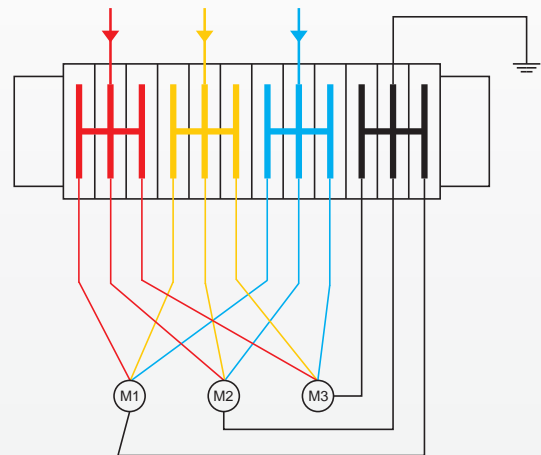



Dimensions & Weight

	50A Distribution Terminal Block Center Feed	100A Distribution Terminal Block Center Feed	130A Distribution Terminal Block Center Feed	150A Distribution Terminal Block Center Feed
Width	4 Outputs 8 Outputs 12 Outputs 16 Outputs 20 Outputs 24 Outputs	44.0 mm 56.0 mm 68.0 mm 80.0 mm 96.0 mm 108.0 mm	48.0 mm 64.0 mm 80.0 mm 96.0 mm -	- 88.0 mm 112.0 mm 136.0 mm -
Length	43 mm	48 mm	48 mm	49 mm
Height w DIN Rail	35 x 7.5 mm 35 x 15 mm	46.2 mm 53.7 mm	47.8 mm 55.5 mm	57.2 mm 64.7 mm

General Specifications

Approvals								
Voltage Rating	600 V	800 V AC/DC	600 V	800 V AC/DC	600 V	800 V AC/DC	600 V	800 V AC/DC
Insulation Material	Polyamide 66		Polyamide 66		Polyamide 66		Polyamide 66	

INPUT

Technical Data/Ratings

Wire Size (solid / stranded)	10-8 AWG	6-16 mm ²	10-2 AWG	6-25 mm ²	8-1/0 AWG	10-35 mm ²	6-2/0 AWG	10-50 mm ²
Current Rating	50 A	64 A	100 A	82 A	130 A	114 A	150 A	150 A
Torque	26 lb-in	2.0 Nm	35 lb-in	3.0 Nm	53 lb-in	6.0 Nm	53 lb-in	6.0 Nm

Installation Instructions

Wire Stripping Length	8 mm	9 mm	11 mm	14 mm
Screwdriver	Hex Nut Driver M8	Hex Nut Driver M10	Hex Nut Driver M13	Hex Nut Driver M15

OUTPUT

Technical Data/Ratings

Wire Size (solid / stranded)	22-10 AWG	0.2-4 mm ²	22-8 AWG	1.5-6 mm ²	22-6 AWG	1.5-10 mm ²	12-2 AWG	6-25 mm ²
Current Rating (per output)	35 A	32 A	50 A	41 A	65 A	57 A	75 A	75 A
Torque	7 lb-in	0.5 Nm	14 lb-in	0.8 Nm	14 lb-in	1.2 Nm	22 lb-in	2.0 Nm

Installation Instructions

Wire Stripping Length	8 mm	9 mm	11 mm	14 mm
Screwdriver	Flat Head 0.6 x 3.5 mm	Flat Head 0.8 x 4 mm	Flat Head 0.8 x 4 mm	Flat Head 1.0 x 5.5 mm

Terminal Blocks

	Cat. No.	Std. Pk.	Cat. No.	Std. Pk.	Cat. No.	Std. Pk.	Cat. No.	Std. Pk.
Grey (standard)								
4 Outputs	CDB4/1	10	CDB6/1	10	-	-	CDB25/1	10
8 Outputs	CDB4/2	10	CDB6/2	10	CDB10/2	10	CDB25/2	10
12 Outputs	CDB4/3	10	CDB6/3	10	CDB10/3	10	CDB25/3	10
16 Outputs	CDB4/4	10	CDB6/4	5	CDB10/4	5	CDB25/4	5
20 Outputs	CDB4/5	5	-	-	-	-	-	-
24 Outputs	CDB4/6	5	-	-	-	-	-	-

Accessories

	Cat. No.	Std. Pk.	Cat. No.	Std. Pk.	Cat. No.	Std. Pk.	Cat. No.	Std. Pk.
DIN Rail								
32mm	2511120	20	2511120	20	2511120	20	2511120	20
35mm	CA701-15/S	20	CA701-15/S	20	CA701-15/S	20	CA701-15/S	20
	2511160	10	2511160	10	2511160	10	2511160	10
End Stop	CA702	50	CA702	50	CA702	50	CA702	50
	CA802	50	CA802	50	CA802	50	CA802	50
Marking Tag	MT6	1 Pk. (100 tags)	MT8	1 Pk. (100 tags)	MT10	1 Pk. (100 tags)	MT12	1 Pk. (100 tags)

CMDB4/X



CMDB6/X



CMDB10/X



CMDB25/X



Dimensions

	35 A Distribution Terminal Block	50 A Distribution Terminal Block	65 A Distribution Terminal Block	85 A Distribution Terminal Block	
Width	2 pole 3 pole 4 pole 10 pole	13.5 mm 19.5 mm 25.5 mm 61.5 mm	17.5 mm 25.5 mm 33.5 mm 81.5 mm	21.5 mm 31.5 mm 41.5 mm 101.5 mm	26.0 mm 38.0 mm 50.0 mm 62.0 mm
Length	43 mm	48 mm	48 mm	49 mm	
Height w DIN Rail	35 x 7.5 mm 35 x 15 mm	46.2 mm 53.7 mm	47.8 mm 55.5 mm	47.8 mm 55.5 mm	57.2 mm 64.7 mm

Technical Data/Ratings

Approvals								
Wire Size (solid / stranded)	22-10 AWG	0.2-4 mm ²	22-8 AWG	1.5-6 mm ²	22-6 AWG	1.5-10 mm ²	12-4 AWG	6.0-25 mm ²
Voltage Rating	600 V	1000V AC/DC	600 V	1000V AC/DC	600 V	1000V AC/DC	600 V	800V AC/DC
Current Rating	35 A	32 A	50 A	41 A	65 A	57 A	85 A	101 A
Torque	7 lb-in	0.5 Nm	14 lb-in	0.8 Nm	14 lb-in	1.2 Nm	22 lb-in	2.0 Nm
Insulation Material	Polyamide 66		Polyamide 66		Polyamide 66		Polyamide 66	

Installation Instructions

Wire Stripping Length	8 mm	9 mm	11 mm	14 mm
Screwdriver	Flat Head 0.6 x 3.5 mm	Flat Head 0.8 x 4 mm	Flat Head 0.8 x 4 mm	Flat Head 1.0 x 5.5 mm

Terminal Blocks

4 Outputs

	Cat. No.	Std. Pk.	Cat. No.	Std. Pk.	Cat. No.	Std. Pk.	Cat. No.	Std. Pk.
Grey (standard)	CMDB4/2	10	CMDB6/2	10	CMDB10/2	10	CMDB25/2	10
Red R	CMDB4/2/R	10	CMDB6/2/R	10	CMDB10/2/R	10	CMDB25/2/R	10
Blue BU	CMDB4/2/BU	10	CMDB6/2/BU	10	CMDB10/2/BU	10	CMDB25/2/BU	10
Black BL	CMDB4/2/BL	10	CMDB6/2/BL	10	CMDB10/2/BL	10	CMDB25/2/BL	10

6 Outputs

	Cat. No.	Std. Pk.	Cat. No.	Std. Pk.	Cat. No.	Std. Pk.	Cat. No.	Std. Pk.
Grey (standard)	CMDB4/3	10	CMDB6/3	10	CMDB10/3	10	CMDB25/3	10
Red R	CMDB4/3/R	10	CMDB6/3/R	10	CMDB10/3/R	10	CMDB25/3/R	10
Blue BU	CMDB4/3/BU	10	CMDB6/3/BU	10	CMDB10/3/BU	10	CMDB25/3/BU	10
Black BL	CMDB4/3/BL	10	CMDB6/3/BL	10	CMDB10/3/BL	10	CMDB25/3/BL	10

8 Outputs

	Cat. No.	Std. Pk.	Cat. No.	Std. Pk.	Cat. No.	Std. Pk.	Cat. No.	Std. Pk.
Grey (standard)	CMDB4/4	10	CMDB6/4	10	CMDB10/4	10	CMDB25/4	10
Red R	CMDB4/4/R	10	CMDB6/4/R	10	CMDB10/4/R	10	CMDB25/4/R	10
Blue BU	CMDB4/4/BU	10	CMDB6/4/BU	10	CMDB10/4/BU	10	CMDB25/4/BU	10
Black BL	CMDB4/4/BL	10	CMDB6/4/BL	10	CMDB10/4/BL	10	CMDB25/4/BL	10

20 Outputs

	Cat. No.	Std. Pk.	Cat. No.	Std. Pk.	Cat. No.	Std. Pk.	Cat. No.	Std. Pk.
Grey (standard)	CMDB4/10	10	CMDB6/10	10	CMDB10/10	5	CMDB25/10	10
Red R	CMDB4/10/R	10	CMDB6/10/R	10	CMDB10/10/R	5	CMDB25/10/R	10
Blue BU	CMDB4/10/BU	10	CMDB6/10/BU	10	CMDB10/10/BU	5	CMDB25/10/BU	10
Black BL	CMDB4/10/BL	10	CMDB6/10/BL	10	CMDB10/10/BL	5	CMDB25/10/BL	10

Accessories

	Cat. No.	Std. Pk.	Cat. No.	Std. Pk.	Cat. No.	Std. Pk.	Cat. No.	Std. Pk.
DIN Rail	2511120	20	2511120	20	2511120	20	2511120	20
	CA701-15/S	20	CA701-15/S	20	CA701-15/S	20	CA701-15/S	20
	2511160	10	2511160	10	2511160	10	2511160	10
End Stop	CA702	50	CA702	50	CA702	50	CA702	50
	CA802	50	CA802	50	CA802	50	CA802	50
Marking Tag	MT6	1 Pk. (100 tags)	MT8	1 Pk. (100 tags)	MT10	1 Pk. (100 tags)	MT12	1 Pk. (100 tags)

CXDB35/10

CXDB35/10A

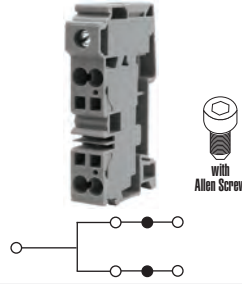

1 Flat Head Screw Input
4 Spring Clamp Outputs

1 Hex Screw Input
4 Spring Clamp Outputs

Dimensions & Weight

Width	16 mm	16 mm
Length	81.6 mm	81.6 mm
Height w DIN Rail	35 x 7.5 mm 35 x 15 mm	46.8 mm 54.3 mm
Weight per piece	53.2 g	53.2 g

General Specifications

Approvals		
Voltage Rating	600 V 1000V AC/DC	600 V 1000V AC/DC
Insulation Material	Polyamide 66	Polyamide 66

INPUT

Technical Data/Ratings

Wire Size (solid / stranded)	14-2 AWG 1.5-35 mm ²	14-2 AWG 1.5-35 mm ²
Current Rating	115 A 125 A	115 A 125 A
Torque	25 lb-in 2.5 Nm	25 lb-in 2.5 Nm

Installation Instructions

Wire Stripping Length	17 mm	17 mm
Screwdriver	Flat Head 1.0 x 5.5 mm	Hex Screw M5

OUTPUT

Technical Data/Ratings

Wire Size (solid / stranded)	24-8 AWG 0.2-10 mm ²	24-8 AWG 0.2-10 mm ²
Current Rating	41 A 41 A	41 A 41 A

Installation Instructions

Wire Stripping Length	15 mm	15 mm
Screwdriver	Flat Head 0.8 x 4 mm	Flat Head 0.8 x 4 mm

Terminal Blocks

	Cat. No.	Std. Pk.	Cat. No.	Std. Pk.
Grey	CXDB35/10	20	CXDB35/10A	20

Accessories

	Cat. No.	Std. Pk.	Cat. No.	Std. Pk.
DIN Rail	2511120 CA701-15/S	20 20	2511120 CA701-15/S	20 20
End Clamp	CA702 CA802 CA103	50 50 50	CA702 CA802 CA103	50 50 50
Jumpers	JX6/2 JX6/3 JX6/4 JX6/10	100 50 50 10	JX6/2 JX6/3 JX6/4 JX6/10	100 50 50 10
Marking Tag	MT16	1 Pk. (100 tags)	MT16	1 Pk. (100 tags)

HIGHLIGHTS

FEATURES

- Hybrid Distribution Terminal Block
- Screw input (115A)
- 4 spring clamp outputs (4 x41A)
- Modular system
- Standard slot & hex screw versions
- Expandable with standard CX Series jumpers and terminal blocks
- Easy Installation

APPLICATIONS

- Miniature Circuit Breaker (MCB) distribution
- Limited space distribution

Output Expansion

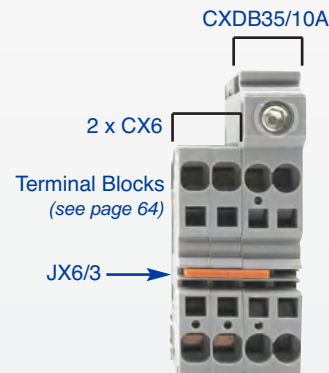

MCB Distribution Example

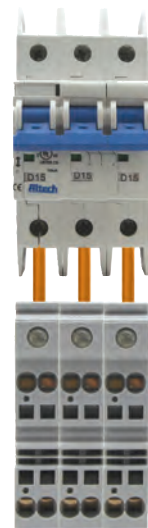

HIGHLIGHTS

FEATURES

- 3 Clamp Sizes
- Panel Mount
 - NES
 - NEB6
- DIN Rail Mount
 - CA202
 - NEB10
- Tin Plated Copper Busbars
- Busbar Current rating 140A
- Standard Color: Green
- Various colors

APPLICATIONS

- Grounding Solution
- Terminating Neutral an Grounding Wires to a single busbar
- Distribution Applications



Dimensions & Weight

	CENC4	CENC16	CENC35
Width	7.5 mm	9.8 mm	14.5 mm
Length	23.3 mm	23.3 mm	27.3 mm
Weight per piece	8 g	10.5 g	20 g

Technical Data/Ratings

Approvals									
Wire Size (solid / stranded)	22-12 AWG	22-12 AWG	0.2-6 mm ²	10-6 AWG	10-6 AWG	10-16 mm ²	8-2 AWG	8-2 AWG	10-35 mm ²
Voltage Rating	600 V	600 V	800 V	600 V	600 V	800 V	600 V	600 V	800 V
Current Rating	-	-	37 A	-	-	76 A	-	-	125 A
Torque	14 lb-in	14 lb-in	0.8 Nm	17.5 lb-in	17.5 lb-in	2.0 Nm	25 lb-in	25 lb-in	2.5 Nm
Insulation Material	Polyamide 66			Polyamide 66			Polyamide 66		

Installation Instructions

	CENC4	CENC16	CENC35
Wire Stripping Length	12 mm	16 mm	16 mm
Screwdriver	Flat Head 0.8 x 4 mm	Flat Head 1.0 x 5.5 mm	Flat Head 1.0 x 5.5 mm

Terminal Blocks

	Cat. No.	Std. Pk.	Cat. No.	Std. Pk.	Cat. No.	Std. Pk.
Green (standard)			CENC16	50	CENC35	50
Black BL	CENC4/BL	50	CENC16/BL	50	CENC35/BL	50
Blue BU	CENC4/BU	50	CENC16/BU	50	CENC35/BU	50
Grey GR	CENC4/GR	50	CENC16/GR	50	CENC35/GR	50
Yellow Y	CENC4/Y	50	CENC16/Y	50	CENC35/Y	50

Mounting Accessories

Panel Mount

	Cat. No.	Std. Pk.	Cat. No.	Std. Pk.	Cat. No.	Std. Pk.
Busbar (6 x 6 mm)	NEB6	1 m	NEB6	1 m	NEB6	1 m
Plastic Support with Fixing Screw	NES	50	NES	50	NES	50
Marking Tag	MT5	1 Pk. (100 tags)	MT6	1 Pk. (100 tags)	MT6	1 Pk. (100 tags)

Mounting Accessories

DIN Rail Mount

	Cat. No.	Std. Pk.	Cat. No.	Std. Pk.	Cat. No.	Std. Pk.
Busbar (10 x 3 mm)	NEB10	1 m	NEB10	1 m	NEB10	1 m
End Clamp/Busbar support for rail mounting	CA202	50	CA202	50	CA202	50
Marking Tag	MT5	1 Pk. (100 tags)	MT6	1 Pk. (100 tags)	MT6	1 Pk. (100 tags)

Panel Mount Assembly Example

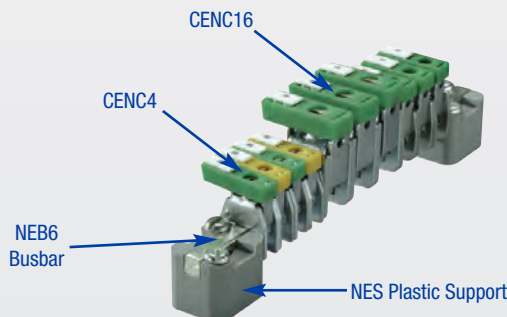

DIN Rail Mount Assembly Example

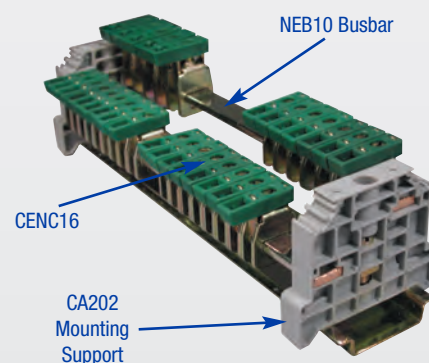

CHV4U

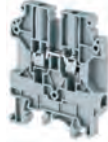

CHV6U



CHV10U



Dimensions & Weight

Width	6 mm	8 mm	10 mm
Length	52 mm	52 mm	52 mm
Height w/ DIN Rail	35 x 7.5 mm 35 x 15 mm	63.4 mm 70.8 mm	63.4 mm 70.8 mm
Weight per piece	11.0 g	16.0 g	21.6 g

Technical Data/Ratings

Approvals			
Wire Size (solid / stranded)	22-10 AWG	0.2-4 mm ²	22-8 AWG
Voltage Rating	1000 V	1500 V AC/DC	1000 V
Current Rating	35 A	32 A	50 A
Torque	7 lb-in	0.5 Nm	14 lb-in
Insulation Material	Polyamide 66		

Installation Instructions

Wire Stripping Length	12 mm	14 mm	14 mm
Screwdriver	Flat Head 0.6 x 3.5 mm	Flat Head 0.8 x 4 mm	Flat Head 0.8 x 4 mm

Terminal Blocks

	Cat. No.	Std. Pk.	Cat. No.	Std. Pk.	Cat. No.	Std. Pk.
Grey (standard)	CHV4U	50	CHV6U	50	CHV10U	50
Red R	CHV4U/R	50	CHV6U/R	50	CHV10U/R	50
Blue BU	CHV4U/BU	50	CHV6U/BU	50	CHV10U/BU	50
Black BL	CHV4U/BL	50	CHV6U/BL	50	CHV10U/BL	50
Orange O	CHV4U/O	50	CHV6U/O	50	CHV10U/O	50
Green G	CHV4U/G	50	CHV6U/G	50	CHV10U/G	50
Yellow Y	CHV4U/Y	50	CHV6U/Y	50	CHV10U/Y	50
White W	CHV4U/W	50	CHV6U/W	50	CHV10U/W	50

Accessories

	Cat. No.	Std. Pk.	Cat. No.	Std. Pk.	Cat. No.	Std. Pk.
End Plate	EPUSC	50	EPUSC	50	EPUSC	50
Separator Plate	SP2.5/4UN	50	SP2.5/4UN	50	SP2.5/4UN	50
DIN Rail	2511120	20	2511120	20	2511120	20
	CA701-15/S	20	CA701-15/S	20	CA701-15/S	20
	2511160	10	2511160	10	2511160	10
End Stop	CA702	50	CA702	50	CA702	50
	CA802	50	CA802	50	CA802	50
	CA202	25	CA202	25	CA202	25
Internal Jumper	2 pole CA623/2	100	2 pole CA624/2	100	2 pole CA625/2	100
	3 pole CA623/3	100	3 pole CA624/3	100	3 pole CA625/3	100
	4 pole CA623/4	100	4 pole CA624/4	100	4 pole CA625/4	100
	10 pole CA623/10	10	10 pole CA624/10	10	10 pole CA625/10	10
Marking Tag	MT6	1 Pk. (100 tags)	MT8	1 Pk. (100 tags)	MT10	1 Pk. (100 tags)

HIGHLIGHTS

FEATURES

- High Voltage Terminal Blocks
- 1000V UL Rating
- 1500V IEC DC Rating
- Same Profile on all Current Ratings

APPLICATIONS

- Solar Applications
- High Voltage Applications

THERMOCOUPLE

SCREW TERMINAL BLOCKS

THERMOCOUPLE BLOCKS

HIGHLIGHTS

FEATURES

- Thermocouple terminal blocks are used to extend thermocouple compensating lines in measuring circuits
- The current bar of the terminal block is made of the same material as the thermocouple wire (As per EN 60584/DINEN 60584)
- No loss of potential at the connection points
- Available types:
 - K Type** - Chromel (NiCr), Alumel (Ni)
 - J Type** - Iron (Fe), Constantan (CuNi)
 - T Type** - Copper (Cu), Constantan (CuNi)
 - E Type** - Chromel (NiCr), Constantan (CuNi)

APPLICATIONS

- Measurement applications

CTT2.5UK/J/T/E

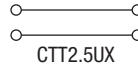

Dimensions & Weight

Width	10 mm	
Length	43 mm	
Height w DIN Rail	35 x 7.5 mm	46.2 mm
	35 x 15 mm	53.7 mm
Weight per piece	12.4 g	

Technical Data/Ratings

Approvals		
Wire Size (solid / stranded)	22-14 AWG	0.2-2.5 mm ²
Voltage Rating	1000 V AC/DC	
Current Rating	10 A	
Torque	7 lb-in / 0.4 Nm	
Insulation Material	Polyamide 66	

Installation Instructions

Wire Stripping Length	8 mm
Screwdriver	Flat Head 0.5 x 3 mm

Terminal Blocks

	Cat. No.	Std. Pk.
Grey		
U Type	CTT2.5UK	50
J Type	CTT2.5UJ	50
T Type	CTT2.5UT	50
G Type	CTT2.5UG	50

Accessories

	Cat. No.	Std. Pk.
End Plate	EP2.5/4UN	50
Partition Plate	PP2.5/4UN	50
DIN Rail	2511120	20
	CA701-15/S	20
	2511160	10
End Stop	CA702	100
	CA802	100
Marking Tag	INCLUDED	

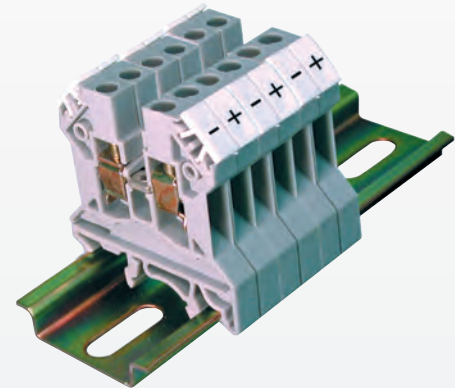

Typical Temperature Measuring Circuit

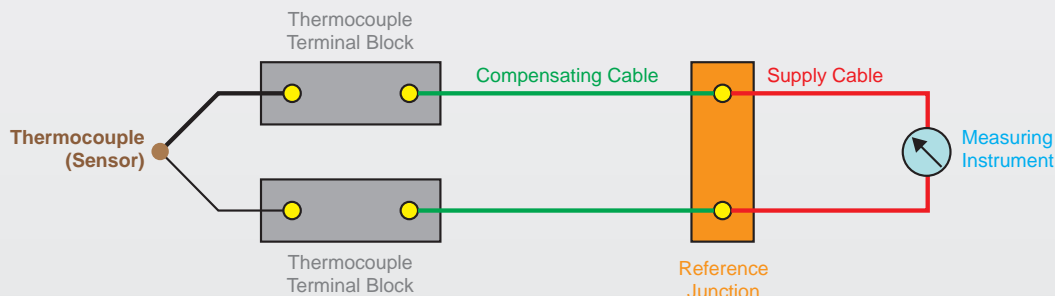

CTC4U

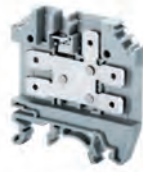

Dimensions & Weight

Width	6 mm
Length	47 mm
Height w DIN Rail	35 x 7.5 mm 35 x 15 mm
Weight per piece	8.0 g

Technical Data/Ratings

Approvals	
Wire Size (solid stranded)	0.2-4.0 mm ² 24-12 AWG
Voltage Rating	300 V
Current Rating	32 A
Tab (Blade) Size	6.3x0.8 mm
Insulation Material	Polyamide 66

Installation Instructions

Wire Stripping Length	9 mm
-----------------------	------

Terminal Blocks

	Cat. No.	Std. Pk.
Grey (standard)	CTC4U	100
Red R	CTC4U/R	100
Blue BU	CTC4U/BU	100
Black BL	CTC4U/BL	100
Orange O	CTC4U/O	100
Green G	CTC4U/G	100
Yellow Y	CTC4U/Y	100
White W	CTC4U/W	100

Accessories

	Cat. No.	Std. Pk.
End Plate	EPCTC4U	50
DIN Rail	2511120	20
	CA701-15/S	20
	2511160	10
End Stop	CA702	100
	CA802	100
Test Socket	CA707/TS/01	
Marking Tag	MT6	1 Pk. (100 tags)

HIGHLIGHTS

FEATURES

- Standard tab connection terminals
- Quick-Connect Tabs

APPLICATIONS

- Transportation
- Railroad Applications



SPRING LOADED

SCREW TERMINAL BLOCKS

FEED-THROUGH TERMINAL BLOCKS

HIGHLIGHTS

FEATURES

- Feed Through Terminals with Springs below clamps
- High torque screws
- Built-in springs guarantee secure connection even when screw is not tight
- 4 mm, 6 mm, 10mm terminal blocks with same size profile
- It is recommended to use hook type lugs/ ferrules for wire termination
- Both, high-torque screws and built-in spring
- Various disconnect terminals

APPLICATIONS

- Vibration Applications
- Projects which follow the following safety regulations:
 - Electric Supply Standard (ESI)
 - British CEGB Standard
 - NTPC standard

CTS4USC



CTS6USC



CTS10USC



Dimensions & Weight

	Feed Through Terminal Spring Loaded	Feed Through Terminal Spring Loaded	Feed Through Terminal Spring Loaded
Width	6 mm	8 mm	10 mm
Length	52 mm	52 mm	52 mm
Height w DIN Rail	35 x 7.5 mm 35 x 15 mm	63.4 mm 70.8 mm	63.4 mm 70.8 mm
Weight per piece	13.0 g	10.0 g	12.6 g

Technical Data/Ratings

Approvals						
Wire Size (solid / stranded)	22-10 AWG	0.2-4 mm ²	22-8 AWG	0.2-6 mm ²	20-6 AWG	0.2-10 mm ²
Voltage Rating	600 V	1500V AC/DC	1000 V	1500V AC/DC	1000 V	1500V AC/DC
Current Rating	35 A	32 A	50 A	41 A	65 A	57 A
Torque	7 lb-in	0.5 Nm	14 lb-in	0.8 Nm	14 lb-in	1.2 Nm
Insulation Material	Polyamide 66		Polyamide 66		Polyamide 66	

Installation Instructions

Wire Stripping Length	12 mm	14 mm	14 mm
Screwdriver	Flat Head 0.6 x 3.5 mm	Flat Head 0.8 x 4 mm	Flat Head 0.8 x 4 mm

Terminal Blocks

	Cat. No.	Std. Pk.	Cat. No.	Std. Pk.	Cat. No.	Std. Pk.
Grey (standard)	CTS4USC	50	CTS6USC	50	CTS10USC	50
Red R	CTS4USC/R	50	CTS6USC/R	50	CTS10USC/R	50
Blue BU	CTS4USC/BU	50	CTS6USC/BU	50	CTS10USC/BU	50
Black BL	CTS4USC/BL	50	CTS6USC/BL	50	CTS10USC/BL	50
Orange O	CTS4USC/O	50	CTS6USC/O	50	CTS10USC/O	50
Green G	CTS4USC/G	50	CTS6USC/G	50	CTS10USC/G	50
Yellow Y	CTS4USC/Y	50	CTS6USC/Y	50	CTS10USC/Y	50
White W	CTS4USC/W	50	CTS6USC/W	50	CTS10USC/W	50

Accessories

	Cat. No.	Std. Pk.	Cat. No.	Std. Pk.	Cat. No.	Std. Pk.
End Plate	EPUSC	50	EPUSC	50	EPUSC	50
Separator Plate	SP2.5/4UN	50	SP2.5/4UN	50	SP2.5/4UN	50
DIN Rail	2511120 CA701-15/S 2511160	20 20 10	2511120 CA701-15/S 2511160	20 20 10	2511120 CA701-15/S 2511160	20 20 10
End Stop	CA702 CA802 CA202	100 50 50	CA702 CA802 CA202	100 50 50	CA702 CA802 CA202	100 50 50
Hook Type Lug / Ferrule	1.5 mm ² 2.5 mm ² 4 mm ² 6 mm ² 10 mm ²	CA604/1 CA604/2 CA604/5 - -	100 100 100 - -	CA604/1 CA604/2 CA604/5 CA604/4 -	100 100 100 100 -	CA604/1 CA604/2 CA604/5 CA604/4 CA604/3
Pre Assembled Jumpers	2 pole 3 pole 4 pole 10 pole	CA623/2 CA623/3 CA623/4 CA623/10	100 100 100 10	CA624/2 CA624/3 CA624/4 CA624/10	100 100 100 10	CA625/2 CA625/3 CA625/4 CA625/10
Marking Tag	MT6	1 Pk. (100 tags)	MT8	1 Pk. (100 tags)	MT10	1 Pk. (100 tags)

CKT4SPSC

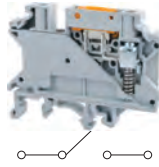

CDS6U/SC

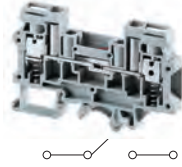

CDTTUSC

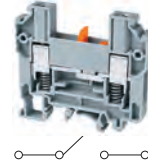

CDTTUFTSC

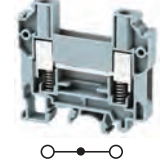

Dimensions & Weight

	Knife Disconnect Spring Loaded Terminal	Slider Disconnect Spring Loaded Terminal	Slider Disconnect Spring Loaded Terminal	Feed Through Terminal Same profile as CDTTUSC
Width	6 mm	8 mm	8 mm	8 mm
Length	58.5 mm	82 mm	63 mm	63 mm
Height w DIN Rail	35 x 7.5 mm 35 x 15 mm	46.0 mm 53.5 mm	51.0 mm 59.2 mm	58.7 mm 65.7 mm
Weight per piece	14.1 g	30.9 g	31.0 g	25.4 g

Technical Data/Ratings

Approvals								
Wire Size (solid / stranded)	24-10 AWG	0.2-4 mm ²	22-8 AWG	0.2-6 mm ²	16-8 AWG	1.5-10 mm ²	16-8 AWG	1.5-10 mm ²
Voltage Rating	600 V	1000V AC/DC	600 V	800V AC/DC	600 V	800V AC/DC	600 V	800V AC/DC
Current Rating	30 A	28 A	45 A	41 A	41 A	57 A	41 A	57 A
Torque	4.5 lb-in	0.5Nm	14 lb-in	0.8 Nm	14 lb-in	1.2Nm	14 lb-in	1.2Nm
Insulation Material	Polyamide 66		Polyamide 66		Polyamide 66		Polyamide 66	

Installation Instructions

Wire Stripping Length	8 mm	10 mm	12 mm	12 mm
Screwdriver	Flat Head 0.6 x 3.5 mm	Flat Head 0.8 x 4 mm	Flat Head 1.0 x 5.5 mm	Flat Head 1.0 x 5.5 mm

Terminal Blocks

	Cat. No.	Std. Pk.	Cat. No.	Std. Pk.	Cat. No.	Std. Pk.	Cat. No.	Std. Pk.
Grey (standard)	CKT4SPSC	50	CDS6U/SC	50	CDTTUSC	50	CDTTUFTSC	50
Red R	CKT4SPSC/R	50	CDS6U/SC/R	50	CDTTUSC/R	50	CDTTUFTSC/R	50
Blue BU	CKT4SPSC/BU	50	CDS6U/SC/BU	50	CDTTUSC/BU	50	CDTTUFTSC/BU	50
Black BL	CKT4SPSC/BL	50	CDS6U/SC/BL	50	CDTTUSC/BL	50	CDTTUFTSC/BL	50
Orange O	CKT4SPSC/O	50	CDS6U/SC/O	50	CDTTUSC/O	50	CDTTUFTSC/O	50
Green G	CKT4SPSC/G	50	CDS6U/SC/G	50	CDTTUSC/G	50	CDTTUFTSC/G	50
Yellow Y	CKT4SPSC/Y	50	CDS6U/SC/Y	50	CDTTUSC/Y	50	CDTTUFTSC/Y	50
White W	CKT4SPSC/W	50	CDS6U/SC/W	50	CDTTUSC/W	50	CDTTUFTSC/W	50

Accessories

	Cat. No.	Std. Pk.	Cat. No.	Std. Pk.	Cat. No.	Std. Pk.	Cat. No.	Std. Pk.	
End Plate	-	-	EPDCS6U	50	EPCDTTU	50	EPCDTTU	50	
DIN Rail	2511120 CA701-15/S 2511160	20 20 10	2511120 CA701-15/S 2511160	20 20 10	2511120 CA701-15/S 2511160	20 20 10	2511120 CA701-15/S 2511160	20 20 10	
End Stop	CA702 CA802 CA202	100 50 50	CA702 CA802 CA202	100 50 50	CA702 CA802 CA202	100 50 50	CA702 CA802 CA202	100 50 50	
Pre Assembled Jumpers	2 pole 3 pole 4 pole 10 pole 100 pole	CA722/2 CA722/3 CA722/4 CA722/10 CA722/100	100 100 100 10 10	CA723/2 CA723/3 CA723/4 CA723/10	100 50 50 10	- - - -	- - - -	- - - -	
Insulated Jumpers	2 pole 3 pole 4 pole 10 pole 100 pole	CA742/2 CA742/3 CA742/4 CA742/10 CA742/100	100 100 100 10 10	- - - - -	- - - - -	- - - - -	- - - - -	- - - - -	
External Jumpers	2 pole 3 pole 4 pole 10 pole	CA714/2 CA714/3 CA714/4 CA714/10	100 100 100 20	- - - -	- - - -	CA710/2 CA710/3 CA710/4 CA710/10	100 50 50 20	CA710/2 CA710/3 CA710/4 CA710/10	100 50 50 20
Shorting Plug	-	-	-	-	QJ8/2	25	-	-	
Marking Tag	MT6	1 Pk. (100 tags)	MT8	1 Pk. (100 tags)	MT8	1 Pk. (100 tags)	MT8	1 Pk. (100 tags)	

HIGHLIGHTS

FEATURES

- Various configurations of Electronic components soldered into **CDL4U** double level terminal block
- Various Diode / Resistor combinations
- 4 connection points for convenient wiring
- Terminal Block with open current bar **CDL4U(O)** can be individually soldered with electronic components
- Spacer **CDL4USP** can be used to cover overlapping components when soldered individually

APPLICATIONS

- Reverse polarity protection
- Lamp testing

CDL4U(E)D1/D2

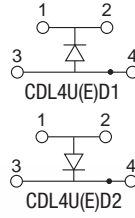

CDL4U(E)D3



CDL4U(E)DD1/DD2

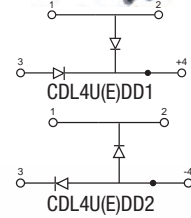

Arc Suppression circuit diode for contactors and solenoid valves

Diode reverse polarity protection

Diode circuit for lamp testing

Dimensions & Weight

Width	6 mm	6 mm	6 mm
Length	55.5 mm	55.5 mm	55.5 mm
Height w DIN Rail	35 x 7.5 mm 35 x 15 mm	55.7 mm 63.1 mm	55.7 mm 63.1 mm
Weight per piece	13.6 g	13.4 g	13.4 g

Technical Data/Ratings

Approvals									
	22-10 AWG	0.2-4 mm ²		22-10 AWG	0.2-4 mm ²		22-10 AWG	0.2-4 mm ²	
Wire Size (solid / stranded)	600 V	300 V	500 V AC	600 V	300 V	500 V AC	600 V	300 V	500 V AC
Voltage Rating	35 A	25 A	32 A	35 A	25 A	32 A	35 A	25 A	32 A
Current Rating	7 lb-in		0.5 Nm	7 lb-in		0.5 Nm	7 lb-in		0.5 Nm
Torque	Polyamide 66			Polyamide 66			Polyamide 66		
Insulation Material	Polyamide 66			Polyamide 66			Polyamide 66		

Electronic Component Specifications

Diode Type	1N 4007			1N 4007			1N 4007		
Diode Reverse Voltage / Current	1000 V / 1 A			1000 V / 1 A			1000 V / 1 A		
Indicator Voltage	-			-			-		

Installation Instructions

Wire Stripping Length	9 mm			9 mm			9 mm		
Screwdriver	Flat Head 0.6 x 3.5 mm			Flat Head 0.6 x 3.5 mm			Flat Head 0.6 x 3.5 mm		

Terminal Blocks

	Cat. No.	Std. Pk.	Cat. No.	Std. Pk.	Cat. No.	Std. Pk.
Grey	CDL4U(E)D1	100	CDL4U(E)D3	100	CDL4U(E)DD1	100
	CDL4U(E)D2	100			CDL4U(E)DD2	100

Accessories

	Cat. No.	Std. Pk.	Cat. No.	Std. Pk.	Cat. No.	Std. Pk.
End Plate	EPCDL4U	50	EPCDL4U	50	EPCDL4U	50
Spacer	CDL4USP	50	CDL4USP	50	CDL4USP	50
DIN Rail	2511120	20	2511120	20	2511120	20
	CA701-15/S	20	CA701-15/S	20	CA701-15/S	20
	2511160	10	2511160	10	2511160	10
End Stop	CA702	50	CA702	50	CA702	50
	CA802	50	CA802	50	CA802	50
Internal Jumper	2 pole	100	CA727/2	100	CA727/2	100
	3 pole	100	CA727/3	100	CA727/3	100
	4 pole	100	CA727/4	100	CA727/4	100
	10 pole	10	CA727/10	10	CA727/10	10
Marking Tag	MT2	1 Pk. (100 tags)	MT2	1 Pk. (100 tags)	MT2	1 Pk. (100 tags)

CDL4U SPACER

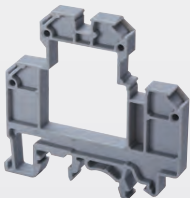

Spacer to cover electronic components which stick out of CDL4U(O)

Cat. No.	Std. Pk.
CDL4USP	50

CDL4U(E)DD3/DD4

CDL4U(E)D4

CDL4U(E)DD5

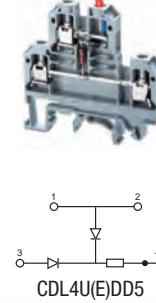
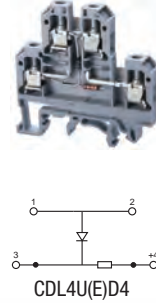
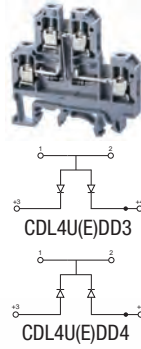

Dimensions & Weight

	Diode circuit for lamp testing	Diode circuit for lamp testing with LED series resistance	Diode circuit for lamp testing with LED series resistance
Width	6 mm	6 mm	6 mm
Length	55.5 mm	55.5 mm	55.5 mm
Height w DIN Rail	35 x 7.5 mm 35 x 15 mm	55.7 mm 63.1 mm	55.7 mm 63.1 mm
Weight per piece	13.6 g	13.6 g	13.6 g

Technical Data/Ratings

Approvals									
Wire Size (solid / stranded)	22-10 AWG			22-10 AWG			22-10 AWG		
Voltage Rating	600 V	300 V	500 V AC	600 V	300 V	500 V AC	600 V	300 V	500 V AC
Current Rating	35 A	25 A	32 A	35 A	25 A	32 A	35 A	25 A	32 A
Torque	7 lb-in		0.5 Nm	7 lb-in		0.5 Nm	7 lb-in		0.5 Nm
Insulation Material	Polyamide 66			Polyamide 66			Polyamide 66		

Electronic Component Specifications

Diode Type	1N 4007	1N 4007	1N 4007
Diode Reverse Voltage / Current	1000 V / 1 A	1000 V / 1 A	1000 V / 1 A
Indicator Voltage	-	-	-

Installation Instructions

Wire Stripping Length	9 mm	9 mm	9 mm
Screwdriver	Flat Head 0.6 x 3.5 mm	Flat Head 0.6 x 3.5 mm	Flat Head 0.6 x 3.5 mm

Terminal Blocks

	Cat. No.	Std. Pk.	Cat. No.	Std. Pk.	Cat. No.	Std. Pk.
Grey	CDL4U(E)DD3	100	CDL4U(E)D4/12V	100	CDL4U(E)DD5/12V	100
	CDL4U(E)DD4	100	CDL4U(E)D4/24V	100	CDL4U(E)DD5/24V	100

Accessories

	Cat. No.	Std. Pk.	Cat. No.	Std. Pk.	Cat. No.	Std. Pk.	
End Plate	EPCDL4U	50	EPCDL4U	50	EPCDL4U	50	
Spacer	CDL4USP	50	CDL4USP	50	CDL4USP	50	
DIN Rail	2511120	20	2511120	20	2511120	20	
	CA701-15/S	20	CA701-15/S	20	CA701-15/S	20	
	2511160	10	2511160	10	2511160	10	
End Stop	CA702	50	CA702	50	CA702	50	
	CA802	50	CA802	50	CA802	50	
Internal Jumper	2 pole	CA727/2	100	CA727/2	100	CA727/2	100
	3 pole	CA727/3	100	CA727/3	100	CA727/3	100
	4 pole	CA727/4	100	CA727/4	100	CA727/4	100
	10 pole	CA727/10	10	CA727/10	10	CA727/10	10
Marking Tag	MT2	1 Pk. (100 tags)	MT2	1 Pk. (100 tags)	MT2	1 Pk. (100 tags)	

HIGHLIGHTS

FEATURES

- Various configurations of Electronic components soldered into **CDL4U** double level terminal block
- Various Indicator options
- AC voltage indicator
- DC voltage indicator
- LED and Neon lamp versions
- 4 connection points for convenient wiring
- Terminal Block with open current bar **CDL4U(O)** can be individually soldered with electronic components
- Spacer **CDL4USP** can be used to cover overlapping components when soldered individually

APPLICATIONS

- AC voltage indication
- DC voltage indication

CDL4U(E)N1

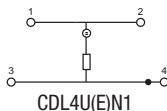

CDL4U(E)LD5

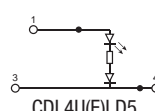

CDL4U(E)LD3

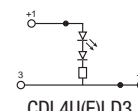

Dimensions & Weight

	AC Voltage indicator with Neon lamp	AC Voltage indicator with LED	AC Voltage indicator with LED
Width	6 mm	6 mm	6 mm
Length	55.5 mm	55.5 mm	55.5 mm
Height w DIN Rail	35 x 7.5 mm 35 x 15 mm	55.7 mm 63.1 mm	55.7 mm 63.1 mm
Weight per piece	13.6 g	12.4 g	12.4 g

Technical Data/Ratings

Approvals									
	Wire Size (solid / stranded)	22-10 AWG	0.2-4 mm ²	22-10 AWG	0.2-4 mm ²	22-10 AWG	0.2-4 mm ²	22-10 AWG	0.2-4 mm ²
Voltage Rating	600 V	300 V	500 V AC	600 V	300 V	500 V AC	600 V	300 V	500 V AC
Current Rating	35 A	25 A	32 A	35 A	25 A	32 A	35 A	25 A	32 A
Torque	7 lb-in		0.5 Nm	7 lb-in		0.5 Nm	7 lb-in		0.5 Nm
Insulation Material	Polyamide 66			Polyamide 66			Polyamide 66		

Electronic Component Specifications

Diode Type	1N 4007	1N 4007	1N 4007
Diode Reverse Voltage / Current	1000 V / 1 A	1000 V / 1 A	1000 V / 1 A
Indicator Voltage	110, 220 VAC	24, 48, 110, 220 VAC	12, 24 VAC

Installation Instructions

Wire Stripping Length	9 mm	9 mm	9 mm
Screwdriver	Flat Head 0.6 x 3.5 mm	Flat Head 0.6 x 3.5 mm	Flat Head 0.6 x 3.5 mm

Terminal Blocks

	Cat. No.	Std. Pk.	Cat. No.	Std. Pk.	Cat. No.	Std. Pk.
Grey	CDL4U(E)N1/110V	100	CDL4U(E)LD5/24V	100	CDL4U(E)LD3/12V	100
	CDL4U(E)N1/220V	100	CDL4U(E)LD5/48V	100	CDL4U(E)LD3/24V	100
			CDL4U(E)LD5/110V	100		
			CDL4U(E)LD5/220V	100		

Accessories

	Cat. No.	Std. Pk.	Cat. No.	Std. Pk.	Cat. No.	Std. Pk.
End Plate	EPCDL4U	50	EPCDL4U	50	EPCDL4U	50
Spacer	CDL4USP	50	CDL4USP	50	CDL4USP	50
DIN Rail	2511120	20	2511120	20	2511120	20
	CA701-15/S	20	CA701-15/S	20	CA701-15/S	20
	2511160	10	2511160	10	2511160	10
End Stop	CA702	50	CA702	50	CA702	50
	CA802	50	CA802	50	CA802	50
Internal Jumper	2 pole CA727/2	100	2 pole CA727/2	100	2 pole CA727/2	100
	3 pole CA727/3	100	3 pole CA727/3	100	3 pole CA727/3	100
	4 pole CA727/4	100	4 pole CA727/4	100	4 pole CA727/4	100
	10 pole CA727/10	10	10 pole CA727/10	10	10 pole CA727/10	10
	Marking Tag	MT2	1 Pk. (100 tags)	MT2	1 Pk. (100 tags)	MT2

CDL4U(E)LD1/LD2

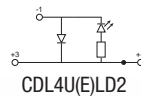
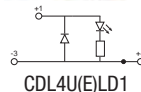

CDL4U(E)LD4

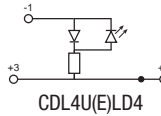

CDL4U(E)L1/L2

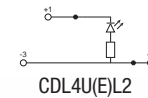
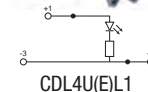

CDL4U(O)

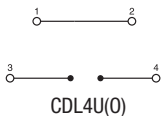

Dimensions & Weight

Width	6 mm	6 mm	6 mm	6 mm
Length	55.5 mm	55.5 mm	55.5 mm	55.5 mm
Height w/ DIN Rail	35 x 7.5 mm 35 x 15 mm	55.7 mm 63.1 mm	55.7 mm 63.1 mm	55.7 mm 63.1 mm
Weight per piece	12.4 g	12.4 g	12.4 g	13.0 g

Technical Data/Ratings

Approvals												
Wire Size (solid / stranded)	22-10 AWG			0.2-4 mm ²			22-10 AWG			0.2-4 mm ²		
Voltage Rating	600 V	300 V	500 V AC	600 V	300 V	500 V AC	600 V	300 V	500 V AC	600 V	300 V	500 V AC
Current Rating	35 A	25 A	32 A	35 A	25 A	32 A	35 A	25 A	32 A	35 A	35 A	32 A
Torque	7 lb-in			0.5 Nm			7 lb-in			0.5 Nm		
Insulation Material	Polyamide 66											

Electronic Component Specifications

Diode Type	1N 4007	1N 4007	1N 4007	1N 4007
Diode Reverse Voltage / Current	1000 V / 1 A	1000 V / 1 A	1000 V / 1 A	1000 V / 1 A
Indicator Voltage	12, 24 VAC	24, 48 VAC	6, 24 VAC	-

Installation Instructions

Wire Stripping Length	9 mm	9 mm	9 mm	9 mm
Screwdriver	Flat Head 0.6 x 3.5 mm	Flat Head 0.6 x 3.5 mm	Flat Head 0.6 x 3.5 mm	Flat Head 0.6 x 3.5 mm

Terminal Blocks

Grey	Cat. No.	Std. Pk.	Cat. No.	Std. Pk.	Cat. No.	Std. Pk.	Cat. No.	Std. Pk.
	CDL4U(E)LD1/12V	100	CDL4U(E)LD4/24V	100	CDL4U(E)L1/6V	100	CDL4U(O)	100
	CDL4U(E)LD1/24V	100	CDL4U(E)LD4/48V	100	CDL4U(E)L1/24V	100		
	CDL4U(E)LD2/12V	100			CDL4U(E)L2/6V	100		
	CDL4U(E)LD2/24V	100			CDL4U(E)L2/24V	100		

Accessories

End Plate	Cat. No.	Std. Pk.	Cat. No.	Std. Pk.	Cat. No.	Std. Pk.	Cat. No.	Std. Pk.
	EPCDL4U	50	EPCDL4U	50	EPCDL4U	50	EPCDL4U	50
Spacer	CDL4USP	50	CDL4USP	50	CDL4USP	50	CDL4USP	50
DIN Rail	2511120	20	2511120	20	2511120	20	2511120	20
	CA701-15/S	20	CA701-15/S	20	CA701-15/S	20	CA701-15/S	20
	2511160	10	2511160	10	2511160	10	2511160	10
End Stop	CA702	50	CA702	50	CA702	50	CA702	50
	CA802	50	CA802	50	CA802	50	CA802	50
Internal Jumper	CA727/2	100	CA727/2	100	CA727/2	100	CA727/2	100
	CA727/3	100	CA727/3	100	CA727/3	100	CA727/3	100
	CA727/4	100	CA727/4	100	CA727/4	100	CA727/4	100
	CA727/10	10	CA727/10	10	CA727/10	10	CA727/10	10
Marking Tag	MT2	1 Pk. (100 tags)	MT2	1 Pk. (100 tags)	MT2	1 Pk. (100 tags)	MT2	1 Pk. (100 tags)

HIGHLIGHTS

FEATURES

- Various solutions to protect single lines against surges
- Lightning Arrestors (**CDL4U(E)LA**)
- MOVs (**CDL4U(E)MOV**)
- RC Circuits (**CDL4U(E)RC**)
- Suppressor Diode (**CDL4U(E)SD**)

APPLICATIONS

- Surge suppressor applications
- Equipment protection

CDL4U(E)LA

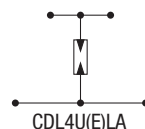

CDL4U(E)3LA

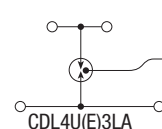

CDL4U(E)RC

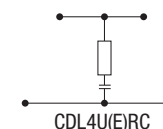

Dimensions & Weight

	CDL4U(E)LA	CDL4U(E)3LA	CDL4U(E)RC
Width	18 mm	18 mm	18 mm
Length	55.5 mm	55.5 mm	55.5 mm
Height w DIN Rail	35 x 7.5 mm 35 x 15 mm	55.7 mm 63.1 mm	55.7 mm 63.1 mm
Weight per piece	30.0 g	34.2 g	22.4 g

Technical Data/Ratings / Component Specifications

	CDL4U(E)LA	CDL4U(E)3LA	CDL4U(E)RC
Wire Size (solid / stranded)	22-10 AWG	22-10 AWG	22-10 AWG
Insulation Material	Polyamide 66	Polyamide 66	Polyamide 66
Nominal Current	10 A	5 A	-
Peak Current	-	-	2kA-6.5kA (8/20μs)
Nominal Discharge Current	20 KA (8/20μs)	10 KA (8/20μs)	-
Response Time	100 ns	100 ns	< 25 ns
Capacitance	< 1.5 pf	< 1.0 pf	100 - 20,000 pf
Voltage Rating	75, 90, 230, 600, 1000 V DC	90, 230, 350, 600 V DC	30, 60, 75, 130, 275, 460, 510, 625, 680 V AC

Installation Instructions

	CDL4U(E)LA	CDL4U(E)3LA	CDL4U(E)RC
Wire Stripping Length	9 mm	9 mm	9 mm
Screwdriver	Flat Head 0.6 x 3.5 mm	Flat Head 0.6 x 3.5 mm	Flat Head 0.6 x 3.5 mm

Terminal Blocks

	Cat. No.	Std. Pk.	Cat. No.	Std. Pk.	Cat. No.	Std. Pk.
Grey	CDL4U(E)LA/75V	20	CDL4U(E)3LA/90V	20	0.1 μF	10
	CDL4U(E)LA/90V	20	CDL4U(E)3LA/230V	20	CDL4U(E)RC0.1	10
	CDL4U(E)LA/230V	20	CDL4U(E)3LA/350V	20	0.22 μF	10
	CDL4U(E)LA/600V	20	CDL4U(E)3LA/600V	20	CDL4U(E)RC0.22	10
	CDL4U(E)LA/1000V	20				

Accessories

	Cat. No.	Std. Pk.	Cat. No.	Std. Pk.	Cat. No.	Std. Pk.
End Plate	EPCDL4U	50	EPCDL4U	50	EPCDL4U	50
Spacer	CDL4USP	50	CDL4USP	50	CDL4USP	50
DIN Rail	2511120	20	2511120	20	2511120	20
	CA701-15/S	20	CA701-15/S	20	CA701-15/S	20
	2511160	10	2511160	10	2511160	10
End Stop	CA702	50	CA702	50	CA702	50
	CA802	50	CA802	50	CA802	50
Marking Tag	MT2	1 Pk. (100 tags)	MT2	1 Pk. (100 tags)	MT2	1 Pk. (100 tags)

CDL4U(E)MOV

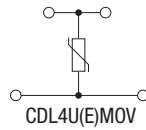

CTLG2.5(E)MOV

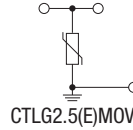

CDL4U(E)SD

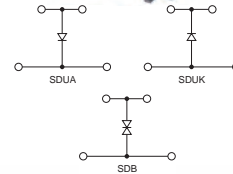

Dimensions & Weight

Width	12 mm	6 mm	12 mm
Length	55.5 mm	87.5 mm	55.5 mm
Height w DIN Rail	35 x 7.5 mm 35 x 15 mm	55.7 mm 63.1 mm	55.7 mm 63.1 mm
Weight per piece	19.2 g	14.8 g	18.0 g

Technical Data/Ratings / Component Specifications

Wire Size (solid / stranded)	22-10 AWG	22-10 AWG	22-10 AWG
Insulation Material	Polyamide 66	Polyamide 66	Polyamide 66
Nominal Current	-	5 A	-
Peak Current	2kA-6.5kA (8/20µs)	2kA-6.5kA (8/20µs)	-
Nominal Discharge Current	-	10 KA (8/20µs)	1.5 KA
Response Time	< 25 ns	< 25 ns	1 ns (D.C) / 5 ns (A.C)
Capacitance	100 - 20,000 pf	100 - 20,000 pf	-
Voltage Rating	30, 60, 75, 130, 275, 460, 510, 625, 680 V AC	Up to 275V	30, 60, 75, 130, 275, 460, 510, 625, 680 V AC

Installation Instructions

Wire Stripping Length	9 mm	9 mm	9 mm
Screwdriver	Flat Head 0.6 x 3.5 mm	Flat Head 0.6 x 3.5 mm	Flat Head 0.6 x 3.5 mm

Terminal Blocks

	Cat. No.	Std. Pk.	Cat. No.	Std. Pk.	Cat. No.	Std. Pk.
Grey	CDL4U(E)MOV30V	20	CTLG2.5(E)MOV30V	20	DC - Anode	
	CDL4U(E)MOV60V	20	CTLG2.5(E)MOV60V	20	CDL4U(E)SDUA12VDC	20
	CDL4U(E)MOV75V	20	CTLG2.5(E)MOV75V	20	CDL4U(E)SDUA24VDC	20
	CDL4U(E)MOV130V	20	CTLG2.5(E)MOV130V	20	CDL4U(E)SDUA48VDC	20
	CDL4U(E)MOV275V	20	CTLG2.5(E)MOV275V	20	DC - Cathode	
	CDL4U(E)MOV460V	20			CDL4U(E)SDUK12VDC	20
	CDL4U(E)MOV510V	20			CDL4U(E)SDUK24VDC	20
	CDL4U(E)MOV625V	20			CDL4U(E)SDUK48VDC	20
	CDL4U(E)MOV680V	20			AC	
					CDL4U(E)SDB12VAC	
				CDL4U(E)SDB24VAC		
				CDL4U(E)SDB48VAC		
				CDL4U(E)SDB160VAC		

Accessories

	Cat. No.	Std. Pk.	Cat. No.	Std. Pk.	Cat. No.	Std. Pk.
End Plate	EPCDL4U	50	EPCTLG2.5	50	EPCDL4U	50
Spacer	CDL4USP	50	-	-	CDL4USP	50
DIN Rail	2511120 CA701-15/S 2511160	20 20 10	2511120 CA701-15/S 2511160	20 20 10	2511120 CA701-15/S 2511160	20 20 10
End Stop	CA702 CA802	50 50	CA702 CA802	50 50	CA702 CA802	50 50
Marking Tag	MT2	1 Pk. (100 tags)	MT2	1 Pk. (100 tags)	MT2	1 Pk. (100 tags)

ACCESSORIES

SCREW TERMINAL BLOCKS

JUMPER / SHORTING LINKS

Internal Jumper



Insulated Internal Jumper



External Jumper



Current Bar



Shorting Sleeve & Screws



	Poles	Cat. No.	Std. Pk.	Cat. No.	Std. Pk.	Cat. No.	Std. Pk.	Cat. No.	Std. Pk.	Cat. No.	Std. Pk.		
CTS2.5U-N	2 Pole	CA721/2	100	CA741/2	100	CA717/2	100	CA703/01	100	CA707/S/Q/01	100		
	3 Pole	CA721/3	100	CA741/3	100	CA717/3	100	CA704/01	100				
	4 Pole	CA721/4	100	CA741/4	100	CA717/4	100	CA705/01	100				
	10 Pole	CA721/10	10	CA741/10	10	CA717/10	20	CA731/10	100				
	100 Pole	CA721/100	10	CA741/100	10	-	-	CA731/100	10				
CTS4U-N, CCC4U, CMC1-2, CMC2-2, CDL4UN, CDL4U(I.S) CDLG4, CDLG(I.S), CF4SP, CF4SP(L), CKT4U¹, CKT4SP	2 Pole	CA722/2	100	CA742/2	100	CA714/2	100	CA703/1	100	CA707/S/Q/01	100		
	3 Pole	CA722/3	100	CA742/3	100	CA714/3	100	CA704/1	100				
	4 Pole	CA722/4	100	CA742/4	100	CA714/4	100	CA705/1	100				
	10 Pole	CA722/10	10	CA742/10	10	CA714/10	20	CA732/10	100				
	100 Pole	CA722/100	10	CA742/100	10	-	-	CA732/100	10				
CTS6U, CDS6U CDTTU¹, CDTTU-SH¹	2 Pole	CA723/2	100	CA743/2	100	CA710/2	100	CA703/2	100	CA707/S/Q/1	100		
	3 Pole	CA723/3	50	CA743/3	50	CA710/3	50	CA704/2	100				
	4 Pole	CA723/4	50	CA743/4	50	CA710/4	50	CA705/2	100				
	10 Pole	CA723/10	10	CA743/10	10	CA710/10	20	CA733/10	10				
	2 Pole	CA724/2	100	CA744/2	100	CA718/2	100	CA703/3	100				
CTS10U	3 Pole	CA724/3	50	CA744/3	50	CA718/3	50	CA704/3	100	CA707/S/Q/1	100		
	4 Pole	CA724/4	50	CA744/4	50	CA718/4	50	CA705/3	100				
	10 Pole	CA724/10	10	CA744/10	10	CA718/10	20	CA734/10	10				
	2 Pole	CA751/2	50	CA761/2	50	-	-	CA703/8	100			CA707/S/Q/1	100
	3 Pole	CA751/3	50	CA761/3	50	-	-	CA704/8	100				
4 Pole	CA751/4	50	CA761/4	50	-	-	CA705/8	100					
10 Pole	CA751/10	10	CA761/10	10	-	-	CA739/10	10					
2 Pole	CA725/2	50	CA745/2	50	-	-	CA703/4	100	CA707/S/Q/2	100			
CTS25UN	3 Pole	CA725/3	20	CA745/3	20	-	-	CA704/4			100		
	4 Pole	CA725/4	20	CA745/4	20	-	-	CA705/4			100		
	10 Pole	CA725/10	10	CA745/10	10	-	-	CA735/10			100		
	2 Pole	CA771/2	50	CA781/2	50	-	-	CA703/10			100	CA707/S/Q/2	100
	CTS35UN	3 Pole	CA771/3	20	CA781/3	20	-	-	CA704/10	100			
4 Pole		CA771/4	20	CA781/4	20	-	-	CA705/10	100				
10 Pole		CA771/10	10	CA781/10	10	-	-	CA770/10	10				
2 Pole		CA628/2	10	-	-	-	-	-	-	-	-		
CTS50/70N		3 Pole	CA628/3	10	-	-	-	-	-	-	-	-	
	2 Pole	CA629/2	10	-	-	-	-	-	-	-	-		
CTS95/120N	3 Pole	CA629/3	10	-	-	-	-	-	-	-	-		
	2 Pole	CA722/2	100	-	-	CA715/2	100	CA703/1	100	CA707/S/Q/01	100		
CTL2.5U, CTL2.5U(L) CTL2.5U-H, CTL2.5U-H(L) CTL2.5U(I.S)	3 Pole	CA722/3	100	-	-	CA715/3	100	CA704/1	100				
	4 Pole	CA722/4	100	-	-	CA715/4	100	CA705/1	100				
	10 Pole	CA722/10	10	-	-	CA715/10	20	CA732/10	100				
	100 Pole ²	CA722/100	10	-	-	-	-	CA732/100	10				
	2 Pole	CA727/2	100	CA747/2	100	CA714/2	100	CA703/1	100	CA607/S/Q	100		
ODL4U CDL4U(E) CMT4 CMB4	3 Pole	CA727/3	100	CA747/3	100	CA714/3	100	CA704/1	100				
	4 Pole	CA727/4	100	CA747/4	100	CA714/4	100	CA705/1	100				
	10 Pole	CA727/10	10	CA747/10	10	CA714/10	20	CA732/10	100				
	100 Pole ²	CA727/100	10	CA747/100	10	-	-	CA732/100	10				
	2 Pole	CA627/2	100	-	-	CA715/2	100	CA703/1	100	CA611/S/Q	100		
CDLG2.5 CTLG2.5	3 Pole	CA627/3	100	-	-	CA715/3	100	CA704/1	100				
	4 Pole	CA627/4	100	-	-	CA715/4	100	CA705/1	100				
	10 Pole	CA627/10	10	-	-	CA715/10	20	CA732/10	10				
	2 Pole	-	-	-	-	CA711/2	100	-	-			-	-
	CF4U¹ CF4U(L)¹	3 Pole	-	-	-	-	CA711/3	50	-	-	-	-	
4 Pole		-	-	-	-	CA711/4	50	-	-	-	-		
10 Pole		-	-	-	-	CA711/10	20	-	-	-	-		
2 Pole		CA729/2	100	CA749/2	100	CA711/2	100	CA703/6	100	CA707/S/Q/3	100		
DDFL4U, DDFL4U(E) DDFL4ULR, DDFL4ULR(E) CSDL4U¹, DDDL4U	3 Pole	CA729/3	50	CA749/3	50	CA711/3	50	CA704/6	100				
	4 Pole	CA729/4	50	CA749/4	50	CA711/4	50	CA705/6	100				
	10 Pole	CA729/10	10	CA749/10	10	CA711/10	20	CA737/10	100				
	2 Pole	-	-	-	-	CA716/2	50	-	-			-	-
	CAFL4U¹ CAFL4U(L)¹ CAFL4U(N)¹	3 Pole	-	-	-	-	CA716/3	50	-	-	-	-	
4 Pole		-	-	-	-	CA716/4	50	-	-	-	-		
10 Pole		-	-	-	-	CA716/10	20	-	-	-	-		
2 Pole		CA623/2	100	-	-	-	-	-	-	-	-		
CHV4U CTS4USC	3 Pole	CA623/3	100	-	-	-	-	-	-	-	-		
	4 Pole	CA623/4	100	-	-	-	-	-	-	-	-		
	10 Pole	CA623/10	10	-	-	-	-	-	-	-	-		
	2 Pole	CA624/2	100	-	-	-	-	-	-	-	-		
CHV6U CTS6USC	3 Pole	CA624/3	100	-	-	-	-	-	-	-	-		
	4 Pole	CA624/4	100	-	-	-	-	-	-	-	-		
	10 Pole	CA624/10	10	-	-	-	-	-	-	-	-		
	2 Pole	CA625/2	100	-	-	-	-	-	-	-	-		
CHV10U CTS10USC	3 Pole	CA625/3	100	-	-	-	-	-	-	-	-		
	4 Pole	CA625/4	100	-	-	-	-	-	-	-	-		
	10 Pole	CA625/10	10	-	-	-	-	-	-	-	-		

¹ Internal shorting system not available.

² 100 pole strip is breakable into any number of poles needed.

VARIOUS ACCESSORIES

ENDPLATES



Terminal Block	Cat. No.	Dimensions	Std. Pk.
CTS2.5U-N, CTS4U-N	EP2.5/4UN	32 x 39 x 1.5mm	50
CTT2.5UK/J/T/E	EP6/10U	31 x 42.5 x 1.5mm	50
CCTS6U, CTS10U	EP6/10U	31 x 42.5 x 1.5mm	50
CMC1-2	EPCMC1-2	35.5 x 46.5 x 2.5mm	50
CMC2-2, CMCG4	EPCMC2-2	40.5 x 65 x 2.5mm	50
CDL4UN, CDLG4	EPCDL4UN	47.5 x 57 x 1.5mm	50
CDLG2.5	EPCDLG2.5	48 x 71.4 x 1.2mm	50
CTLG2.5	EPCTLG2.5	62.5 x 87.5 x 1.2mm	50
ODL4U	EP0DL4U (Front) EP10DL4U (Back)	49 x 86 x 5.5mm 24 x 68 x 3mm	50 50
CHV Series, CTSUSC Series	EPUSC	52 x 48.5 x 1.5mm	50
CTL2.5U Series	EPCTL2.5U	55.5 x 84 x 1.5mm	50
CTL2.5U-H Series	EPCTL2.5U-H	55.5 x 61 x 1.5mm	50
CAFL4U Series	EPCAF4U	32 x 72 x 1.5mm	50
CDS6U	EPCDS6U	37.2 x 82 x 1.5mm	50
CKT4U	EPCKT4U	30.5 x 46.5 x 2.5mm	50
EPCKT4U	EPCKT4U/4	65 x 38.3 x 1.5mm	50
CDTTU Series	EPCDTTU	41 x 63 x 3mm	50
CSDL4U	EPCSFL4U	28 x 55.5 x 1.6mm	50
DDDL4U, DDFL4U	EPDDL4U	49 x 87.6 x 3mm	50
CDL4U(E)	EPCDL4U	43 x 55 x 2.4mm	50
CTC4U	EPCTC4U	34.5 x 47 x 2.5mm	50
CMT4	EPCMT4	23 x 27 x 1.5mm	50
CMB4	EPCMB4	27 x 27 x 7mm	50
ODL2.5 Series	EP0DL2.5 EP10DL2.5	49 x 59 x 4.6mm 23 x 59 x 2.5mm	50 50

PARTITION PLATES

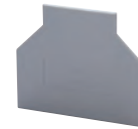

Terminal Block	Cat. No.	Dimensions	Std. Pk.
CTS2.5U-N, CTS4U-N	PP2.5/4UN	37 x 44 x 1.6mm	50
CTT2.5UK/J/T/E	PP6/10U	37.5 x 56 x 1.5mm	50
CTS6U, CTS10U	PP6/10U	37.5 x 56 x 1.5mm	50
CTS25UN	PP25UN	42.5 x 62 x 1mm	50
CTS35UN	PP35UN	50 x 64.5 x 1mm	50
CMT4	PPCMT4	32 x 37 x 1.6mm	50

SEPARATOR PLATES



Terminal Block	Cat. No.	Dimensions	Std. Pk.
CTS2.5U-N, CTS4U-N	SP2.5/4UN	17.5 x 17.4 x 1.4mm	100
CTT2.5UK/J/T/E	SP6/10U	15.4 x 16.2 x 1.5mm	100
CTS6U, CTS10U, CTS16U	SP6/10U	15.4 x 16.2 x 1.5mm	100
CSL4UN, CDL4UN(I.S.)	SPCDL4U	15.4 x 16.2 x 1.6mm	100
CBM4	SPCMB4	14.5 x 12 x 1.5mm	100
CDLG2.5	SPCDLG2.5	11 x 10.5 x 1	100

END STOPS

CA202

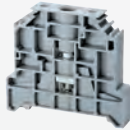

Cat. No.	Dimensions	Std. Pk.
CA202	44.5 x 50 x 9.5mm	50

CA802

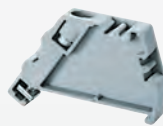

Cat. No.	Dimensions	Std. Pk.
CA802	45 x 32 x 8mm	50

CA702



Cat. No.	Dimensions	Std. Pk.
CA702	34 x 45 x 9mm	50

CA102

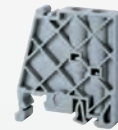

Cat. No.	Dimensions	Std. Pk.
CA102	80 x 46 x 9mm	50

PROTECTIVE COVER

CTSPC COVER

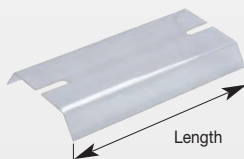

Cat. No.	Length	Std. Pk.
CTSPC/40	40mm	2
CTSPC/90	90mm	2
CTSPC/100	100mm	2
CTSPC/130	130mm	2
CTSPC/150	150mm	2
CTSPC/200	200mm	2
CTSPC/300	300mm	2
CTSPC/330	330mm	2

SUPPORT PLATE



Cat. No.	Std. Pk.
CSP1	50

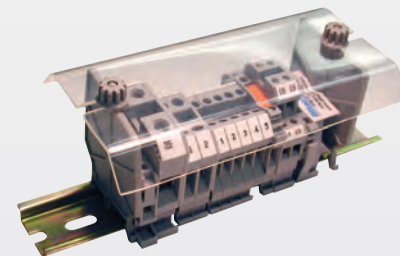

Assembled Block installed with Protective Cover

LUG/ STUD TYPE CONNECTION TECHNOLOGY

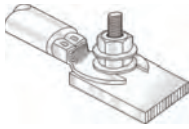

- Accepts Ring/ Fork Lug Cable Lugs
- Withstands severe vibration
- Reliable Gas-tight connection
- For very large wire sizes (up to 350 kcmil)
- High Torque values
- Secure connection
- Hinged cover featuring captive nut system guarantees quick and easy ring lug wiring



MATERIAL SPECIFICATIONS

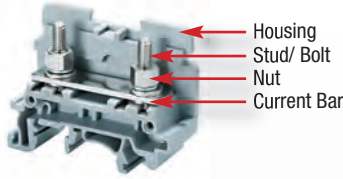

Current Carrying Metal

Corrosion free material

- Bolt: zinc chromate passivated steel
- Nut/ Screw: zinc chromate passivated steel
- Current Bar: nickel plated copper alloy/ tin plated copper

Terminal Block Housing

- Polyamide PA66 Housing
- Self-extinguishing
- High mechanical strength

Polyamide 66 Specifications

- Upper Temperature Limit: 105°C
- Lower Temperature Limit: -50°C
- Flammability UL94: V2/ V0
- Volume Resistivity: $10^{12} \Omega \text{ cm}$
- Surface Resistivity: $10^{10} \Omega$

INSTALLATION GUIDELINES



- 1 Remove screw/ nut by using wrench/ hex nut driver
- 2 Place cable with ring/ fork cable lug on stud
- 3 Tighten screw/ nut to specified torque by using wrench/hex nut driver

RING LUG TERMINAL CONNECTION TYPES AND FEATURES

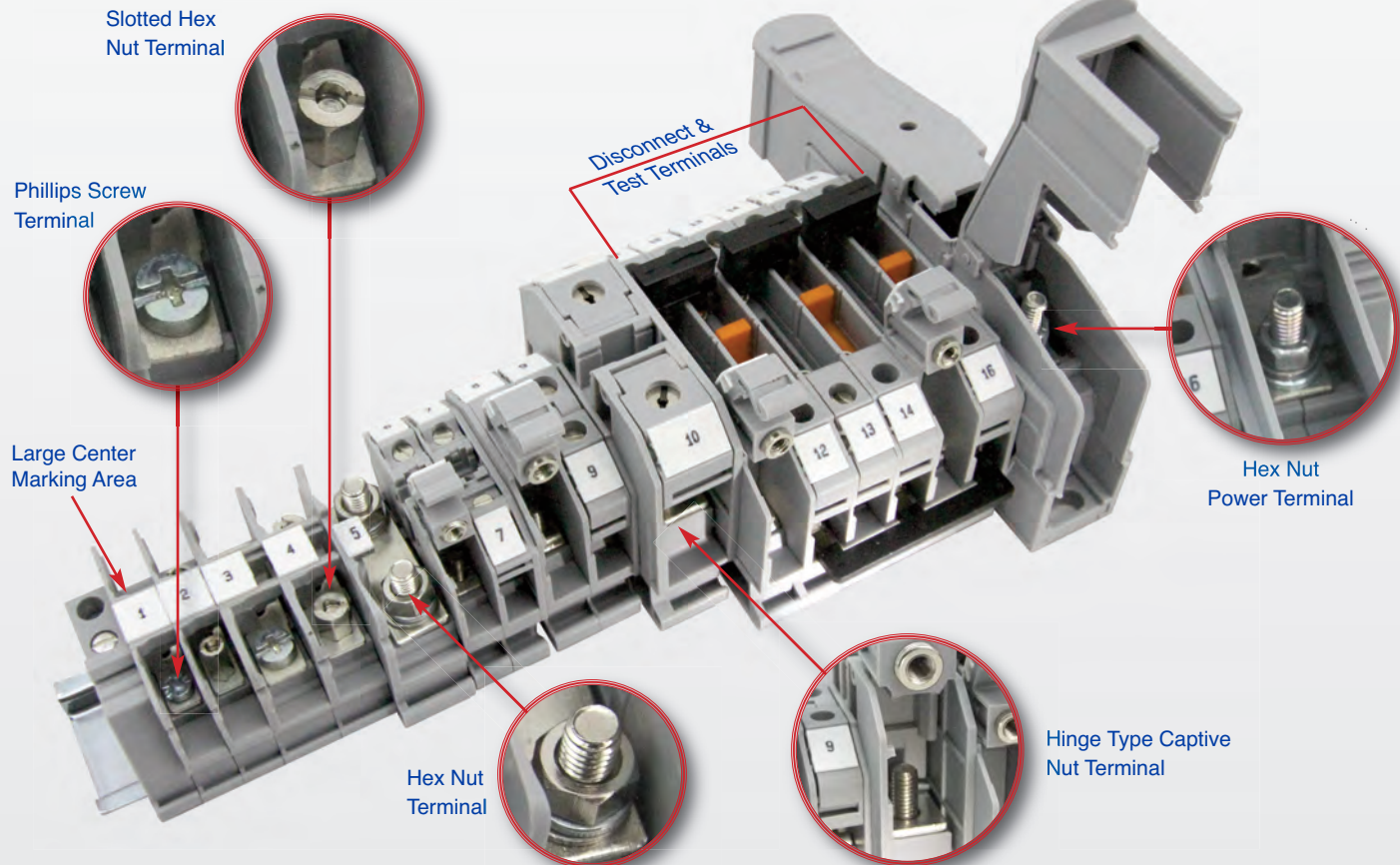

Ring Lug Barrier Terminal Blocks

FEATURES

- Phillips Screw (CBS Series)
- Slotted Hex Nut (CSB Series)
- 22-4 AWG
- Up to 85A

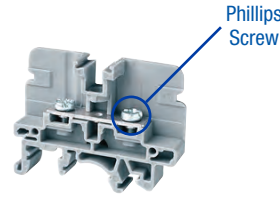

CBS Series
page 52

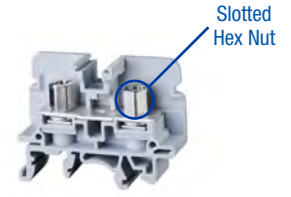

CSB Series
page 53

Ring Lug Stud Terminal Blocks

FEATURES

- Hex Nut (CSTSN Series)
- Slotted Hex Nut (CSTSB Series)
- 22-2 AWG
- Up to 125A

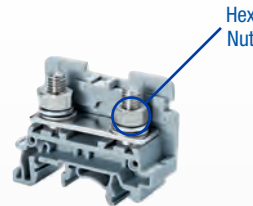

CSTSN Series
page 54

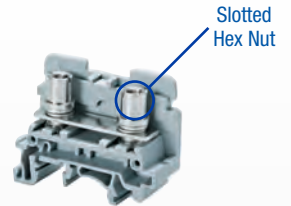

CSTSB Series
page 55

Ring Lug Hinge Terminal Blocks

FEATURES

- Captive Nut Built-In Hinge
- Feed-Through Terminals
- Disconnect Terminals
- 22-2 AWG
- Up to 115A



Feed-Through
page 56



Disconnect
page 57

Ring Lug Power Terminal Blocks

FEATURES

- Nut/Bolt Connection
- Threaded Current Bar
- 10 AWG - 350 kcmil
- up to 310A



CBB Series
page 58-59

High Current Power Terminal Blocks

FEATURES

- Captive Bolt System
- 8-4/0 AWG
- Up to 230A
- Protective Cover
- Stackable

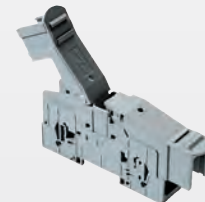

PTB Series
page 60

Accessories



page 61

HIGHLIGHTS

FEATURES

- Various sizes
 - Wire size up to 4 AWG
 - Current rating up to 85 A
- Suitable for standard fork type / ring lug connectors
- Version with standard Phillips Screw (**CBS Series**)
- Version with slotted nut (**CSB Series**)
- Compact design
- 2, 3, 4 pole fork type and ring lug jumpers

APPLICATIONS

- Applications with vibration
 - Machinery
 - Transportation
 - Vehicles
- Provides solution when ring / fork lug is needed
- Compact / Space saving Panels

CBS3U



CBS4U



CBS5U

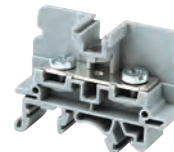

Dimensions & Weight

	50 A Ring Lug Terminal Phillips Screw Head	65 A Ring Lug Terminal Phillips Screw Head	85 A Ring Lug Terminal Phillips Screw Head
Width	9 mm	13 mm	13 mm
Length	49 mm	49 mm	49 mm
Height w DIN Rail 35 x 7.5 mm 35 x 15 mm	38 mm 45.5 mm	38 mm 45.5 mm	38 mm 45.5 mm
Weight per piece	7.4 g	12.4 g	13.8 g

Technical Data/Ratings

Approvals						
	22-8 AWG	0.5-6 mm ²	16-6 AWG	1.5-10 mm ²	16-4 AWG	1.5-16 mm ²
Wire Size (solid / stranded)						
Voltage Rating	600 V	1000V AC/DC	600 V	1000V AC/DC	600 V	1000V AC/DC
Current Rating	50 A	41 A	65 A	57 A	85 A	76 A
Torque	4.5 lb-in	0.5 Nm	10 lb-in	1.2 Nm	25 lb-in	2.0 Nm
Insulation Material	Polyamide 66		Polyamide 66		Polyamide 66	

Installation Instructions

Wire Stripping Length	—		—		—	
Screw / Stud Size	M3		M4		M5	
Screwdriver	Phillips #2		Phillips #2		Phillips #2	

Terminal Blocks

	Cat. No.	Std. Pk.	Cat. No.	Std. Pk.	Cat. No.	Std. Pk.
Grey (standard)	CBS3U	50	CBS4U	50	CBS5U	50
Red R	CBS3U/R	50	CBS4U/R	50	CBS5U/R	50
Blue BU	CBS3U/BU	50	CBS4U/BU	50	CBS5U/BU	50
Black BL	CBS3U/BL	50	CBS4U/BL	50	CBS5U/BL	50
Orange O	CBS3U/O	50	CBS4U/O	50	CBS5U/O	50
Green G	CBS3U/G	50	CBS4U/G	50	CBS5U/G	50
Yellow Y	CBS3U/Y	50	CBS4U/Y	50	CBS5U/Y	50
White W	CBS3U/W	50	CBS4U/W	50	CBS5U/W	50

Accessories

	Cat. No.	Std. Pk.	Cat. No.	Std. Pk.	Cat. No.	Std. Pk.
End Plate	EPCBS3U	50	EPCBS3U	50	EPCBS3U	50
DIN Rail	2511120 CA701-15/S 2511160	20 20 10	2511120 CA701-15/S 2511160	20 20 10	2511120 CA701-15/S 2511160	20 20 10
End Stop	CA802	50	CA802	50	CA802	50
Insulated Jumper Fork Type	CA514/15-2 CA514/15-3 CA514/15-4	100 50 50	CA514/2-2 CA514/2-3 CA514/2-4	100 50 50	CA514/2-2 CA514/2-3 CA514/2-4	100 50 50
Insulated Jumper Ring Lug	CA514/17-2 CA514/17-3 CA514/17-4	100 50 50	CA514/4-2 CA514/4-3 CA514/4-4	100 50 50	CA514/4-2 CA514/4-3 CA514/4-4	100 50 50
Internal Jumper	CA728/2 CA728/3 CA728/4 CA728/10	100 100 100 10	CA772/2 CA772/3 CA772/4 CA772/10	100 100 100 10	CA772/2 CA772/3 CA772/4 CA772/10	100 100 100 10
Protective Cover	— CSTSPC2 CSTSPC2-1 CSTSPC1-2 CSTSPC1-3 CSTSPC1-4	— 10 10 10 10 10	— CSTSPC2 CSTSPC2-1 CSTSPC1-2 CSTSPC1-3 CSTSPC1-4	10 10 10 10 10 10	— CSTSPC2 CSTSPC2-1 CSTSPC1-2 CSTSPC1-3 CSTSPC1-4	10 10 10 10 10 10
Marking Tag	MT9	1 Pk. (100 tags)	MT9	1 Pk. (100 tags)	MT9	1 Pk. (100 tags)

CSB3/N3U



CSB3/N3UL



CSB4/N4U



CSB5/N5U



Dimensions & Weight

	50 A Ring Lug Terminal Slotted Hex Nut	50 A Ring Lug Terminal Long Slotted Hex Nut	65 A Ring Lug Terminal Slotted Hex Nut	85 A Ring Lug Terminal Slotted Hex Nut
Width	9 mm	9 mm	13 mm	13 mm
Length	49 mm	49 mm	49 mm	49 mm
Height w/ DIN Rail	35 x 7.5 mm 35 x 15 mm	38 mm 45.5 mm	38 mm 45.5 mm	38 mm 45.5 mm
Weight per piece	10.2 g	11.7 g	19.0 g	19.0 g

Technical Data/Ratings

Approvals								
Wire Size (solid / stranded)	22-8 AWG	0.5-6 mm ²	22-8 AWG	0.5-6 mm ²	16-6 AWG	1.5-10 mm ²	16-4 AWG	1.5-16 mm ²
Voltage Rating	600 V	1000V AC/DC	600 V	1000V AC/DC	600 V	1000V AC/DC	600 V	1000V AC/DC
Current Rating	50 A	41 A	50 A	41 A	65 A	57 A	85 A	76 A
Torque	4.5 lb-in	0.5 Nm	4.5 lb-in	0.5 Nm	10 lb-in	1.2 Nm	25 lb-in	2.0 Nm
Insulation Material	Polyamide 66		Polyamide 66		Polyamide 66		Polyamide 66	

Installation Instructions

Wire Stripping Length	—	—	—	—
Screw / Stud Size	M3	M3	M4	M5
Screwdriver	Hex Nut Driver 7 mm	Flat Head 1.0 x 5.5 mm	Flat Head 1.0 x 5.5 mm	Flat Head 1.0 x 5.5 mm

Terminal Blocks

	Cat. No.	Std. Pk.	Cat. No.	Std. Pk.	Cat. No.	Std. Pk.	Cat. No.	Std. Pk.
Grey (standard)	CSB3/N3U	50	CSB3/N3UL	50	CSB4/N4U	50	CSB5/N5U	50
Red R	CSB3/N3U/R	50	CSB3/N3UL/R	50	CSB4/N4U/R	50	CSB5/N5U/R	50
Blue BU	CSB3/N3U/BU	50	CSB3/N3UL/BU	50	CSB4/N4U/BU	50	CSB5/N5U/BU	50
Black BL	CSB3/N3U/BL	50	CSB3/N3UL/BL	50	CSB4/N4U/BL	50	CSB5/N5U/BL	50
Orange O	CSB3/N3U/O	50	CSB3/N3UL/O	50	CSB4/N4U/O	50	CSB5/N5U/O	50
Green G	CSB3/N3U/G	50	CSB3/N3UL/G	50	CSB4/N4U/G	50	CSB5/N5U/G	50
Yellow Y	CSB3/N3U/Y	50	CSB3/N3UL/Y	50	CSB4/N4U/Y	50	CSB5/N5U/Y	50
White W	CSB3/N3U/W	50	CSB3/N3UL/W	50	CSB4/N4U/W	50	CSB5/N5U/W	50

Accessories

	Cat. No.	Std. Pk.	Cat. No.	Std. Pk.	Cat. No.	Std. Pk.	Cat. No.	Std. Pk.
End Plate	EPCBS3U	50	EPCBS3U	50	EPCBS3U	50	EPCBS3U	50
DIN Rail	2511120 CA701-15/S 2511160	20 20 10	2511120 CA701-15/S 2511160	20 20 10	2511120 CA701-15/S 2511160	20 20 10	2511120 CA701-15/S 2511160	20 20 10
End Stop	CA802	50	CA802	50	CA802	50	CA802	50
Insulated Jumper Fork Type	CA514/15-2 CA514/15-3 CA514/15-4	100 50 50	CA514/15-2 CA514/15-3 CA514/15-4	100 50 50	CA514/2-2 CA514/2-3 CA514/2-4	100 50 50	CA514/2-2 CA514/2-3 CA514/2-4	100 50 50
Insulated Jumper Ring Lug	CA514/17-2 CA514/17-3 CA514/17-4	100 50 50	CA514/17-2 CA514/17-3 CA514/17-4	100 50 50	CA514/4-2 CA514/4-3 CA514/4-4	100 50 50	CA514/4-2 CA514/4-3 CA514/4-4	100 50 50
Internal Jumper	CA728/2 CA728/3 CA728/4 CA728/10	100 100 100 10	CA728/2 CA728/3 CA728/4 CA728/10	100 100 100 10	CA772/2 CA772/3 CA772/4 CA772/10	100 100 100 10	CA772/2 CA772/3 CA772/4 CA772/10	100 100 100 10
Protective Cover	— CSTSPC2 CSTSPC2-1 CSTSPC1-2 CSTSPC1-3 CSTSPC1-4	— 10 10 10 10 10	— CSTSPC2 CSTSPC2-1 CSTSPC1-2 CSTSPC1-3 CSTSPC1-4	— 10 10 10 10 10	CSTSPC2 CSTSPC2-1 — CSTSPC1-2 CSTSPC1-3 CSTSPC1-4	10 10 — 10 10 10	CSTSPC2 CSTSPC2-1 — CSTSPC1-2 CSTSPC1-3 CSTSPC1-4	10 10 — 10 10 10
Marking Tag	MT9	1 Pk. (100 tags)	MT9	1 Pk. (100 tags)	MT9	1 Pk. (100 tags)	MT9	1 Pk. (100 tags)

CSTSN SERIES

STUD / RING LUG TERMINALS

STUD TYPE RING LUG TERMINAL BLOCKS

HIGHLIGHTS

FEATURES

- Various sizes
 - Wire size up to 2 AWG
 - Current rating up to 125 A
- Suitable for standard fork type / ring lug connectors
- Version with standard Hex Nut (**CSTSN Series**)
- Version with slotted barrel (**CSTSB Series**)
- Compact design
- 2, 3, 4 pole fork type and ring lug jumpers

APPLICATIONS

- Applications with vibration
 - Machinery
 - Transportation
 - Vehicles
- Provides solution when ring / fork lug is needed
- Compact / Space saving Panels

CSTSN4U



CSTSN5U



CSTSN6U



Dimensions & Weight

	65 A Bolt Terminal M4 Hex Nut	80 A Bolt Terminal M5 Hex Nut	125 A Bolt Terminal M6 Hex Nut
Width	17 mm	17 mm	17 mm
Length	50 mm	50 mm	50 mm
Height w DIN Rail	35 x 7.5 mm 35 x 15 mm	40.7 mm 48.0 mm	40.7 mm 48.0 mm
Weight per piece	21.5 g	23.4 g	30.4 g

Technical Data/Ratings

Approvals						
Wire Size (solid / stranded)	22-6 AWG	1.5-10 mm ²	22-4 AWG	1.5-16 mm ²	22-2 AWG	1.5-35 mm ²
Voltage Rating	600 V	1000V AC/DC	600 V	1000V AC/DC	600 V	1000V AC/DC
Current Rating	65 A	57 A	80 A	76 A	125 A	125 A
Torque	14 lb-in	1.2 Nm	25 lb-in	2.0 Nm	25 lb-in	3.0 Nm
Insulation Material	Polyamide 66		Polyamide 66		Polyamide 66	

Installation Instructions

Wire Stripping Length	—	—	—
Screw / Stud Size	M4	M5	M6
Screwdriver	Hex Nut Driver 7 mm	Hex Nut Driver 8 mm	Hex Nut Driver 9 mm

Terminal Blocks

	Cat. No.	Std. Pk.	Cat. No.	Std. Pk.	Cat. No.	Std. Pk.
Grey (standard)	CSTSN4U	100	CSTSN5U	100	CSTSN6U	100
Red R	CSTSN4U/R	100	CSTSN5U/R	100	CSTSN6U/R	100
Blue BU	CSTSN4U/BU	100	CSTSN5U/BU	100	CSTSN6U/BU	100
Black BL	CSTSN4U/BL	100	CSTSN5U/BL	100	CSTSN6U/BL	100
Orange O	CSTSN4U/O	100	CSTSN5U/O	100	CSTSN6U/O	100
Green G	CSTSN4U/G	100	CSTSN5U/G	100	CSTSN6U/G	100
Yellow Y	CSTSN4U/Y	100	CSTSN5U/Y	100	CSTSN6U/Y	100
White W	CSTSN4U/W	100	CSTSN5U/W	100	CSTSN6U/W	100

Accessories

	Cat. No.	Std. Pk.	Cat. No.	Std. Pk.	Cat. No.	Std. Pk.
End Plate	EPCSTSU	50	EPCSTSU	50	EPCSTSU	50
DIN Rail	2511120	20	2511120	20	2511120	20
	CA701-15/S	20	CA701-15/S	20	CA701-15/S	20
	2511160	10	2511160	10	2511160	10
End Stop	CA802	50	CA802	50	CA802	50
Insulated Jumper Fork Type	2 pole CA514/1-2	100	2 pole CA514/1-2	100	2 pole CA514/7-2	100
	3 pole CA514/1-3	50	3 pole CA514/1-3	50	3 pole CA514/7-3	50
	4 pole CA514/1-4	50	4 pole CA514/1-4	50	4 pole CA514/7-4	50
Jumper Ring Lug	2 pole CA514/3-2	100	2 pole CA514/3-2	100	2 pole CA514/8-2	100
	3 pole CA514/3-3	50	3 pole CA514/3-3	50	3 pole CA514/8-3	50
	4 pole CA514/3-4	50	4 pole CA514/3-4	50	4 pole CA514/8-4	50
Protective Cover	2 Terminal CSTSPC2	10	2 Terminal CSTSPC2	10	2 Terminal CSTSPC2	10
	3 Terminal CSTSPC2-1	10	3 Terminal CSTSPC2-1	10	3 Terminal CSTSPC2-1	10
	4 Terminal —	—	4 Terminal —	—	4 Terminal —	—
	100 mm CSTSPC1-2	10	100 mm CSTSPC1-2	10	100 mm CSTSPC1-2	10
	200 mm CSTSPC1-3	10	200 mm CSTSPC1-3	10	200 mm CSTSPC1-3	10
	300 mm CSTSPC1-4	10	300 mm CSTSPC1-4	10	300 mm CSTSPC1-4	10
Marking Tag	MT2B4	1 Pk. (100 tags)	MT2B4	1 Pk. (100 tags)	MT2B4	1 Pk. (100 tags)

CSTSB4U



CSTSB5U



Dimensions & Weight

	CSTSB4U	CSTSB5U
Width	17 mm	17 mm
Length	50 mm	50 mm
Height w DIN Rail	35 x 7.5 mm 35 x 15 mm	40.7 mm 48.0 mm
Weight per piece	24 g	25.5 g

Technical Data/Ratings

Approvals				
Wire Size (solid / stranded)	22-6 AWG	1.5-10 mm ²	22-4 AWG	1.5-16 mm ²
Voltage Rating	600 V	1000V AC/DC	600 V	1000V AC/DC
Current Rating	65 A	57 A	80 A	76 A
Torque	14 lb-in	1.2 Nm	25 lb-in	2.0 Nm
Insulation Material	Polyamide 66		Polyamide 66	

Installation Instructions

Wire Stripping Length	—	
Screw / Stud Size	M4	M5
Screwdriver	Flat Head 1.0 x 5.5 mm	

Terminal Blocks

	Cat. No.	Std. Pk.	Cat. No.	Std. Pk.
Grey (standard)	CSTSB4U	100	CSTSB5U	100
Red R	CSTSB4U/R	100	CSTSB5U/R	100
Blue BU	CSTSB4U/BU	100	CSTSB5U/BU	100
Black BL	CSTSB4U/BL	100	CSTSB5U/BL	100
Orange O	CSTSB4U/O	100	CSTSB5U/O	100
Green G	CSTSB4U/G	100	CSTSB5U/G	100
Yellow Y	CSTSB4U/Y	100	CSTSB5U/Y	100
White W	CSTSB4U/W	100	CSTSB5U/W	100

Accessories

	Cat. No.	Std. Pk.	Cat. No.	Std. Pk.
End Plate	EPCSTSU	50	EPCSTSU	50
DIN Rail	2511120	20	2511120	20
	CA701-15/S	20	CA701-15/S	20
	2511160	10	2511160	10
End Stop	CA802	50	CA802	50
Insulated Jumper Fork Type	CA514/1-2	100	CA514/1-2	100
	CA514/1-3	50	CA514/1-3	50
	CA514/1-4	50	CA514/1-4	50
Insulated Jumper Ring Lug	CA514/3-2	100	CA514/3-2	100
	CA514/3-3	50	CA514/3-3	50
	CA514/3-4	50	CA514/3-4	50
Protective Cover	CSTSPC2	10	CSTSPC2	10
	CSTSPC2-1	10	CSTSPC2-1	10
	—	—	—	—
	CSTSPC1-2	10	CSTSPC1-2	10
	CSTSPC1-3	10	CSTSPC1-3	10
	CSTSPC1-4	10	CSTSPC1-4	10
Marking Tag	MT2B4	1 Pk. (100 tags)	MT2B4	1 Pk. (100 tags)

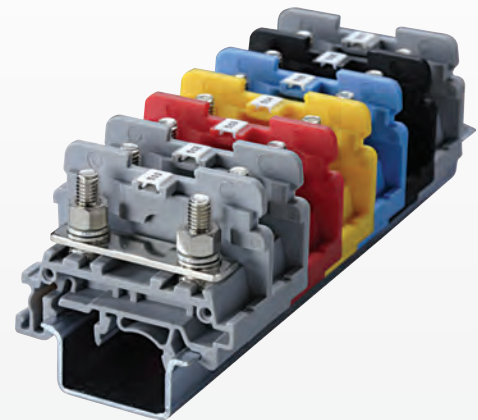

STH SERIES

STUD / RING LUG TERMINALS

HINGE TYPE RING LUG TERMINAL BLOCKS

HIGHLIGHTS

FEATURES

- Bolt Feed Through Terminals
- Suitable for standard fork type / ring lugs
- Captive nut system
- Only standard flat head screw driver needed to tighten connection
- IP20 touch proof terminals with hinged plastic cover
- 2, 3, 4 pole fork type and ring lug jumpers

APPLICATIONS

- Applications with vibration
 - Machinery
 - Transportation
 - Vehicles
- Provides solution when ring / fork lug is needed



Dimensions & Weight

	9 mm	11 mm	18 mm
Width	9 mm	11 mm	18 mm
Length	47 mm	46 mm	64 mm
Height w DIN Rail	35 x 7.5 mm 35 x 15 mm	47.3 mm 54.8 mm	52.2 mm 59.0 mm
Weight per piece	15.0 g	62.5 g	57.8 g

Technical Data/Ratings

Approvals						
Wire Size (solid / stranded)	22-8 AWG	1.5-6 mm ²	22-8 AWG	1.5-6 mm ²	22-2 AWG	1.5-35 mm ²
Voltage Rating	600 V	1000V AC/DC	600 V	1000V AC/DC	600 V	1000V AC/DC
Current Rating	50 A	41 A	50 A	41 A	115 A	125 A
Torque	4.5 lb-in	0.5 Nm	14 lb-in	1.2 Nm	25 lb-in	3.0 Nm
Insulation Material	Polyamide 66		Polyamide 66		Polyamide 66	

Installation Instructions

Wire Stripping Length	—	—	—
Screw / Stud Size	M3	M4	M6
Screwdriver	Flat Head 0.8 x 4 mm	Flat Head 0.8 x 4 mm	Flat Head 1.0 x 5.5 mm

Terminal Blocks

	Cat. No.	Std. Pk.	Cat. No.	Std. Pk.	Cat. No.	Std. Pk.
Grey (standard)	STH3	100	STH4	50	STH6	50
Red R	STH3/R	100	STH4/R	50	STH6/R	50
Blue BU	STH3/BU	100	STH4/BU	50	STH6/BU	50
Black BL	STH3/BL	100	STH4/BL	50	STH6/BL	50
Orange O	STH3/O	100	STH4/O	50	STH6/O	50
Green G	STH3/G	100	STH4/G	50	STH6/G	50
Yellow Y	STH3/Y	100	STH4/Y	50	STH6/Y	50
White W	STH3/W	100	STH4/W	50	STH6/W	50

Accessories

	Cat. No.	Std. Pk.	Cat. No.	Std. Pk.	Cat. No.	Std. Pk.
End Plate	EPSTH3	50	EPSTH4	50	EPSTH6	50
DIN Rail	2511120	20	2511120	20	2511120	20
	CA701-15/S	20	CA701-15/S	20	CA701-15/S	20
	2511160	10	2511160	10	2511160	10
End Stop	CA702	100	CA702	100	CA702	100
	CA802	50	CA802	50	CA802	50
	CA202	50	CA202	50	CA202	50
Jumpers Fork Type	CA512/15-2	100	CA512/13-2	100	—	—
	CA512/15-3	50	CA512/13-3	50	—	—
	CA512/15-4	50	CA512/13-4	50	—	—
Insulated Jumpers Fork Type	CA514/15-2	100	CA514/13-2	100	—	—
	CA514/15-3	50	CA514/13-3	50	—	—
	CA514/15-4	50	CA514/13-4	50	—	—
Jumpers Ring Lug	CA512/17-2	100	CA512/14-2	100	—	—
	CA512/17-3	50	CA512/14-3	50	—	—
	CA512/17-4	50	CA512/14-4	50	—	—
Insulated Jumpers Ring Lug	CA514/17-2	100	CA514/14-2	100	—	—
	CA514/17-3	50	CA514/14-3	50	—	—
	CA514/17-4	50	CA514/14-4	50	—	—
Internal Jumpers	CA773/2	100	—	—	CA774/2	100
	CA773/3	50	—	—	CA774/3	50
	CA773/4	50	—	—	CA774/4	50
	CA773/10	10	—	—	—	—
Marking Tag	MT8	1 Pk. (100 tags)	MT10	1 Pk. (100 tags)	MT16	1 Pk. (100 tags)

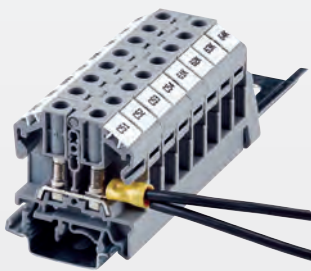
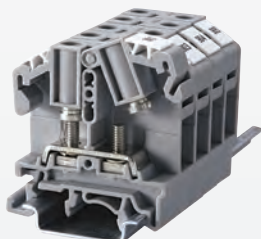

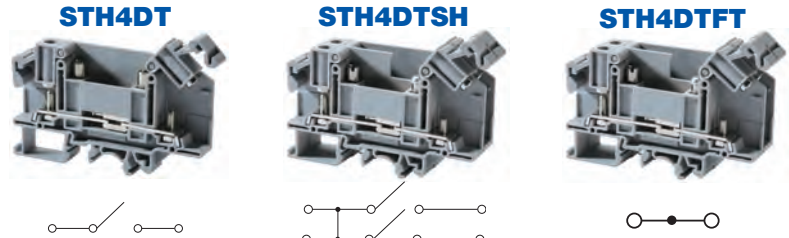

Dimensions & Weight

	STH4DT Disconnect Terminal Block Hinge Type	STH4DTSH Double Disconnect Terminal Block	STH4DTFT Feed-Through Terminal Block Disconnect Profile
Width	11 mm	22 mm	11 mm
Length	86 mm	86 mm	86 mm
Height w DIN Rail	35 x 7.5 mm 35 x 15 mm	52.2 mm 59.0 mm	52.2 mm 59.0 mm
Weight per piece	42.8 g	42.3 g	36.6 g

Technical Data/Ratings

Approvals						
Wire Size (solid / stranded)	22-8 AWG	1.5-6 mm ²	22-8 AWG	1.5-6 mm ²	22-8 AWG	1.5-6 mm ²
Voltage Rating	600 V	1000V AC/DC	300 V	1000V AC/DC	600 V	1000V AC/DC
Current Rating	35 A	41 A	25 A	34 A	50 A	41 A
Torque	14 lb-in	1.2 Nm	14 lb-in	1.2 Nm	14 lb-in	1.2 Nm
Insulation Material	Polyamide 66		Polyamide 66		Polyamide 66	

Installation Instructions

Wire Stripping Length	-		-		-	
Screw / Stud Size	M4		M4		M4	
Screwdriver	Flat Head 0.8 x 4 mm		Flat Head 0.8 x 4 mm		Flat Head 0.8 x 4 mm	

Terminal Blocks

	Cat. No.	Std. Pk.	Cat. No.	Std. Pk.	Cat. No.	Std. Pk.
Grey	STH4DT	50	STH4DTSH	24	STH4DTFT	100

Accessories

	Cat. No.	Std. Pk.	Cat. No.	Std. Pk.	Cat. No.	Std. Pk.	
End Plate	EPSTH4DT	50	EPSTH4DT	50	EPSTH4DT	50	
DIN Rail	2511120 CA701-15/S 2511160	20 20 10	2511120 CA701-15/S 2511160	20 20 10	2511120 CA701-15/S 2511160	20 20 10	
End Stop	CA702 CA802 CA202	100 50 50	CA702 CA802 CA202	100 50 50	CA702 CA802 CA202	100 50 50	
Jumpers Fork Type	2 pole 3 pole 4 pole	CA512/13-2 CA512/13-3 CA512/13-4	100 50 50	CA512/13-2 CA512/13-3 CA512/13-4	100 50 50	CA512/13-2 CA512/13-3 CA512/13-4	100 50 50
Insulated Jumpers Fork Type	2 pole 3 pole 4 pole	CA514/13-2 CA514/13-3 CA514/13-4	100 50 50	CA514/13-2 CA514/13-3 CA514/13-4	100 50 50	CA514/13-2 CA514/13-3 CA514/13-4	100 50 50
Jumpers Ring Lug	2 pole 3 pole 4 pole	CA512/14-2 CA512/14-3 CA512/14-4	100 50 50	CA512/14-2 CA512/14-3 CA512/14-4	100 50 50	CA512/14-2 CA512/14-3 CA512/14-4	100 50 50
Insulated Jumpers Ring Lug	2 pole 3 pole 4 pole	CA514/14-2 CA514/14-3 CA514/14-4	100 50 50	CA514/14-2 CA514/14-3 CA514/14-4	100 50 50	CA514/14-2 CA514/14-3 CA514/14-4	100 50 50
Insulated Alternate Jumpers	3 pole 4 pole	CA514/14-3A CA514/14-4A	10 10	CA514/14-3A CA514/14-4A	10 10	CA514/14-3A CA514/14-4A	10 10
Shorting Plug	QJ11/2	25	QJ11/2	25	-	-	
Lock Out Cap	LCSTH4DT	25	LCSTH4DT	25	-	-	
Marking Tag	MT10	1 Pk. (100 tags)	MT10	1 Pk. (100 tags)	MT10	1 Pk. (100 tags)	

HIGHLIGHTS

FEATURES

- Bolt Disconnect Terminals
- Disconnect (**STH4DT**)
- 2 Shorted Disconnect Terminals (**STH4DTSH**)
- Feed-Through with same profile (**STH4DTFT**)
- Suitable for standard fork type / ring lugs
- Captive nut system
- IP20 touch proof terminals with hinged plastic cover
- 2, 3, 4 pole fork type and ring lug jumpers

APPLICATIONS

- Disconnect / Test Applications
- Measuring / Control Circuit
- Utility Instruments and Transformer Applications
- Meter Replacement
- External Current Measurement

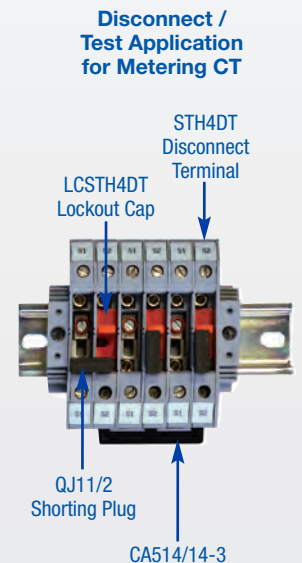

CBB SERIES

STUD / RING LUG TERMINALS

RING LUG POWER TERMINAL BLOCKS

HIGHLIGHTS

FEATURES

- High Current up to 310A
- Feed-Through Terminals
 - Nut / Bolt version
 - Version with threaded current bar (LS) for fast wiring without 2 wrenches
- Wire crimped into ring / fork lug on to the flat current bar
- Special Mounting foot design for tight fit on rail
- Protective Cover in various length
- 2, 3 pole jumper bars

APPLICATIONS

- High Current Power Applications
- Large size wires
- Power Distribution Feeding Applications
- Provides solution when ring / fork lug is needed

CBB35/50 CBB35/50LS



CBB70 CBB70LS



CBB95 CBB95LS



Dimensions & Weight

	150 A Feed Through Power Terminal	175 A Feed Through Power Terminal	230 A Feed Through Power Terminal
Width	32 mm	38 mm	38 mm
Length	75 mm	92 mm	92 mm
Height w DIN Rail	35 x 7.5 mm 35 x 15 mm	47.5 mm 54.5 mm	47.5 mm 54.5 mm
Weight per piece	82.0 g	157.5 g	193.0 g

Technical Data/Ratings

Approvals						
Wire Size (solid / stranded)	10-1/0 AWG / 6-50.0 mm ²		8-2/0 AWG / 6-70.0 mm ²		8-4/0 AWG / 16-95.0 mm ²	
Voltage Rating	600 V / 1000V AC/DC		600 V / 1000V AC/DC		600 V / 1000V AC/DC	
Current Rating	150 A / 150 A		175 A / 192 A		230 A / 232 A	
Torque	27 lb-in / 3.0Nm		54.5 lb-in / 6.0 Nm		90 lb-in / 10.0 Nm	
Insulation Material	Polyamide 66					

Installation Instructions

Wire Stripping Length	—		—		—	
Screw / Stud Size	M6		M8		M10	
Screwdriver						

Terminal Blocks

	Cat. No.	Std. Pk.	Cat. No.	Std. Pk.	Cat. No.	Std. Pk.
Grey Nut & Bolt configuration Threaded Current Bar	CBB35/50	10	CBB70	10	CBB95	10
	CBB35/50LS	10	CBB70LS	10	CBB95LS	10

Accessories

	Cat. No.	Std. Pk.	Cat. No.	Std. Pk.	Cat. No.	Std. Pk.	
Partition Plate	PPCBB	50	PPCBB	50	PPCBB1	50	
DIN Rail	2511120 CA701-15/S	20 20	2511120 CA701-15/S	20 20	2511120 CA701-15/S	20 20	
End Stop	CA102 CA202	50 50	CA102 CA202	50 50	CA102 CA202	50 50	
Protective Cover for installing on PPCBB & PPCBB1	70 mm 80 mm 100 mm 130 mm 160 mm 200 mm 250 mm	CBBPC1/70 CBBPC1/80 CTSPC2-1 CBBPC1/130 CBBPC1/160 CBBPC1/200 CBBPC1/250	10 10 10 10 10 10 10	CBBPC1/70 CBBPC1/80 CTSPC2-1 CBBPC1/130 CBBPC1/160 CBBPC1/200 CBBPC1/250	10 10 10 10 10 10 10	— — CBBPC2/100 — CBBPC2/160 CBBPC2/200 CBBPC2/250	— — 10 — 10 10 10
Permanent Jumper Bars	2 pole 3 pole	CA790/2 CA790/3	10 10	CA791/2 CA791/3	10 10	CA791/2 CA791/3	10 10
Marking Tag	MT12	1 Pk. (100 tags)	MT16	1 Pk. (100 tags)	MT16	1 Pk. (100 tags)	

**CBB120
CBB120LS**

**CBB150
CBB150LS**

**CBB185
CBB185LS**



Dimensions & Weight

	255 A Feed Through Power Terminal	285 A Feed Through Power Terminal	310 A Feed Through Power Terminal
Width	48 mm	48 mm	48 mm
Length	100 mm	110 mm	110 mm
Height w DIN Rail 35 x 7.5 mm 35 x 15 mm	47.3 mm 54.5 mm	47.3 mm 54.5 mm	47.3 mm 54.5 mm
Weight per piece	244.0 g	316.0 g	319.4 g

Technical Data/Ratings

Approvals						
Wire Size (solid / stranded)	8-250 KCMIL	16-120 mm ²	8-300 KCMIL	16-150 mm ²	8-350 KCMIL	16-185 mm ²
Voltage Rating	600 V	1000V AC/DC	600 V	1000V AC/DC	600 V	1000V AC/DC
Current Rating	255 A	269 A	285 A	309 A	310 A	353 A
Torque	90 lb-in	10.0 Nm	127 lb-in	14.0 Nm	127 lb-in	14.0 Nm
Insulation Material	Polyamide 66		Polyamide 66		Polyamide 66	

Installation Instructions

Wire Stripping Length	—	—	—
Screw / Stud Size	M10	M12	M12
Screwdriver	Wrench M10 Flat Head 1 x 1.5 mm	Wrench M12 Flat Head 1 x 1.5 mm	Wrench M12 Flat Head 1 x 1.5 mm

Terminal Blocks

	Cat. No.	Std. Pk.	Cat. No.	Std. Pk.	Cat. No.	Std. Pk.
Grey						
Nut & Bolt configuration	CBB120	10	CBB150	10	CBB185	10
Threaded Current Bar	CBB120LS	10	CBB150LS	10	CBB185LS	10

Accessories

	Cat. No.	Std. Pk.	Cat. No.	Std. Pk.	Cat. No.	Std. Pk.
Partition Plate	PPCBB1	50	PPCBB1	50	PPCBB1	50
DIN Rail	2511120 CA701-15/S	20 20	2511120 CA701-15/S	20 20	2511120 CA701-15/S	20 20
End Stop	CA102 CA202	50 50	CA102 CA202	50 50	CA102 CA202	50 50
Protective Cover	100 mm 160 mm 200 mm 250 mm	CBBPC2/100 CBBPC2/160 CBBPC2/200 CBBPC2/250	10 10 10 10	CBBPC2/100 CBBPC2/160 CBBPC2/200 CBBPC2/250	10 10 10 10	CBBPC2/100 CBBPC2/160 CBBPC2/200 CBBPC2/250
Permanent Jumper Bars	2 pole 3 pole	CA793/2 CA793/3	10 10	CA794/2 CA794/3	10 10	CA794/2 CA794/3
Marking Tag	MT16	1 Pk. (100 tags)	MT16	1 Pk. (100 tags)	MT16	1 Pk. (100 tags)

PTB SERIES

STUD / RING LUG TERMINALS

HIGH CURRENT POWER TERMINAL BLOCKS

HIGHLIGHTS

FEATURES

- Panel / DIN Rail mountable
- High Current up to 230A
- Finger safe protective cover (PSPTBXX)
- Modular / stackable design
- 2, 3, 4 pole jumper system

APPLICATIONS

- High Current Power Applications
- Large size wires
- Power Distribution Feeding Applications
- Provides solution when ring / fork lug is needed

PTB35/50 PTB35/50SH

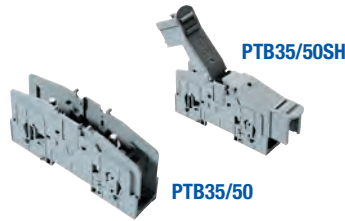

PTB70/95 PTB70/95SH

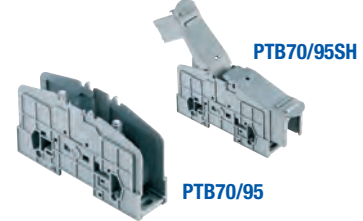

Dimensions & Weight

	25 mm	32 mm
Width	25 mm	32 mm
Length	113 / 169 mm	130 / 192 mm
Height w DIN Rail	61.0 / 66.5 mm 35 x 7.5 mm 35 x 15 mm	76.6 / 78.0 mm 84.5 / 86.0 mm
Weight per piece	112.0 / 130.5 g	174.4 / 198.2 g

Technical Data/Ratings

Approvals				
Wire Size (solid / stranded)	8-2 AWG	1.5-50 mm ²	8-4/0 AWG	1.5-95 mm ²
Voltage Rating	600 V	1000V AC/DC	600 V	1000V AC/DC
Current Rating	115 A	150 A	230 A	232 A
Torque	27 lb-in	3.0 Nm	87 lb-in	10.0 Nm
Insulation Material	Polyamide 66		Polyamide 66	

Installation Instructions

Wire Stripping Length	—	—
Screw / Stud Size	M6	M8
Screwdriver	Hex Nut Driver 10 mm	Hex Nut Driver 13 mm

Terminal Blocks

	Cat. No.	Std. Pk.	Cat. No.	Std. Pk.
Grey	PTB35/50	10	PTB70/95	10
	PTB35/50SH	10	PTB70/95SH	10

Accessories

	Cat. No.	Std. Pk.	Cat. No.	Std. Pk.
Protective Cover	PSPTB35	20	PSPTB70	10
DIN Rail	2511120 CA701-15/S	20 20	2511120 CA701-15/S	20 20
End Stop	CA102 CA202	50 50	CA102 CA202	50 50
Jumper System 2 pole 3 pole 4 pole	CA703/9 CA704/9 CA705/9	10 10 10	CA703/11 CA704/11 CA705/11	10 10 10
Marking Tag	MT9	1 Pk. (100 tags)	MT9	1 Pk. (100 tags)
Marking Tag Holder	MHPTB35		MHPTB35	

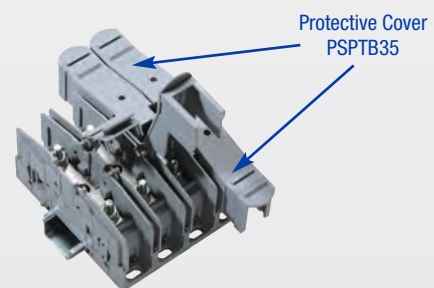
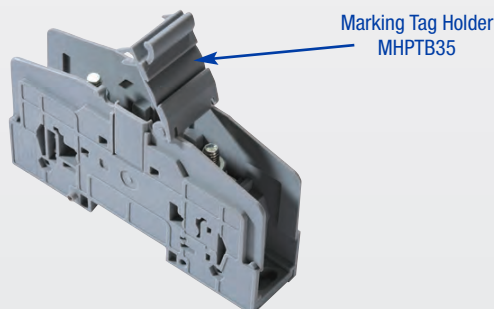



Terminal Block Series	Poles	Fork Type Jumper		Insulated Fork Type Jumper		Ring Lug Jumper		Insulated Ring Lug Jumper		Internal Jumper		Alternate Jumper for STH4DT Series	
		Cat. No.	Std. Pk.	Cat. No.	Std. Pk.	Cat. No.	Std. Pk.	Cat. No.	Std. Pk.	Cat. No.	Std. Pk.	Cat. No.	Std. Pk.
CBS3U	2 Pole	CA512/15-2	100	CA514/15-2	100	CA512/17-2	100	CA514/17-2	100	CA728/2	50		
CSB3/N3U	3 Pole	CA512/15-3	50	CA514/15-3	50	CA512/17-3	50	CA514/17-3	50	CA728/3	50		N/A
CSB3/N3UL	4 Pole	CA512/15-4	50	CA514/15-4	50	CA512/17-4	50	CA514/17-4	50	CA728/4	50		N/A
STH3	10 Pole									CA728/10	10		
CBS4U	2 Pole	CA512/2-2	100	CA514/2-2	100	CA512/4-2	100	CA514/4-2	100	CA772/2	100		
CBS5U	3 Pole	CA512/2-3	50	CA514/2-3	50	CA512/4-3	50	CA514/4-3	50	CA772/3	50		N/A
CSB4/N4UL	4 Pole	CA512/2-4	50	CA514/2-4	50	CA512/4-4	50	CA514/4-4	50	CA772/4	50		N/A
CSB5/N5U	10 Pole									CA772/10	10		
CSTSN4U	2 Pole	CA512/1-2	100	CA514/1-2	100	CA512/3-2	100	CA514/3-2	100				N/A
CSTSN5U	3 Pole	CA512/1-3	50	CA514/1-3	50	CA512/3-3	50	CA514/3-3	50				N/A
CSTSN6U	4 Pole	CA512/1-4	50	CA514/1-4	50	CA512/3-4	50	CA514/3-4	50				N/A
CSTSB4U	4 Pole												
CSTSB5U													
CSTSN6U	2 Pole	CA512/7-2	100	CA514/7-2	100	CA512/8-2	100	CA514/8-2	100				N/A
	3 Pole	CA512/7-3	50	CA514/7-3	50	CA512/8-3	50	CA514/8-3	50				N/A
	4 Pole	CA512/7-4	50	CA514/7-4	50	CA512/8-4	50	CA514/8-4	50				N/A
STH4	2 Pole	CA512/13-2	100	CA514/13-2	100	CA512/14-2	100	CA514/14-2	100				
STH4DT	3 Pole	CA512/13-3	50	CA514/13-3	50	CA512/14-3	50	CA514/14-3	50				N/A
STH4DTFT	4 Pole	CA512/13-4	50	CA514/13-4	50	CA512/14-4	50	CA514/14-4	50				CA514/14-3A 10 CA514/14-4A 10
STH6	2 Pole									CA774/2	100		
	3 Pole	N/A		N/A		N/A		N/A		CA774/3	50		
	4 Pole									CA774/4	50		

END STOPS



Cat. No	Dimensions	Std. Pk.	Cat. No	Dimensions	Std. Pk.	Cat. No	Dimensions	Std. Pk.
CA802	32 x 45 x 8 mm	50	CA702	34 x 45 x 9 mm	50	CA202	44.5 x 50 x 9.5 mm	50

ENDPLATES / PROTECTIVE COVERS



Terminal Block	Cat. No	Dimensions	Std. Pk.
CBS Series	EPCBS3U	26.2 x 49 x 1.5 mm	50
CSB Series			
CSTSN Series	EPCSTSU	31 x 50 x 1.5 mm	50
CSTSB Series			
STH3	EPSTH3	34 x 47 x 1.5 mm	50
STH4	EPSTH4	39.5 x 46 x 1.5 mm	50
STH6	EPSTH6	51 x 63.5 x 1.5 mm	50
STH4DT	EPSTH4DT	37.5 x 86 x 1.5 mm	50

For CBS, CSB, CSTS Series

Length	Cat. No.	Std. Pk.
100mm	CSTSPC1-2	10
200mm	CSTSPC1-3	10
300mm	CSTSPC1-4	10

SPRING CLAMP TECHNOLOGY



- Easy Installation
- Versatile and Vibration Proof
- Reliable Gas-tight connection
- Fail proof, safe connection
- NO torque requirements
- Maintenance free
- Terminals accept wires with/ without ferrules



MATERIAL SPECIFICATIONS

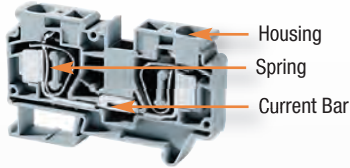

Housing
Spring
Current Bar

Current Carrying Metal *Corrosion free material*

- Spring: Stainless Steel
- Current Bar: copper tin plated

Terminal Block Housing

- Polyamide PA66 Housing
- Self-extinguishing
- High mechanical strength

Polyamide 66 Specifications

Upper Temperature Limit: 105°C
Lower Temperature Limit: -50°C
Flammability UL94: V2/V0
Volume Resistivity: $10^{12} \Omega \text{ cm}$
Surface Resistivity: $10^{10} \Omega$

INSTALLATION GUIDELINES

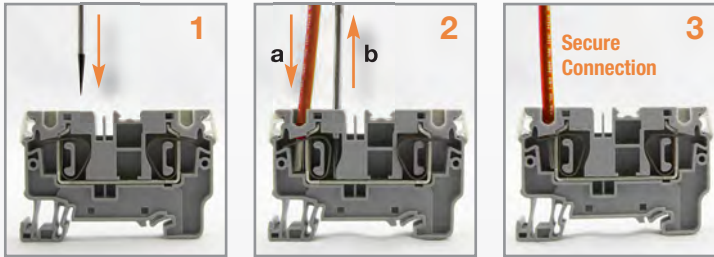

- 1 Insert Flat-Head Screw Driver into insertion space to open pre-loaded spring
- 2 (a) Insert Wire into opening in spring leg. (b) Remove screwdriver.
- 3 The spring force presses conductor against the current bar for a reliable/safe connection



CX SERIES FEATURES AND ADVANTAGES

COMPACT DESIGN

**CX4 - MOST COMPACT
IN THE INDUSTRY**

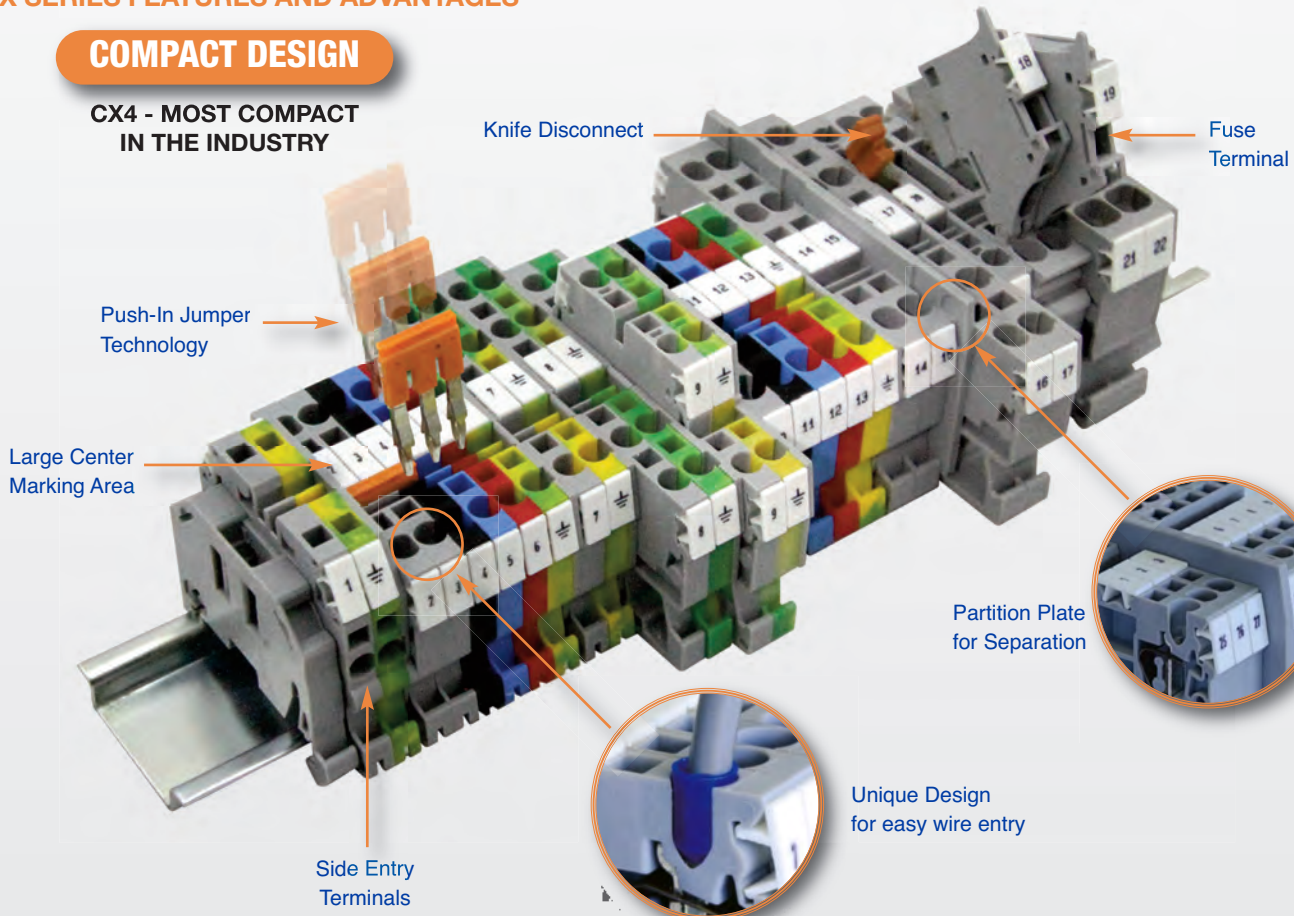

CX Series

FEATURES

- Extremely Compact Design
- CX4 is the most compact in the industry
- Push-In technology jumper system
 - 2, 3, 4 5, 6, 7, 8, 10 pole
 - 2 independent jumper channels
 - Easy breakout of jumper pins for alternate shorting of terminal blocks
 - Felt tip pen marking option
- Center marking tag area
- Unique design in plastic housing for easy wire entry
- Individually mountable partition plates provide electrical and visual separation
- Test Plugs for Test & Measurement needs

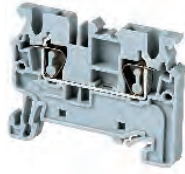

Feed-Through
page 64-65

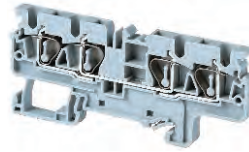

Multi-Connection
page 66-67

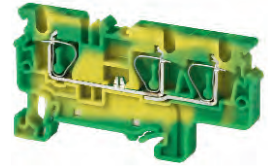

Ground/Earth
page 68-70

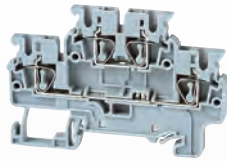

Double Level
page 71

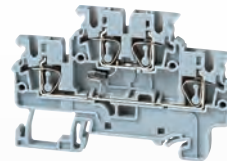

Electronic Component
page 72



Fuse
page 74



Component Carrier
page 75

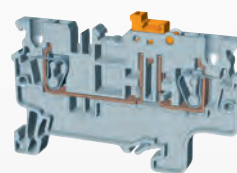

Disconnect
page 76



Side Entry
page 77



Pluggable
page 78



Hybrid Distribution
page 79

Angular Series

FEATURES

- 45 wire entry for easy installation
- 2.5mm to 8mm terminal blocks (up to 50A)
- Multi-Connection Terminals
- 2, 3, 4 connection ground terminals



Feed-Through
page 80



Multi-Connection
page 81



Multi-Level
page 82-83

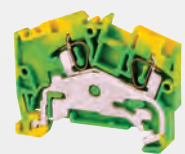

Ground/Earth
page 84-85

Accessories



Jumpers
page 86

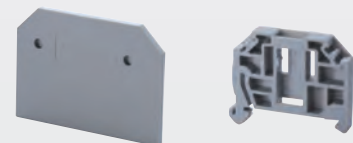

**End Plates, Partitions,
End Stops, Test Plugs**
page 87

CX SERIES

SPRING TERMINAL BLOCKS

FEED THROUGH TERMINAL BLOCKS

HIGHLIGHTS

FEATURES

- Most compact in Industry
- 2, 3, 4, 10 Pole Push-In Jumpers
- 2 Jumper Channels for multiple Jumper options
- 3 and 4 Connection Terminals
- 3 Marking Locations
- Many Colors

APPLICATIONS

- High Vibration Environments
- Machines
- Elevator Cabinets
- Transport

CX2.5

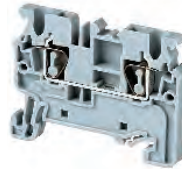

CX4

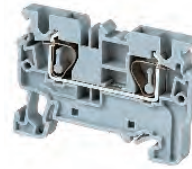

CX6

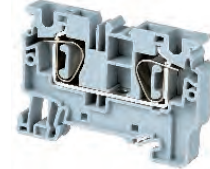

Dimensions

	CX2.5	CX4	CX6
	2 Connection Feed-Through 2 Jumper Channels	2 Connection Feed-Through 2 Jumper Channels	2 Connection Feed-Through 2 Jumper Channels
Width	5 mm	6 mm	8 mm
Length	49.7 mm	54.8 mm	62.1 mm
Height w DIN Rail	35 x 7.5 mm 35 x 15 mm	38.0 mm 45.5 mm	43.0 mm 50.5 mm
Weight per piece	6.2 g	9.8 g	14.0 g

Technical Data/Ratings

Approvals						
Wire Size (solid / stranded)	24-12 AWG	0.2-2.5 mm ²	24-10 AWG	0.2-4 mm ²	24-8 AWG	0.2-6 mm ²
Voltage Rating	600 V	1000V AC/DC	600 V	1000V AC/DC	600 V	1000V AC/DC
Current Rating	20 A	24 A	30 A	32 A	50 A	41 A
Insulation Material	Polyamide 66		Polyamide 66		Polyamide 66	

Installation Instructions

Wire Stripping Length	10 mm	10 mm	14 mm
Screwdriver	Flat Head 0.5 x 3 mm	Flat Head 0.6 x 3.5 mm	Flat Head 0.8 x 4 mm

Terminal Blocks

	Cat. No.	Std. Pk.	Cat. No.	Std. Pk.	Cat. No.	Std. Pk.
Grey (standard)						
Red R	CX2.5/R	100	CX4/R	100	CX6/R	100
Blue BU	CX2.5/BU	100	CX4/BU	100	CX6/BU	100
Black BL	CX2.5/BL	100	CX4/BL	100	CX6/BL	100
Orange O	CX2.5/O	100	CX4/O	100	CX6/O	100
Green G	CX2.5/G	100	CX4/G	100	CX6/G	100
Yellow Y	CX2.5/Y	100	CX4/Y	100	CX6/Y	100
White W	CX2.5/W	100	CX4/W	100	CX6/W	100

Accessories

	Cat. No.	Std. Pk.	Cat. No.	Std. Pk.	Cat. No.	Std. Pk.	
End Plate	EPCX2.5	50	EPCX4	50	EPCX6	50	
Partition Plate	PPCX4	20	PPCX4	20	PPCX10	20	
DIN Rail	2511120 CA701-15/S	20 20	2511120 CA701-15/S	20 20	2511120 CA701-15/S	20 20	
End Stop	CA702 CA802 CA103	50 50 50	CA702 CA802 CA103	50 50 50	CA702 CA802 CA103	50 50 50	
Shorting Link/ Jumpers	2 pole 3 pole 4 pole 5 pole 6 pole 7 pole 8 pole 10 pole 16 pole	JX2.5/2 JX2.5/3 JX2.5/4 JX2.5/5 JX2.5/6 JX2.5/7 JX2.5/8 JX2.5/10 -	100 50 50 50 10 10 10 10 -	JX4/2 JX4/3 JX4/4 - - - JX4/8 JX4/10 JX4/16	100 50 50 50 - - 50 10 10	JX6/2 JX6/3 JX6/4 - - - - JX6/10 -	100 50 50 - - - - 10 -
Test Plug	TX2.5	50	TX4	50	TX6	50	
Marking Tag	MT5	1 Pk. (100 tags)	MT6	1 Pk. (100 tags)	MT8	1 Pk. (100 tags)	
Warning Label	W LX2.5	1 Pk. (100 tags)	W LX4	1 Pk. (100 tags)	W LX6	1 Pk. (100 tags)	

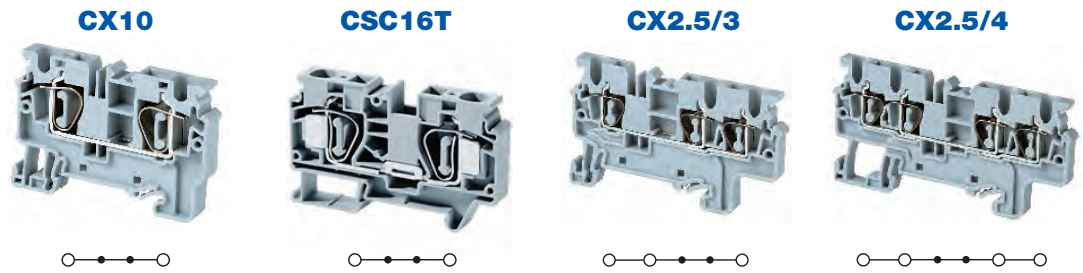

Dimensions

	CX10	CSC16T	CX2.5/3	CX2.5/4
	2 Connection Feed-Through 2 Jump Channels	2 Connection Feed-Through 2 Jump Channels	3 Connection Feed-Through 2 Jump Channels	4 Connection Feed-Through 2 Jumper Channels
Width	10 mm	12 mm	5 mm	5 mm
Length	71.7 mm	82.0 mm	62.2 mm	74.7 mm
Height w DIN Rail	35 x 7.5 mm 35 x 15 mm	49.5 mm 57.0 mm	51.6 mm 59.0 mm	38.0 mm 45.5 mm
Weight per piece	22.4 g	39 g	7.6 g	9.4 g

Technical Data/Ratings

Approvals								
Wire Size (solid stranded)	24-6 AWG	0.2-10 mm ²	16-4 AWG	1.5-16 mm ²	24-12 AWG	0.2-2.5 mm ²	24-12 AWG	0.2-2.5 mm ²
Voltage Rating	600 V	1000V AC/DC	600 V	800V AC/DC	600 V	1000 V AC/DC	600 V	1000V AC/DC
Current Rating	65 A	57 A	85 A	76 A	20 A	24 A	20 A	24 A
Insulation Material	Polyamide 66		Polyamide 66		Polyamide 66		Polyamide 66	

Installation Instructions

Wire Stripping Length	18 mm	20 mm	10 mm	10 mm
Screwdriver	Flat Head 0.8 x 4 mm	Flat Head 1.0 x 5.5 mm	Flat Head 0.5 x 3 mm	Flat Head 0.5 x 3 mm

Terminal Blocks

	Cat. No.	Std. Pk.	Cat. No.	Std. Pk.	Cat. No.	Std. Pk.	Cat. No.	Std. Pk.
Grey (standard)	CX10	50	CSC16T	50	CX2.5/3	100	CX2.5/4	50
Red R	CX10/R	50	CSC16T/R	50	CX2.5/3/R	100	CX2.5/4/R	50
Blue BU	CX10/BU	50	CSC16T/BU	50	CX2.5/3/BU	100	CX2.5/4/BU	50
Black BL	CX10/BL	50	CSC16T/BL	50	CX2.53/BL	100	CX2.5/4/BL	50
Orange O	CX10/O	50	CSC16T/O	50	CX2.5/3/O	100	CX2.5/4/O	50
Green G	CX10/G	50	CSC16T/G	50	CX2.5/3/G	100	CX2.5/4/G	50
Yellow Y	CX10/Y	50	CSC16T/Y	50	CX2.5/3/Y	100	CX2.5/4/Y	50
White W	CX10/W	50	CSC16T/W	50	CX2.53/W	100	CX2.5/4/W	50

Accessories

	Cat. No.	Std. Pk.	Cat. No.	Std. Pk.	Cat. No.	Std. Pk.	Cat. No.	Std. Pk.
End Plate	EPCX10	20	EPCSC16T	50	EPCX2.5/3	50	EPCX2.5/4	20
Partition Plate	PPCX10	20	-	-	PPCX4/3	20	PPCX4/4	20
DIN Rail	2511120 CA701-15/S	20 20	2511120 CA701-15/S	20 20	2511120 CA701-15/S	20 20	2511120 CA701-15/S	20 20
End Stop	CA702 CA802 CA103	50 50 50	CA702 CA802 CA103	50 50 50	CA702 CA802 CA103	50 50 50	CA702 CA802 CA103	50 50 50
Shorting Link/ Jumpers	2 pole JX10/2 3 pole - 4 pole - 5 pole - 6 pole - 7 pole - 8 pole - 10 pole - 16 pole -	20 - - - - - - - -	CA801/5 - - - - - - - -	100 - - - - - - - -	JX2.5/2 JX2.5/3 JX2.5/4 JX2.5/5 JX2.5/6 JX2.5/7 JX2.5/8 JX2.5/10 -	100 50 50 50 10 10 10 10 -	JX2.5/2 JX2.5/3 JX2.5/4 JX2.5/5 JX2.5/6 JX2.5/7 JX2.5/8 JX2.5/10 -	100 50 50 50 10 10 10 10 -
Test Plug	TX10	50	-	-	TX2.5	50	TX2.5	50
Marking Tag Warning Label	MT10 WLX10	1 Pk. (100 tags) 100	-	-	MT5 WLX2.5	1 Pk. (100 tags) 100	MT5 WLX2.5	1 Pk. (100 tags) 100

CX SERIES

SPRING TERMINAL BLOCKS

MULTIPLE CONNECTION TERMINAL BLOCKS

CX4/3

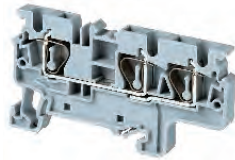

CX4/4

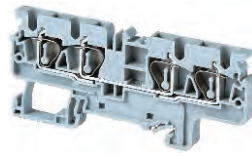

CX6/3

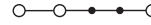
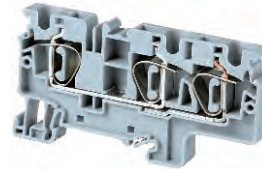

CX10/3

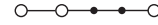
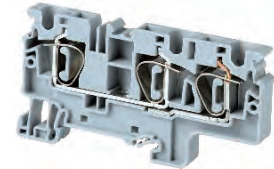

Dimensions

	CX4/3	CX4/4	CX6/3	CX10/3
	3 Connection Feed-Through 2 Jumper Channels	4 Connection Feed-Through 2 Jumper Channels	3 Connection Feed-Through 2 Jumper Channels	4 Connection Feed-Through 2 Jumper Channels
Width	6 mm	6 mm	8 mm	10 mm
Length	70.5 mm	86.2 mm	82.2 mm	97.0 mm
Height w DIN Rail	35 x 7.5 mm 35 x 15 mm	38.0 mm 45.5 mm	43.0 mm 50.5 mm	49.5 mm 57.0 mm
Weight per piece	10.8 g	13.6 g	19.8 g	35.0 g

Technical Data/Ratings

Approvals							UL	IEC
Wire Size (solid stranded)	24-10 AWG	0.2-4 mm ²	24-10 AWG	0.2-4.0 mm ²	24-8 AWG	0.2-6 mm ²	24-6 AWG	0.2-10 mm ²
Voltage Rating	600 V	1000V AC/DC	600 V	1000V AC/DC	600 V	1000V AC/DC	600 V	1000V AC/DC
Current Rating	30 A	32 A	30 A	32 A	50 A	41 A	65 A	57 A
Insulation Material	Polyamide 66		Polyamide 66		Polyamide 66		Polyamide 66	

Installation Instructions

Wire Stripping Length	10 mm	10 mm	14 mm	18 mm
Screwdriver	Flat Head 0.6 x 3.5 mm	Flat Head 0.6 x 3.5 mm	Flat Head 0.8 x 4 mm	Flat Head 0.8 x 4 mm

Terminal Blocks

	Cat. No.	Std. Pk.	Cat. No.	Std. Pk.	Cat. No.	Std. Pk.	Cat. No.	Std. Pk.
Grey (standard)	CX4/3	50	CX4/4	50	CX6/3	50	CX10/3	50
Red R	CX4/3/R	50	CX4/4/R	50	CX6/3/R	50	CX10/3/R	50
Blue BU	CX4/3/BU	50	CX4/4/BU	50	CX6/3/BU	50	CX10/3/BU	50
Black BL	CX4/3/BL	50	CX4/4/BL	50	CX6/3/BL	50	CX10/3/BL	50
Orange O	CX4/3/O	50	CX4/4/O	50	CX6/3/O	50	CX10/3/O	50
Green G	CX4/3/G	50	CX4/4/G	50	CX6/3/G	50	CX10/3/G	50
Yellow Y	CX4/3/Y	50	CX4/4/Y	50	CX6/3/Y	50	CX10/3/Y	50
White W	CX4/3/W	50	CX4/4/W	50	CX6/3/W	50	CX10/3/W	50

Accessories

	Cat. No.	Std. Pk.	Cat. No.	Std. Pk.	Cat. No.	Std. Pk.	Cat. No.	Std. Pk.
End Plate	EPCX4/3	20	EPCX4/4	20	EPCX6/3	20	EPCX10/3	20
Partition Plate	PPCX4/3	20	PPCX4/4	20	-	-	-	-
DIN Rail	2511120 CA701-15/S	20 20	2511120 CA701-15/S	20 20	2511120 CA701-15/S	20 20	2511120 CA701-15/S	20 20
End Stop	CA702 CA802 CA103	50 50 50	CA702 CA802 CA103	50 50 50	CA702 CA802 CA103	50 50 50	CA702 CA802 CA103	50 50 50
Shorting Link/ Jumpers	2 pole JX4/2 3 pole JX4/3 4 pole JX4/4 5 pole - 6 pole - 7 pole - 8 pole JX4/8 10 pole JX4/10 16 pole JX4/16	100 50 50 - - - 50 10 10	JX4/2 JX4/3 JX4/4 - - - JX4/8 JX4/10 JX4/16	100 50 50 - - - 50 10 10	JX6/2 JX6/3 JX6/4 - - - - JX6/10 -	100 50 50 - - - - 10 -	JX10/2 - - - - - - - - -	20 - - - - - - - -
Test Plug	TX4	50	TX4	50	TX6	50	TX10	50
Marking Tag	MT6	1 Pk. (100 tags)	MT6	1 Pk. (100 tags)	MT8	1 Pk. (100 tags)	MT10	1 Pk. (100 tags)
Warning Label	WLX4	1 Pk. (100 tags)	WLX4	1 Pk. (100 tags)	WLX6	1 Pk. (100 tags)	WLX10	1 Pk. (100 tags)

MULTIPLE CONNECTION TERMINAL BLOCKS

CX2.5/4P

CX2.5/4(E)D1

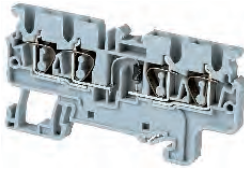
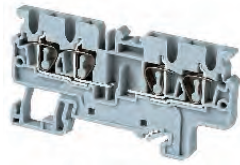

Double potential Terminal Block. 2 different voltage potentials. 2 Jumper Channels on one side

4 connection spring Terminal Block. With built in Diode (1N4007) for reverse polarity protection to allow current only to flow in one direction

Dimensions

Width	5 mm	5 mm
Length	74.7 mm	74.7 mm
Height w DIN Rail	35 x 7.5 mm 35 x 15 mm	38.0 mm 45.5 mm
Weight per piece	9.6 g	9.4 g

Technical Data/Ratings

Approvals				
Wire Size (solid stranded)	24-12 AWG	0.2-2.5 mm ²	24-12 AWG	0.2-2.5 mm ²
Voltage Rating	600 V	1000V AC/DC	600 V	1000V AC/DC
Current Rating	-	-	-	-
Insulation Material	Polyamide 66		Polyamide 66	

Installation Instructions

Wire Stripping Length	10 mm	10 mm
Screwdriver	Flat Head 0.5 x 3 mm	Flat Head 0.6 x 3 mm

Terminal Blocks

	Cat. No.	Std. Pk.	Cat. No.	Std. Pk.
Grey (standard)	CX2.5/4P	50	CX2.5/4(E)D1	50

Accessories

	Cat. No.	Std. Pk.	Cat. No.	Std. Pk.
End Plate	EPCX2.5/4	20	EPCX2.5/4	20
Partition Plate	PPCX4/4	20	PPCX4/4	20
DIN Rail	2511120 CA701-15/S	20 20	2511120 CA701-15/S	20 20
End Stop	CA702 CA802 CA103	50 50 50	CA702 CA802 CA103	50 50 50
Shorting Link/ Jumpers	2 pole 3 pole 4 pole 5 pole 6 pole 7 pole 8 pole 10 pole 16 pole	JX2.5/2 100 JX2.5/3 50 JX2.5/4 50 JX2.5/5 50 JX2.5/6 10 JX2.5/7 10 JX2.5/8 10 JX2.5/10 10 - -	JX2.5/2 100 JX2.5/3 50 JX2.5/4 50 JX2.5/5 50 JX2.5/6 10 JX2.5/7 10 JX2.5/8 10 JX2.5/10 10 - -	
Test Plug	TX2.5	50	TX2.5	50
Marking Tag Warning Label	MT5 WLX2.5	100 100	MT5 WLX2.5	100 100

CX SERIES

SPRING TERMINAL BLOCKS

GROUND / EARTH TERMINAL BLOCKS

HIGHLIGHTS

FEATURES

- 2, 3, 4 Connection Ground Terminals
- Yellow / Green Color as per Industry Standard
- Snap-On feet
- 3 Marking Locations

APPLICATIONS

- Grounding Applications

CXG2.5

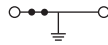

CXG4

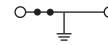
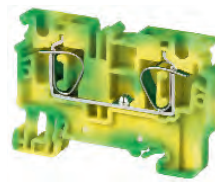

CXG6

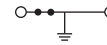
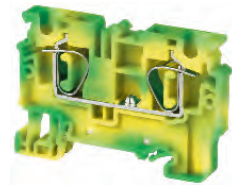

Dimensions

	CXG2.5	CXG4	CXG6
	2 Connection Ground Terminal 2 Jumper Channels	2 Connection Ground Terminal 2 Jumper Channels	2 Connection Ground Terminal 2 Jumper Channels
Width	5 mm	6 mm	8 mm
Length	49.7 mm	54.8 mm	62.1 mm
Height w DIN Rail	35 x 7.5 mm 35 x 15 mm	38.0 mm 45.5 mm	43.0 mm 50.5 mm
Weight per piece	8.4 g	11.0 g	20.2 g

Technical Data/Ratings

Approvals						
Wire Size (solid stranded)	24-12 AWG	0.2-2.5 mm ²	24-10 AWG	0.2-4 mm ²	24-8 AWG	0.2-6 mm ²
Voltage Rating	600 V	1000V AC/DC	600 V	1000V AC/DC	600 V	1000V AC/DC
Current Rating	-	-	-	-	-	-
Insulation Material	Polyamide 66		Polyamide 66		Polyamide 66	

Installation Instructions

Wire Stripping Length	10 mm	10 mm	14 mm
Screwdriver	Flat Head 0.5 x 3 mm	Flat Head 0.6 x 3.5 mm	Flat Head 0.8 x 4 mm

Terminal Blocks

	Cat. No.	Std. Pk.	Cat. No.	Std. Pk.	Cat. No.	Std. Pk.
Yellow / Green	CXG2.5	100	CXG4	100	CXG6	100

Accessories

	Cat. No.	Std. Pk.	Cat. No.	Std. Pk.	Cat. No.	Std. Pk.
End Plate	EPCX2.5	50	EPCX4	50	EPCX6	50
Partition Plate	PPCX4	20	PPCX4	20	PPCX10	20
DIN Rail	2511120 CA701-15/S	20 20	2511120 CA701-15/S	20 20	2511120 CA701-15/S	20 20
End Stop	CA702 CA802 CA103	50 50 50	CA702 CA802 CA103	50 50 50	CA702 CA802 CA103	50 50 50
Shorting Link/ Jumpers	2 pole 3 pole 4 pole 5 pole 6 pole 7 pole 8 pole 10 pole 16 pole	JX2.5/2 100 JX2.5/3 50 JX2.5/4 50 JX2.5/5 50 JX2.5/6 10 JX2.5/7 10 JX2.5/8 10 JX2.5/10 10 - -	JX4/2 100 JX4/3 50 JX4/4 50 - - - - - - JX4/8 50 JX4/10 10 JX4/16 10	JX6/2 100 JX6/3 50 JX6/4 50 - - - - - - - - JX6/10 10 - -		
Test Plug	TX2.5	50	TX4	50	TX6	50
Marking Tag Warning Label	MT5 WLX2.5	100 50	MT6 WLX4	100 100	MT8 WLX6	100 100

MULTIPLE CONNECTION GROUND / EARTH TERMINAL BLOCKS

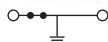
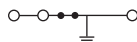
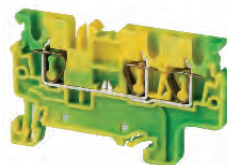
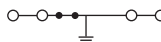
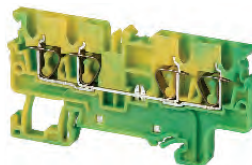
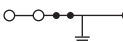
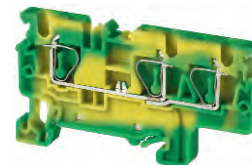
CXG10

CXG2.5/3

CXG2.5/4

CXG4/3

Dimensions

	CXG10	CXG2.5/3	CXG2.5/4	CXG4/3
	2 Connection Ground Terminal 2 Jumper Channels	3 Connection Ground Terminal 2 Jumper Channels	4 Connection Ground Terminal 2 Jumper Channels	3 Connection Ground Terminal 2 Jumper Channels
Width	10 mm	5 mm	5 mm	6 mm
Length	62.1 mm	62.2 mm	74.7 mm	70.5 mm
Height w DIN Rail	35 x 7.5 mm 35 x 15 mm	43.0 mm 50.5 mm	38.0 mm 45.5 mm	38.0 mm 45.5 mm
Weight per piece	29.4 g	10.2 g	12.4 g	14.0 g

Technical Data/Ratings

Approvals								
Wire Size (solid stranded)	24-6 AWG	0.2-10 mm ²	24-12 AWG	0.2-2.5 mm ²	24-12 AWG	0.2-2.5 mm ²	24-10 AWG	0.2-4 mm ²
Voltage Rating	600 V	1000V AC/DC	600 V	1000V AC/DC	600 V	1000V AC/DC	600 V	1000V AC/DC
Current Rating	-	-	-	-	-	-	-	-
Insulation Material	Polyamide 66		Polyamide 66		Polyamide 66		Polyamide 66	

Installation Instructions

Wire Stripping Length	18 mm	10 mm	10 mm	10 mm
Screwdriver	Flat Head 0.8 x 4 mm	Flat Head 0.5 x 3 mm	Flat Head 0.5 x 3 mm	Flat Head 0.6 x 3.5 mm

Terminal Blocks

	Cat. No.	Std. Pk.	Cat. No.	Std. Pk.	Cat. No.	Std. Pk.	Cat. No.	Std. Pk.
Yellow / Green	CXG10	50	CXG2.5/3	100	CXG2.5/4	50	CXG4/3	50

Accessories

	Cat. No.	Std. Pk.	Cat. No.	Std. Pk.	Cat. No.	Std. Pk.	Cat. No.	Std. Pk.
End Plate	EPCX10	20	EPCX2.5/3	50	EPCX2.5/4	20	EPCX4/3	20
Partition Plate	PPCX10	20	PPCX4/3	20	PPCX4/4	20	PPCX4/3	20
DIN Rail	2511120 CA701-15/S	20 20	2511120 CA701-15/S	20 10	2511120 CA701-15/S	20 10	2511120 CA701-15/S	20 10
End Stop	CA702 CA802 CA103	50 50 50	CA702 CA802 CA103	50 50 50	CA702 CA802 CA103	50 50 50	CA702 CA802 CA103	50 50 50
Shorting Link/ Jumpers	2 pole JX10/2 3 pole - 4 pole - 5 pole - 6 pole - 7 pole - 8 pole - 10 pole - 16 pole -	20 - - - - - - - -	JX2.5/2 JX2.5/3 JX2.5/4 JX2.5/5 JX2.5/6 JX2.5/7 JX2.5/8 JX2.5/10 -	100 50 50 50 10 10 10 10 -	JX4/2 JX4/3 JX4/4 - - - - JX4/8 JX4/10 JX4/16	100 50 50 - - - - 50 10 10	JX6/2 JX6/3 JX6/4 - - - - - JX6/10 -	100 50 50 - - - - - 10 -
Test Plug	TX10	50	TX2.5	50	TX2.5	50	TX4	50
Marking Tag Warning Label	MT10 WLX10	100 100	MT5 WLX2.5	100 100	MT5 WLX2.5	100 100	MT6 WLX4	100 100

CX SERIES

SPRING TERMINAL BLOCKS

MULTIPLE CONNECTION GROUND / EARTH TERMINAL BLOCKS

CXG4/4

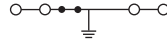
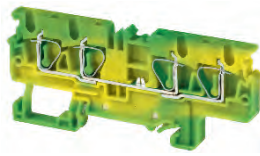

CXG6/3

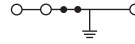
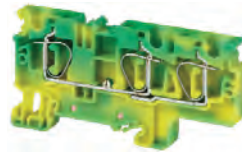

CXG10/3

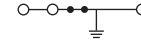
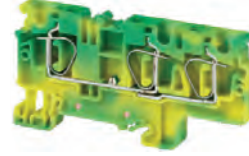

Dimensions

	CXG4/4	CXG6/3	CXG10/3
	4 Connection Ground Terminal 2 Jumper Channels	3 Connection Ground Terminal 2 Jumper Channels	3 Connection Ground Terminal 2 Jumper Channels
Width	6 mm	8 mm	10 mm
Length	86.2 mm	82.2 mm	82.2 mm
Height w/ DIN Rail	35 x 7.5 mm 35 x 15 mm	38.0 mm 45.5 mm	43.0 mm 50.5 mm
Weight per piece	17.2 g	26.0 g	35.0 g

Technical Data/Ratings

Approvals						
Wire Size (solid stranded)	24-10 AWG	0.2-4 mm ²	24-8 AWG	0.2-6 mm ²	24-6 AWG	0.2-10 mm ²
Voltage Rating	600 V	1000V AC/DC	600 V	1000V AC/DC	600 V	1000V AC/DC
Current Rating	-	-	-	-	-	-
Insulation Material	Polyamide 66		Polyamide 66		Polyamide 66	

Installation Instructions

Wire Stripping Length	10 mm	10 mm	18 mm
Screwdriver	Flat Head 0.6 x 3.5 mm	Flat Head 0.8 x 4 mm	Flat Head 0.8 x 4 mm

Terminal Blocks

	Cat. No.	Std. Pk.	Cat. No.	Std. Pk.	Cat. No.	Std. Pk.
Yellow / Green	CXG4/4	50	CXG6/3	50	CXG10/3	50

Accessories

	Cat. No.	Std. Pk.	Cat. No.	Std. Pk.	Cat. No.	Std. Pk.	
End Plate	EPCX4/4	20	EPCX6/3	20	EPCX10/3	20	
Partition Plate	PPCX4/4	20	-	-	-	-	
DIN Rail	2511120 CA701-15/S	20 20	2511120 CA701-15/S	20 20	2511120 CA701-15/S	20 20	
End Stop	CA702 CA802 CA103	50 50 50	CA702 CA802 CA103	50 50 50	CA702 CA802 CA103	50 50 50	
Shorting Link/ Jumpers	2 pole 3 pole 4 pole 5 pole 6 pole 7 pole 8 pole 10 pole 16 pole	JX4/2 JX4/3 JX4/4 - - - - JX4/8 JX4/10 JX4/16	100 50 50 - - - - 50 10 10	JX6/2 JX6/3 JX6/4 - - - - JX6/10 -	100 50 50 - - - - 10 -	JX10/2 - - - - - - - - -	20 - - - - - - - -
Test Plug	TX4	50	TX6	50	TX10	50	
Marking Tag Warning Label	MT6 WLX4	100 100	MT8 WLX6	100 100	MT10 WLX10	100 100	

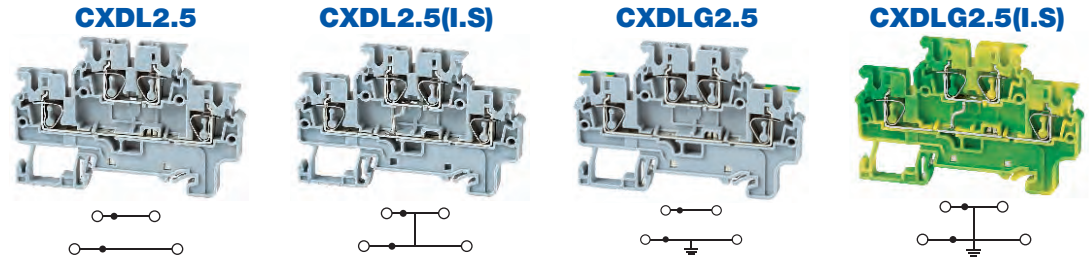

Dimensions

	CXDL2.5	CXDL2.5(I.S)	CXDLG2.5	CXDLG2.5(I.S)
Width	5 mm	5 mm	5 mm	5 mm
Length	71 mm	71 mm	71 mm	71 mm
Height w DIN Rail	35 x 7.5 mm 35 x 15 mm	49.5 mm 57 mm	49.5 mm 57 mm	49.5 mm 57 mm
Weight per piece	10.4 g	11.0 g	13.2 g	13.8 g

Technical Data/Ratings

Approvals	E220514		60947-7-1		E220514		60947-7-1	
Wire Size (solid stranded)	24-12 AWG	0.2-2.5 mm ²	24-12 AWG	0.2-2.5 mm ²	24-12 AWG	0.2-2.5 mm ²	24-12 AWG	0.2-2.5 mm ²
Voltage Rating	600 V	1000V AC/DC	600 V	1000V AC/DC	600 V	1000V AC/DC	600 V	1000V AC/DC
Current Rating	20 A	24 A	20 A	24 A	20 A (Top Level)	24 A (Top Level)	-	-
Insulation Material	Polyamide 66		Polyamide 66		Polyamide 66		Polyamide 66	

Installation Instructions

Wire Stripping Length	10 mm	10 mm	10 mm	10 mm
Screwdriver	Flat Head 0.5 x 3 mm	Flat Head 0.5 x 3 mm	Flat Head 0.5 x 3 mm	Flat Head 0.5 x 3 mm

Terminal Blocks

	Cat. No.	Std. Pk.	Cat. No.	Std. Pk.	Cat. No.	Std. Pk.	Cat. No.	Std. Pk.
Grey (standard)	CXDL2.5	50	CXDL2.5(I.S)	50	CXDLG2.5	50	CXDLG2.5(I.S)	50
Red R	CXDL2.5/R	50	CXDL2.5(I.S)/R	50	Yellow / Green		Yellow / Green	
Blue BU	CXDL2.5/BU	50	CXDL2.5(I.S)/BU	50				
Black BL	CXDL2.5/BL	50	CXDL2.5(I.S)/BL	50				
Orange O	CXDL2.5/O	50	CXDL2.5(I.S)/O	50				
Green G	CXDL2.5/G	50	CXDL2.5(I.S)/G	50				
Yellow Y	CXDL2.5/Y	50	CXDL2.5(I.S)/Y	50				
White W	CXDL2.5/W	50	CXDL2.5(I.S)/W	50				

Accessories

	Cat. No.	Std. Pk.	Cat. No.	Std. Pk.	Cat. No.	Std. Pk.	Cat. No.	Std. Pk.
End Plate	EPCXDL2.5	50	EPCXDL2.5	50	EPCXDL2.5	50	EPCXDL2.5	50
Partition Plate	-	-	-	-	-	-	-	-
DIN Rail	2511120 CA701-15/S	20 20	2511120 CA701-15/S	20 20	2511120 CA701-15/S	20 20	2511120 CA701-15/S	20 20
End Stop	CA702 CA802 CA103	50 50 50	CA702 CA802 CA103	50 50 50	CA702 CA802 CA103	50 50 50	CA702 CA802 CA103	50 50 50
Shorting Link/ Jumpers	2 pole JX2.5/2 3 pole JX2.5/3 4 pole JX2.5/4 5 pole JX2.5/5 6 pole JX2.5/6 7 pole JX2.5/7 8 pole JX2.5/8 10 pole JX2.5/10 16 pole -	100 50 50 50 10 10 10 10 -	JX2.5/2 JX2.5/3 JX2.5/4 JX2.5/5 JX2.5/6 JX2.5/7 JX2.5/8 JX2.5/10 -	100 50 50 50 10 10 10 10 -	JX2.5/2 JX2.5/3 JX2.5/4 JX2.5/5 JX2.5/6 JX2.5/7 JX2.5/8 JX2.5/10 -	100 50 50 50 10 10 10 10 -	JX2.5/2 JX2.5/3 JX2.5/4 JX2.5/5 JX2.5/6 JX2.5/7 JX2.5/8 JX2.5/10 -	100 50 50 50 10 10 10 10 -
Test Plug	TX2.5	50	TX2.5	50	TX2.5	50	TX2.5	50
Marking Tag Warning Label	MT5 WLX2.5	100 100	MT5 WLX2.5	100 100	MT5 WLX2.5	100 100	MT5 WLX2.5	100 100

HIGHLIGHTS

FEATURES

- Various configurations of Electronic Components soldered into CXDL2.5 double level Terminal Block
- Various Diode/ Resistor combinations
- Various Indicator options
- 4 Connection points for convenient wiring

APPLICATIONS

- Reverse polarity protection
- Lamp Testing
- AC/ DC voltage Indication

CXDL2.5(E)D1

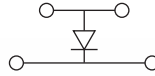
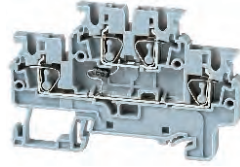

Arc Suppression Circuit Diode

CXDL2.5(E)D2

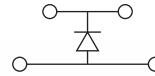
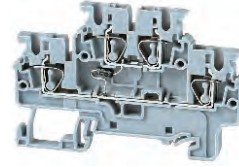

Arc Suppression Circuit Diode

CXDL2.5(E)D3

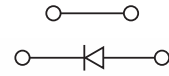

Reverse Polarity Protection Diode

Dimensions

	CXDL2.5(E)D1	CXDL2.5(E)D2	CXDL2.5(E)D3
Width	5 mm	5 mm	5 mm
Length	72.7 mm	72.7 mm	72.7 mm
Height w DIN Rail	35 x 7.5 mm 35 x 15 mm	49.5 mm 57.0 mm	49.5 mm 57.0 mm
Weight per piece	10.6 g	10.6 g	10.6 g

Technical Data/Ratings

Approvals						
Wire Size (solid stranded)	24-12 AWG	0.2-2.5 mm ²	24-12 AWG	0.2-2.5 mm ²	24-12 AWG	0.2-2.5 mm ²
Voltage Rating	600 V	1000V AC/DC	600 V	1000V AC/DC	600 V	1000V AC/DC
Current Rating	-	-	-	-	20 A (Top Level)	24 A (Top Level)
Insulation Material	Polyamide 66		Polyamide 66		Polyamide 66	

Electronic Component Specifications

	CXDL2.5(E)D1	CXDL2.5(E)D2	CXDL2.5(E)D3
Diode Type	1N 4007	1N 4007	1N 4007
Diode Reverse Voltage / Current	1000 V / 1 A	1000 V / 1 A	1000 V / 1 A
Indicator Voltage	-	-	-

Installation Instructions

	CXDL2.5(E)D1	CXDL2.5(E)D2	CXDL2.5(E)D3
Wire Stripping Length	10 mm	10 mm	10 mm
Screwdriver	Flat Head 0.5 x 3 mm	Flat Head 0.5 x 3 mm	Flat Head 0.5 x 3 mm

Terminal Blocks

	Cat. No.	Std. Pk.	Cat. No.	Std. Pk.	Cat. No.	Std. Pk.
Grey (standard)	CXDL2.5(E)D1	50	CXDL2.5(E)D2	50	CXDL2.5(E)D3	50

Accessories

	Cat. No.	Std. Pk.	Cat. No.	Std. Pk.	Cat. No.	Std. Pk.	
End Plate	EPCXDL2.5	50	EPCXDL2.5	50	EPCXDL2.5	50	
DIN Rail	2511120 CA701-15/S	20 20	2511120 CA701-15/S	20 20	2511120 CA701-15/S	20 20	
End Stop	CA702 CA802 CA103	50 50 50	CA702 CA802 CA103	50 50 50	CA702 CA802 CA103	50 50 50	
Shorting Link/ Jumpers	2 pole 3 pole 4 pole 5 pole 6 pole 7 pole 8 pole 10 pole 16 pole	JX2.5/2 JX2.5/3 JX2.5/4 JX2.5/5 JX2.5/6 JX2.5/7 JX2.5/8 JX2.5/10 -	100 50 50 50 10 10 10 10 -	JX2.5/2 JX2.5/3 JX2.5/4 JX2.5/5 JX2.5/6 JX2.5/7 JX2.5/8 JX2.5/10 -	100 50 50 50 10 10 10 10 -	JX2.5/2 JX2.5/3 JX2.5/4 JX2.5/5 JX2.5/6 JX2.5/7 JX2.5/8 JX2.5/10 -	100 50 50 50 10 10 10 10 -
Marking Tag	MT5	100	MT5	100	MT5	100	

CXDL2.5(E)DD1/DD2 CXDL2.5(E)DD3/DD4 CXDL2.5(E)LD1

CXDL2.5(E)TS1

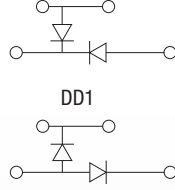
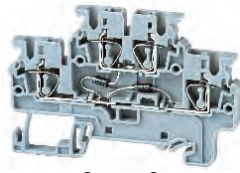

Diode Circuit for lamp testing
DD2

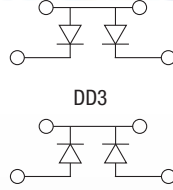

Diode Circuit for lamp testing
DD4

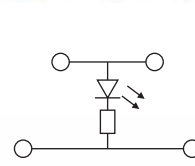
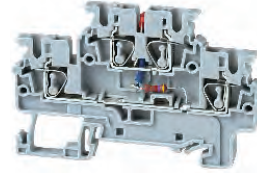

Voltage Indicator

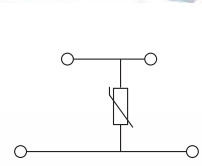

PT100 Temperature Sensor

Dimensions

Width	5 mm	5 mm	5 mm	5 mm
Length	72.7 mm	72.7 mm	72.7 mm	72.7 mm
Height w DIN Rail	35 x 7.5 mm 35 x 15 mm	49.5 mm 57.0 mm	49.5 mm 57.0 mm	49.5 mm 57.0 mm
Weight per piece	10.6 g	10.6 g	10.6 g	12.2 g

Technical Data/Ratings

Approvals				
Wire Size (solid stranded)	24-12 AWG	0.2-2.5 mm ²	24-12 AWG	0.2-2.5 mm ²
Voltage Rating	600 V	1000V AC/DC	600 V	1000V AC/DC
Current Rating	-	-	-	-
Insulation Material	Polyamide 66			

Electronic Component Specifications

Diode Type	1N 4007	1N 4007	1N 4007	1N 4007
Diode Reverse Voltage / Current	1000 V / 1 A	1000 V / 1 A	1000 V / 1 A	1000 V / 1 A
Indicator Voltage	-	-	6-60V / 110-240V	-

Installation Instructions

Wire Stripping Length	10 mm	10 mm	10 mm	10 mm
Screwdriver	Flat Head 0.5 x 3 mm	Flat Head 0.5 x 3 mm	Flat Head 0.5 x 3 mm	Flat Head 0.5 x 3 mm

Terminal Blocks

	Cat. No.	Std. Pk.	Cat. No.	Std. Pk.	Cat. No.	Std. Pk.	Cat. No.	Std. Pk.
Grey (standard)	CXDL2.5(E)DD1	50	CXDL2.5(E)DD3	50	CXDL2.5(E)LD1/6-60V	50	CXDL2.5(E)TS1	50
	CXDL2.5(E)DD2	50	CXDL2.5(E)DD4	50	CXDL2.5(E)LD1/110-240V	50		

Accessories

	Cat. No.	Std. Pk.	Cat. No.	Std. Pk.	Cat. No.	Std. Pk.	Cat. No.	Std. Pk.
End Plate	EPCXDL2.5	50	EPCXDL2.5	50	EPCXDL2.5	50	EPCXDL2.5	50
DIN Rail	2511120 CA701-15/S	20 20	2511120 CA701-15/S	20 20	2511120 CA701-15/S	20 20	2511120 CA701-15/S	20 20
End Stop	CA702 CA802 CA103	50 50 50	CA702 CA802 CA103	50 50 50	CA702 CA802 CA103	50 50 50	CA702 CA802 CA103	50 50 50
Shorting Link/ Jumpers	2 pole 3 pole 4 pole 5 pole 6 pole 7 pole 8 pole 10 pole 16 pole	JX2.5/2 JX2.5/3 JX2.5/4 JX2.5/5 JX2.5/6 JX2.5/7 JX2.5/8 JX2.5/10 -	100 50 50 50 10 10 10 10 -	JX2.5/2 JX2.5/3 JX2.5/4 JX2.5/5 JX2.5/6 JX2.5/7 JX2.5/8 JX2.5/10 -	100 50 50 50 10 10 10 10 -	JX2.5/2 JX2.5/3 JX2.5/4 JX2.5/5 JX2.5/6 JX2.5/7 JX2.5/8 JX2.5/10 -	100 50 50 50 10 10 10 10 -	JX2.5/2 JX2.5/3 JX2.5/4 JX2.5/5 JX2.5/6 JX2.5/7 JX2.5/8 JX2.5/10 -
Marking Tag	MT5	100	MT5	100	MT5	100	MT5	100

CX SERIES

SPRING TERMINAL BLOCKS

FUSE TERMINAL BLOCKS 5 x 20 mm

HIGHLIGHTS

FEATURES

- CXF4 Series accepts 5x20mm / 5x25mm fuse types
- Completely enclosed, no endplates
- Version with LED for blown fuse indication
- AC and DC compatible
- Large marking area
- No polarity required

APPLICATIONS

- Control systems with fuse protection

CXF4

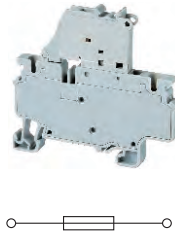

CXF4(L)6-60V

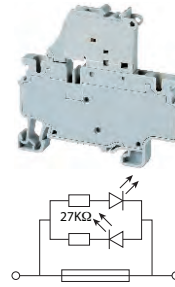

CXF4(L)110-240V

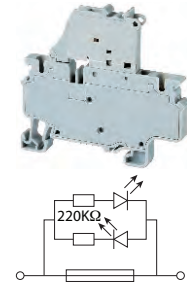

Dimensions

Width	6 mm	6 mm	6 mm
Length	65.4 mm	65.4 mm	65.4 mm
Height w DIN Rail	35 x 7.5 mm 35 x 15 mm	61.3 mm 68.8 mm	61.3 mm 68.8 mm
Weight per piece	16 g	16 g	16 g

Technical Data/Ratings

Approvals						
Wire Size (solid stranded)	24-10 AWG	0.2-4 mm ²	24-10 AWG	0.2-4 mm ²	24-10 AWG	0.2-4 mm ²
Voltage Rating	600 V	1000V AC/DC	600 V	1000V AC/DC	600 V	1000V AC/DC
Current Rating	10 A	10 A	10 A	10 A	10 A	10 A
Insulation Material	Polyamide 66		Polyamide 66		Polyamide 66	

Fuse Specifications

Fuse Type	5x20 mm	5x20 mm	5x20 mm
LED Indicator Voltage	-	6-60V AC/DC	110-240V AC/DC

Installation Instructions

Wire Stripping Length	10 mm	10 mm	10 mm
Screwdriver	Flat Head 0.6 x 3.5 mm	Flat Head 0.6 x 3.5 mm	Flat Head 0.6 x 3.5 mm

Terminal Blocks

	Cat. No.	Std. Pk.	Cat. No.	Std. Pk.	Cat. No.	Std. Pk.
Grey (standard)	CXF4	50	CXF4(L)6-60V	50	CXF(L)110-240V	50
Blue BU	CXF4/BU	50	CXF4(L)6-60V/BU	50	CXF4(L)110-240V/BU	50
Black BL	CXF4/BL	50	CXF4(L)6-60V/BL	50	CXF4(L)110-240V/BL	50

Accessories

	Cat. No.	Std. Pk.	Cat. No.	Std. Pk.	Cat. No.	Std. Pk.
DIN Rail	2511120 CA701-15/S	20 10	2511120 CA701-15/S	20 10	2511120 CA701-15/S	20 10
Shorting Link/ Jumpers	2 pole 3 pole 4 pole 8 pole 10 pole 16 pole	JX4/2 100 JX4/3 50 JX4/4 50 JX4/8 50 JX4/10 10 JX4/16 10	JX4/2 100 JX4/3 50 JX4/4 50 JX4/8 50 JX4/10 10 JX4/16 10	JX4/2 100 JX4/3 50 JX4/4 50 JX4/8 50 JX4/10 10 JX4/16 10	JX4/2 100 JX4/3 50 JX4/4 50 JX4/8 50 JX4/10 10 JX4/16 10	JX4/2 100 JX4/3 50 JX4/4 50 JX4/8 50 JX4/10 10 JX4/16 10
Test Plug	TX4	50	TX4	50	TX4	50
Marking Tag Warning Label	MT6 WLX4	100 100	MT6 WLX4	100 100	MT6 WLX4	100 100

Fuses 5 x 20 mm



Current Rating	Slow Blow Cat. No	Fast Blow Cat. No	Current Rating	Slow Blow Cat. No	Fast Blow Cat. No
0.1A	0.1M5x20T	0.1M5x20F	4.0A	4.0M5x20T	4.0M5x20F
0.2A	0.2M5x20T	0.2M5x20F	5.0A	5.0M5x20T	5.0M5x20F
0.5A	0.5M5x20T	0.5M5x20F	6.3A	6.3M5x20T	6.3M5x20F
1.0A	1.0M5x20T	1.0M5x20F	8.0A	8.0M5x20T	8.0M5x20F
2.0A	2.0M5x20T	2.0M5x20F	10.0A	10.0M5x20T	10.0M5x20F

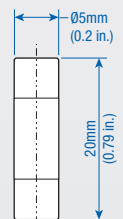

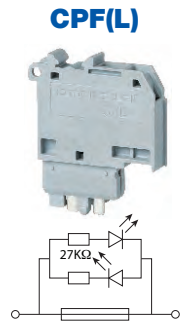

Dimensions

Width	6 mm	6 mm	6 mm	6 mm
Length	65.4 mm	28 mm	28 mm	28 mm
Height w DIN Rail	35 x 7.5 mm 35 x 15 mm	61.3 mm 68.8 mm		
Weight per piece	10.2 g	3.8 g	3.8 g	4.2 g

Technical Data/Ratings

Approvals				
Wire Size (solid stranded)	24-10 AWG	0.2-4 mm ²	24-10 AWG	0.2-4 mm ²
Voltage Rating	600 V	1000V AC/DC	600 V	1000V AC/DC
Current Rating	*	*	1 A	1 A
Insulation Material	Polyamide 66			

Carrier Specifications

Component Type	Component carrier base	Plug module with diode Diode Type IN4007	Plug module for 5x20 mm fuse	Plug module for 5x20 mm fuse with LED indicator
LED Indicator Voltage	-	-	-	6-60V AC/DC 110-240V AC/DC

Installation Instructions

Wire Stripping Length	10 mm	-	-	-
Screwdriver	Flat Head 0.6 x 3.5 mm	-	-	-

Terminal Blocks

	Cat. No.	Std. Pk.	Cat. No.	Std. Pk.	Cat. No.	Std. Pk.	Cat. No.	Std. Pk.
Grey (standard)	CXCC4	50	CPD1	50	CPF	50	CPF(L)6-60V	50
							CPF(L)110-240V	50

Accessories

DIN Rail	Cat. No.	Std. Pk.	Cat. No.	Std. Pk.	Cat. No.	Std. Pk.	Cat. No.	Std. Pk.
	2511120	20	-	-	-	-	-	-
	CA701-15/S	10	-	-	-	-	-	-
End Stop	CA702	50	-	-	-	-	-	-
	CA802	50	-	-	-	-	-	-
	CA103	50	-	-	-	-	-	-
Shorting Link/ Jumpers	2 pole	JX4/2	100	-	-	-	-	-
	3 pole	JX4/3	50	-	-	-	-	-
	4 pole	JX4/4	50	-	-	-	-	-
	8 pole	JX4/8	50	-	-	-	-	-
	10 pole	JX4/10	10	-	-	-	-	-
	16 pole	JX4/16	10	-	-	-	-	-
Test Plug	TX4	50	-	-	-	-	-	-
Marking Tag	MT6	100	MT6	100	MT6	100	MT6	100
Warning Label	SWL4	50	-	-	-	-	-	-

* Current rating is based on plug used.

CX SERIES

SPRING TERMINAL BLOCKS

DISCONNECT & TEST TERMINAL BLOCKS

CXK2.5

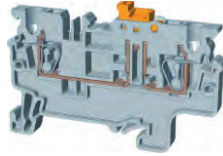

CXK2.5/4

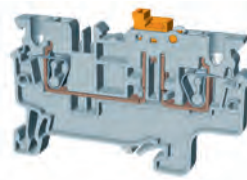

CXK4



Dimensions

	CXK2.5	CXK2.5/4	CXK4
Width	5 mm	5 mm	6 mm
Length	62.2 mm	74.7 mm	70.5 mm
Height w DIN Rail	35 x 7.5 mm 35 x 15 mm	38 mm 45.5 mm	38 mm 45.5 mm
Weight per piece	8.65 g	11.9 g	11.2 g

Technical Data/Ratings

Approvals						
Wire Size (solid stranded)	24-12 AWG	0.2-2.5 mm ²	24-12 AWG	0.2-2.5 mm ²	24-12 AWG	0.2-2.5 mm ²
Voltage Rating	600 V	1000V AC/DC	600 V	1000V AC/DC	600 V	1000V AC/DC
Current Rating	16A	20A	16A	20A	22A	22A
Insulation Material	Polyamide 66		Polyamide 66		Polyamide 66	

Installation Instructions

Wire Stripping Length	10 mm	10 mm	10 mm
Screwdriver	Flat Head 0.5 x 3 mm	Flat Head 0.5 x 3 mm	Flat Head 0.6 x 3.5 mm

Terminal Blocks

	Cat. No.	Std. Pk.	Cat. No.	Std. Pk.	Cat. No.	Std. Pk.
Grey (standard)	CXK2.5	50	CXK2.5/4	50	CXK4	50
Red R	CXK2.5/R	50	CXK2.5/4/R	50	CXK4/R	50
Blue BU	CXK2.5/BU	50	CXK2.5/4/BU	50	CXK4/BU	50
Black BL	CXK2.5/BL	50	CXK2.5/4/BL	50	CXK4/BL	50
Orange O	CXK2.5/O	50	CXK2.5/4/O	50	CXK4/O	50
Green G	CXK2.5/G	50	CXK2.5/4/G	50	CXK4/G	50
Yellow Y	CXK2.5/Y	50	CXK2.5/4/Y	50	CXK4/Y	50
White W	CXK2.5/W	50	CXK2.5/4/W	50	CXK4/W	50

Accessories

	Cat. No.	Std. Pk.	Cat. No.	Std. Pk.	Cat. No.	Std. Pk.
End Plate	EPCX2.5/3	50	EPCX2.5/4	50	-	-
Partition Plate	PPCX4/3	20	PPCX4/4	20	PPCX4/3	20
DIN Rail	2511120 CA701-15/S	20 10	2511120 CA701-15/S	20 10	2511120 CA701-15/S	20 10
End Stop	CA702 CA802 CA103	50 50 50	CA702 CA802 CA103	50 50 50	CA702 CA802 CA103	50 50 50
Shorting Link/ Jumpers	2 pole JX2.5/2 3 pole JX2.5/3 4 pole JX2.5/4 5 pole JX2.5/5 6 pole JX2.5/6 7 pole JX2.5/7 8 pole JX2.5/8 10 pole JX2.5/10 16 pole -	100 50 50 50 10 10 10 10 10 -	2 pole JX2.5/2 3 pole JX2.5/3 4 pole JX2.5/4 5 pole JX2.5/5 6 pole JX2.5/6 7 pole JX2.5/7 8 pole JX2.5/8 10 pole JX2.5/10 -	100 50 50 50 10 10 10 10 10 -	2 pole JX4/2 3 pole JX4/3 4 pole JX4/4 -	100 50 50 -
Test Plug	TX2.5	50	TX2.5	50	TX4	50
Marking Tag	MT5	100	MT5	100	MT6	100
Warning Label	WLX2.5	100	WLX2.5	100	WLX4	100

CXS2.5



CXS4



CXSG2.5, CXSG4



HIGHLIGHTS

FEATURES

- Side Entry Spring Terminals
- Compact Design
- Same Jumpers as regular CX Series
- 5mm and 6mm Feed Through Terminal
- 2 Connection Ground Blocks
- Low Height requirements

APPLICATIONS

- Flat Cabinets
- Same wire entry as regular screw terminals

Dimensions

	5 mm Side Entry Feed Through	6 mm Side Entry Feed Through	5 / 6 mm Side Entry Ground Terminal
Width	5 mm	6 mm	5 / 6 mm
Length	43 mm	43 mm	43 mm
Height w/ DIN Rail	35 x 7.5 mm 35 x 15 mm	43.5 mm 51 mm	43.5 mm 51 mm
Weight per piece	5.4 g	g	8.4 g

Technical Data/Ratings

Approvals							
Wire Size	CXS2.5 CXS4	24-12 AWG -	0.2-2.5 mm ² -	- 24-10 AWG	- 0.2-4 mm ²	24-12 AWG 24-10 AWG	0.2-2.5 mm ² 0.2-4 mm ²
Voltage Rating		600 V	1000V AC/DC	600 V	1000V AC/DC	600 V	1000V AC/DC
Current Rating		20A	24A	30A	32A	-	-
Insulation Material	Polyamide 66		Polyamide 66		Polyamide 66		

Installation Instructions

Wire Stripping Length	9 mm	10 mm	10 mm
Screwdriver	Flat Head 0.5 x 3 mm	Flat Head 0.5 x 3 mm	Flat Head 0.5 x 3 mm

Terminal Blocks

	Cat. No.	Std. Pk.	Cat. No.	Std. Pk.	Cat. No.	Std. Pk.
Grey (standard)	CXS2.5	50	CXS4	50	CXSG2.5	50
Red R	CXS2.5/R	50	CXS4/R	50	CXSG4	50
Blue BU	CXS2.5/BU	50	CXS4/BU	50	Yellow / Green	
Black BL	CXS2.5/BL	50	CXS4/BL	50		
Orange O	CXS2.5/O	50	CXS4/O	50		
Green G	CXS2.5/G	50	CXS4/G	50		
Yellow Y	CXS2.5/Y	50	CXS4/Y	50		
White W	CXS2.5/W	50	CXS4/W	50		



Accessories

	Cat. No.	Std. Pk.	Cat. No.	Std. Pk.	Cat. No.	Std. Pk.	
End Plate	EPCXS2.5	50	EPCXS2.5	50	EPCXS2.5	50	
DIN Rail	2511120 CA701-15/S	20 20	2511120 CA701-15/S	20 20	2511120 CA701-15/S	20 20	
End Stop	CA702 CA802 CA103	50 50 50	CA702 CA802 CA103	50 50 50	CA702 CA802 CA103	50 50 50	
Shorting Link/ Jumpers	2 pole 3 pole 4 pole 5 pole 6 pole 7 pole 8 pole 10 pole 16 pole	JX2.5/2 JX2.5/3 JX2.5/4 JX2.5/5 JX2.5/6 JX2.5/7 JX2.5/8 JX2.5/10 -	100 50 50 50 10 10 10 10 -	JX4/2 JX4/3 JX4/4 - - - JX4/8 JX4/10 JX4/16	100 50 50 - - - 10 10 10	JX2.5/2 JX2.5/3 JX2.5/4 JX2.5/5 JX2.5/6 JX2.5/7 JX2.5/8 JX2.5/10 -	100 50 50 50 10 10 10 10 -
Test Plug	TX2.5	50	-	-	-	-	
Marking Tag Warning Label	MT5 WLX2.5	100 100	MT5 WLX2.5	100 100	MT5 WL2.5	100 100	

CX-PLUGGABLE

SPRING TERMINAL BLOCKS

PLUGGABLE FEED-THROUGH TERMINAL BLOCKS

HIGHLIGHTS

FEATURES

- Pluggable Terminal Blocks
- Pluggable Wire to DIN Rail connection (CX2.5/1B-CX2.5PN)
- Pluggable Wire to Wire Connection (CX2.5SN - CX2.5PN)
- Easy Clip multi-wire solution
- Polarizing plug with coding pin CXPOL
- 2/4 way strain relief (CXSR2N, CXSR4N)

APPLICATIONS

- Wire harness for easy connection
- Pluggable wire to wire connection inside panels

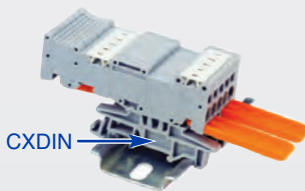
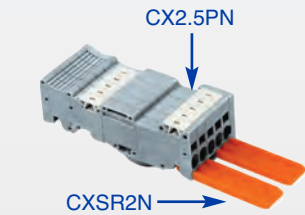
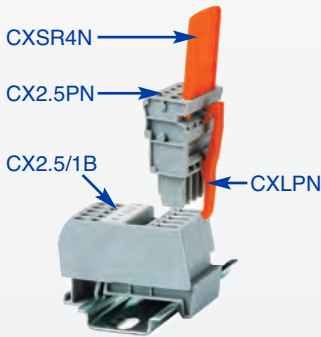

CX2.5/1B

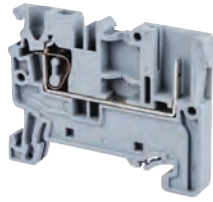

CX2.5PN



CX2.5SN



Dimensions & Weight

	DIN Rail Base	Stackable Terminal Plug	Stackable Terminal Socket
Width	5 mm	5 mm	5 mm
Length	50.8 mm	17.5 mm	18 mm
Height w DIN Rail	35 x 7.5 mm 35 x 15 mm	38.2 mm 45.7 mm	42.0 mm 40.0 mm
Weight per piece	6.6 g	6.3 g	6.0 g

Technical Data/Ratings

Approvals	UL	IEC 60947-7-1	UL	IEC 60947-7-1	UL	IEC 60947-7-1
Wire Size (solid / stranded)	24-12 AWG	0.2-2.5 mm ²	24-12 AWG	0.2-2.5 mm ²	24-12 AWG	0.2-2.5 mm ²
Voltage Rating	300 V	800 V	300 V	800 V	300 V	800 V
Current Rating	20 A	24 A	20 A	24 A	20 A	24 A
Insulation Material	Polyamide 66			Polyamide 66		

Installation Instructions

Wire Stripping Length	8 mm	8 mm	8 mm
Screwdriver	Flat Head 0.5 x 3 mm	Flat Head 0.5 x 3 mm	Flat Head 0.5 x 3 mm

Terminal Blocks

	Cat. No.	Std. Pk.	Cat. No.	Std. Pk.	Cat. No.	Std. Pk.
Grey (standard) Start Element	CX2.5/1B	100	CX2.5PN	50	CX2.5SN	50
Last Element			CX2.5PLN	50	CX2.5SLN	50
2 pole			CX2.5PN/2	50	CX2.5SN/2	50
3 pole			CX2.5PN/3	50	CX2.5SN/3	50
4 pole			CX2.5PN/3	50	CX2.5SN/4	50
5 pole			CX2.5PN/4	50	CX2.5SN/5	50
6 pole			CX2.5PN/5	50	CX2.5SN/6	50

Accessories

	Cat. No.	Std. Pk.	Cat. No.	Std. Pk.	Cat. No.	Std. Pk.
End Plate	EPCX2.5	50	-	-	-	-
DIN Rail	2511120 CA701-15/S	20 20	2511120 CA701-15/S	20 20	2511120 CA701-15/S	20 20
End Clamp	CA702 CA802 CA103	50 50 50	CA702 CA802 CA103	50 50 50	CA702 CA802 CA103	50 50 50
Shorting Link/ Jumpers	2 pole 3 pole 4 pole 5 pole 6 pole 7 pole 8 pole 10 pole	JX2.5/2 JX2.5/3 JX2.5/4 JX2.5/5 JX2.5/6 JX2.5/7 JX2.5/8 JX2.5/10	100 50 50 50 10 10 10 10	- - - - - - - -	- - - - - - - -	- - - - - - - -
DIN Mounting Foot	-	-	-	-	CXDIN	25
Locking Clip	-	-	CXLPN	25	-	-
Strain Relief	2 Way 4 Way	- -	CXSR2N CXSR4N	25 25	CXSR2N CXSR4N	25 25
Coding Pin	CXPOL	25	CXPOL	25	CXPOL	25
Marking Tag	MT5	1 Pk. (100 tags)	MT5	1 Pk. (100 tags)	MT5	1 Pk. (100 tags)

CXDB35/10

CXDB35/10A

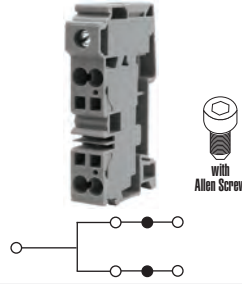

1 Flat Head Screw Input
4 Spring Clamp Outputs

1 Hex Screw Input
4 Spring Clamp Outputs

Dimensions & Weight

Width	16 mm	16 mm
Length	81.6 mm	81.6 mm
Height w DIN Rail	35 x 7.5 mm 35 x 15 mm	46.8 mm 54.3 mm
Weight per piece	53.2 g	53.2 g

General Specifications

Approvals		
Voltage Rating	600 V 1000V AC/DC	600 V 1000V AC/DC
Insulation Material	Polyamide 66	Polyamide 66

INPUT

Technical Data/Ratings

Wire Size (solid / stranded)	14-2 AWG 1.5-35 mm ²	14-2 AWG 1.5-35 mm ²
Current Rating	115 A 125 A	115 A 125 A
Torque	25 lb-in 2.5 Nm	25 lb-in 2.5 Nm

Installation Instructions

Wire Stripping Length	17 mm	17 mm
Screwdriver	Flat Head 1.0 x 5.5 mm	Hex Screw M5

OUTPUT

Technical Data/Ratings

Wire Size (solid / stranded)	24-8 AWG 0.2-10 mm ²	24-8 AWG 0.2-10 mm ²
Current Rating	41 A 41 A	41 A 41 A

Installation Instructions

Wire Stripping Length	15 mm	15 mm
Screwdriver	Flat Head 0.8 x 4 mm	Flat Head 0.8 x 4 mm

Terminal Blocks

	Cat. No.	Std. Pk.	Cat. No.	Std. Pk.
Grey	CXDB35/10	20	CXDB35/10A	20

Accessories

	Cat. No.	Std. Pk.	Cat. No.	Std. Pk.
DIN Rail	2511120 CA701-15/S	20 20	2511120 CA701-15/S	20 20
End Clamp	CA702 CA802 CA103	50 50 50	CA702 CA802 CA103	50 50 50
Jumpers	JX6/2 JX6/3 JX6/4 JX6/10	100 50 50 10	JX6/2 JX6/3 JX6/4 JX6/10	100 50 50 10
Marking Tag	MT16	1 Pk. (100 tags)	MT16	1 Pk. (100 tags)

HIGHLIGHTS

FEATURES

- Hybrid Distribution Terminal Block
- Screw input (115A)
- 4 spring clamp outputs (4 x41A)
- Modular system
- Standard slot & hex screw versions
- Expandable with standard CX Series jumpers and terminal blocks
- Easy Installation

APPLICATIONS

- Miniature Circuit Breaker (MCB) distribution
- Limited space distribution

Output Expansion

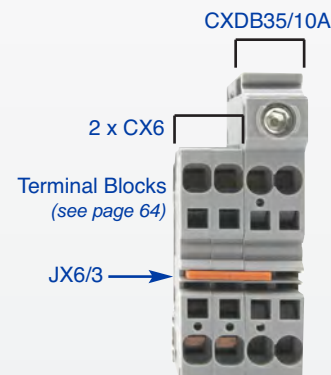

MCB Distribution Example

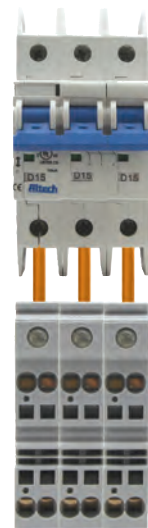

ANGULAR SERIES

SPRING TERMINAL BLOCKS

ANGULAR FEED-THROUGH

HIGHLIGHTS

FEATURES

- 45° Wire entry for easy installation
- 2.5mm to 8mm terminal blocks
- 22-8 AWG wire sizes
- 2, 3, and 4 Connection **Ground Terminals**
- Accessories

APPLICATIONS

- Panels with limited wiring space
- Vibration Applications
- Elevator Cabinets
- People Movers
- Transportation



Dimensions & Weight

	AS2.5	AS4	AS6
	2 Connection Feed-Through 2 Jumper Slots		
Width	5 mm	6 mm	8 mm
Length	54 mm	61.5 mm	74 mm
Height w DIN Rail	35 x 7.5 mm 35 x 15 mm	44.0 mm 51.0 mm	49.3 mm 57.0 mm
Weight per piece	6.5 g	9.0 g	14.8 g

Technical Data/Ratings

Approvals	AS2.5		AS4		AS6	
CE, UL, IEC	UL E220514	IEC 60947-7-1	UL E220514	IEC 60947-7-1	UL E220514	IEC 60947-7-1
Wire Size (solid / stranded)	22-12 AWG	0.34-2.5 mm ²	22-10 AWG	0.2-4 mm ²	22-8 AWG	0.2-6 mm ²
Voltage Rating	600 V	800V AC/DC	600 V	800V AC/DC	600 V	800V AC/DC
Current Rating	25 A	24 A	35 A	32 A	50 A	41 A
Insulation Material	Polyamide 66					

Installation Instructions

Wire Stripping Length	AS2.5	AS4	AS6
Wire Stripping Length	11 mm	15 mm	15 mm
Screwdriver	Flat Head 0.5 x 3mm	Flat Head 0.6 x 3.5 mm	Flat Head 0.8 x 4 mm

Terminal Blocks

	Cat. No.	Std. Pk.	Cat. No.	Std. Pk.	Cat. No.	Std. Pk.
Grey (standard)	AS2.5	100	AS4	100	AS6	50
Red R	AS2.5/R	100	AS4/R	100	AS6/R	50
Blue BU	AS2.5/BU	100	AS4/BU	100	AS6/BU	50
Black BL	AS2.5/BL	100	AS4/BL	100	AS6/BL	50
Orange O	AS2.5/O	100	AS4/O	100	AS6/O	50
Green G	AS2.5/G	100	AS4/G	100	AS6/G	50
Yellow Y	AS2.5/Y	100	AS4/Y	100	AS6/Y	50
White W	AS2.5/W	100	AS4/W	100	AS6/W	50

Accessories

	Cat. No.	Std. Pk.	Cat. No.	Std. Pk.	Cat. No.	Std. Pk.
End Plate	EPAS2.5	50	EPAS4	50	EPAS6	50
DIN Rail	2511120 CA701-15/S	20 20	2511120 CA701-15/S	20 20	2511120 CA701-15/S	20 20
End Stop	CA103 CA702 CA802	50 50 50	CA103 CA702 CA802	50 50 50	CA103 CA702 CA802	50 50 50
2 Pole Jumper	CA801/1	100	CA801/2	100	CA801/3	100
Jumpers Alternate	CA801/1-3	100	CA801/2-3	100	CA801/3-3	100
Push in wire jumper	CA901/1	100	CA901/2	100	CA901/3	100
Step Down Jumper	AS6 to AS4 AS6 to AS2.5 AS4 to AS2.5 AS6 to AS2.5	- 100 100 100	CA901/4 - CA901/6 -	100 - 100 -	CA901/4 CA901/5 - CA801/8	100 100 - 100
Marking Tag	MT5	1 Pk. (100 tags)	MT6	1 Pk. (100 tags)	MT8	1 Pk. (100 tags)

AS2.5/3



AS2.5/4



AS4/3



AS4/4



Dimensions & Weight

	3 Connection Feed-Through 2 Jumper Slots	4 Connection Feed-Through	3 Connection Feed-Through 2 Jumper Slots	4 Connection Feed-Through
Width	5 mm	5 mm	6 mm	6 mm
Length	54 mm	54 mm	61.5 mm	61.5 mm
Height w DIN Rail	35 x 7.5 mm 35 x 15 mm	44.0 mm 51.0 mm	44.0 mm 51.0 mm	44.0 mm 51.0 mm
Weight per piece	7.5 g	15.5 g	11.0 g	12.6 g

Technical Data/Ratings

Approvals								
Wire Size (solid / stranded)	22-12 AWG	0.34-2.5 mm ²	22-12 AWG	0.34-2.5 mm ²	22-10 AWG	0.2-4 mm ²	22-10 AWG	0.2-4 mm ²
Voltage Rating	600 V	800V AC/DC	600 V	800V AC/DC	600 V	800V AC/DC	600 V	800V AC/DC
Current Rating	25 A	24 A	25 A	24 A	35 A	32 A	35 A	32 A
Insulation Material	Polyamide 66		Polyamide 66		Polyamide 66		Polyamide 66	

Installation Instructions

Wire Stripping Length	11 mm	11 mm	15 mm	15 mm
Screwdriver	Flat Head 0.5 x 3 mm	Flat Head 0.5 x 3 mm	Flat Head 0.6 x 3.5 mm	Flat Head 0.6 x 3.5 mm

Terminal Blocks

	Cat. No.	Std. Pk.	Cat. No.	Std. Pk.	Cat. No.	Std. Pk.	Cat. No.	Std. Pk.
Grey (standard)	AS2.5/3	100	AS2.5/4	100	AS4/3	100	AS4/4	100
Red R	AS2.5/3/R	100	AS2.5/4/R	100	AS4/3/R	100	AS4/4/R	100
Blue BU	AS2.5/3/BU	100	AS2.5/4/BU	100	AS4/3/BU	100	AS4/4/BU	100
Black BL	AS2.5/3/BL	100	AS2.5/4/BL	100	AS4/3/BL	100	AS4/4/BL	100
Orange O	AS2.5/3/O	100	AS2.5/4/O	100	AS4/3/O	100	AS4/4/O	100
Green G	AS2.5/3/G	100	AS2.5/4/G	100	AS4/3/G	100	AS4/4/G	100
Yellow Y	AS2.5/3/Y	100	AS2.5/4/Y	100	AS4/3/Y	100	AS4/4/Y	100
White W	AS2.5/3/W	100	AS2.5/4/W	100	AS4/3/W	100	AS4/4/W	100

Accessories

	Cat. No.	Std. Pk.	Cat. No.	Std. Pk.	Cat. No.	Std. Pk.	Cat. No.	Std. Pk.
End Plate	EPAS2.5	50	EPAS2.5	50	EPAS4	50	EPAS4	50
DIN Rail	2511120 CA701-15/S	20 20	2511120 CA701-15/S	20 20	2511120 CA701-15/S	20 20	2511120 CA701-15/S	20 20
End Stop	CA103 CA702 CA802	50 50 50	CA103 CA702 CA802	50 50 50	CA103 CA702 CA802	50 50 50	CA103 CA702 CA802	50 50 50
2 Pole Jumper	CA801/1	100	DOES NOT ACCEPT JUMPERS		CA801/2	100	DOES NOT ACCEPT JUMPERS	
Jumpers Alternate	CA801/1-3	100	-	-	CA801/2-3	100	-	-
Push in wire jumper	CA901/1	100	-	-	CA901/2	100	-	-
Step Down Jumper	AS6 to AS4 AS6 to AS2.5 AS4 to AS2.5 AS6 to AS2.5	- CA901/5 CA901/6 CA801/8	- 100 100 100	- - - -	CA901/4 - CA901/6 -	100 - 100 -	- - - -	- - - -
Marking Tag	MT5	1 Pk. (100 tags)	MT5	1 Pk. (100 tags)	MT6	1 Pk. (100 tags)	MT6	1 Pk. (100 tags)

ANGULAR SERIES

SPRING TERMINAL BLOCKS

DOUBLE LEVEL ANGULAR FEED-THROUGH

AS6/3



ADL2.5(E)D1/D2

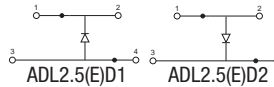

ADLG2.5

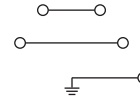

Dimensions & Weight

	AS6/3	ADL2.5(E)D1/D2	ADLG2.5
Width	8 mm	5 mm	5 mm
Length	74 mm	79.5 mm	83.7 mm
Height w DIN Rail	35 x 7.5 mm 35 x 15 mm	49.5 mm 57 mm	64.8 mm 72.3 mm
Weight per piece	18.6 g	14.0 g	20.9 g

Technical Data/Ratings

Approvals						
Wire Size (solid / stranded)	22-8 AWG / 0.2-6 mm ²		22-12 AWG / 0.34-2.5 mm ²		22-12 AWG / 0.34 mm ²	
Voltage Range	600V / 800V		300V / 800V		600V / 800V	
Current Rating	50 A / 41 A		25 A / 24 A		20 A / 24 A	
Insulation Material	Polyamide 66		Polyamide 66		Polyamide 66	

Installation Instructions

Wire Stripping Length	15 mm	11 mm	10 mm
Screwdriver	Flat Head 0.8 x 4 mm	Flat Head 0.5 x 3 mm	Flat Head 0.5 x 3 mm

Terminal Blocks

	Cat. No.	Std. Pk.	Cat. No.	Std. Pk.	Cat. No.	Std. Pk.
Grey (standard)	AS6/3	50	ADL2.5(E)D1 ADL2.5(E)D2	50 50	ADLG2.5	50
Red R	AS6/3/R	50			Yellow/Green	
Blue BU	AS6/3/BU	50				
Black BL	AS6/3/BL	50				
Orange O	AS6/3/O	50				
Green G	AS6/3/G	50				
Yellow Y	AS6/3/Y	50				
White W	AS6/3/W	50				

Accessories

	Cat. No.	Std. Pk.	Cat. No.	Std. Pk.	Cat. No.	Std. Pk.
End Plate	EPAS6	50	EPADL2.5	50	EPADLG2.5	50
DIN Rail	2511120 CA701-15/S	20 20	2511120 CA701-15/S	20 20	2511120 CA701-15/S	20 20
End Stop	CA103 CA702 CA802	50 50 50	CA103 CA702 CA802	50 50 50	CA103 CA702 CA802	50 50 50
Jumpers Adjacent	CA801/3	100	CA801/1	100	-	-
Jumpers Alternate	CA801/3-3	100	CA801/1-3	100	-	-
Push in wire jumper	CA901/3	100	CA901/1	100	-	-
Step Down Jumper	AS6 to AS4 AS6 to AS2.5 AS4 to AS2.5 AS6 to AS2.5	CA901/4 CA901/5 - CA801/8	100 100 - 100	- CA901/5 CA901/6 CA901/8	- 100 100 100	- - - -
Marking Tag	MT8	1 Pk. (100 tags)	MT5	1 Pk. (100 tags)	MT2G	1 Pk. (100 tags)

TRIPLE LEVEL ANGULAR SPRING CLAMP



Dimensions & Weight

	ATL2.5	ATL2.5H	ATLG2.5
Width	5 mm	5 mm	5 mm
Length	100 mm	76.1 mm	100 mm
Height w/ DIN Rail	35 x 7.5 mm 35 x 15 mm	75.0 mm 82.5 mm	75.0 mm 82.5 mm
Weight per piece	19.4 g	12.2 g	23.6 g

Technical Data/Ratings

Approvals	UL E220514		IEC 60947-7-1		UL E220514		IEC 60947-7-1	
Wire Size (solid / stranded)	22-12 AWG	0.2-2.5 mm ²	22-12 AWG	0.2-2.5 mm ²	22-12 AWG	0.2-2.5 mm ²	22-12 AWG	0.2-2.5 mm ²
Voltage Rating	600 V	500 V	-	500 V	600 V	500 V	600 V	500 V
Current Rating	20 A	24 A	-	24 A	20 A	24 A	20 A	24 A
Insulation Material	Polyamide 66		Polyamide 66		Polyamide 66		Polyamide 66	

Installation Instructions

Wire Stripping Length	10 mm	10 mm	10 mm
Screwdriver	Flat Head 0.5 x 3 mm	Flat Head 0.5 x 3 mm	Flat Head 0.5 x 3 mm

Terminal Blocks

	Cat. No.	Std. Pk.	Cat. No.	Std. Pk.	Cat. No.	Std. Pk.
Grey (standard)	ATL2.5	100	ATL2.5H	100	ATLG2.5	100
Red R	ATL2.5/R	100	ATL2.5H/R	100	Yellow/Green	
Blue BU	ATL2.5/BU	100	ATL2.5H/BU	100		
Black BL	ATL2.5/BL	100	ATL2.5H/BL	100		
Orange O	ATL2.5/O	100	ATL2.5H/O	100		
Green G	ATL2.5/G	100	ATL2.5H/G	100		
Yellow Y	ATL2.5/Y	100	ATL2.5H/Y	100		
White W	ATL2.5/W	100	ATL2.5H/W	100		

Accessories

	Cat. No.	Std. Pk.	Cat. No.	Std. Pk.	Cat. No.	Std. Pk.
End Plate	EPATL2.5	50	EPATL2.5H	50	EPATLG2.5	50
DIN Rail	2511120 CA701-15/S	20 20	2511120 CA701-15/S	20 20	2511120 CA701-15/S	20 20
End Stop	CA702 CA802 CA202 CA103	50 50 50 50	CA702 CA802 CA202 CA103	50 50 50 50	CA702 CA802 CA202 CA103	50 50 50 50
Push In Jumpers	2 pole CA801/A2 3 pole CA801/A3 4 pole CA801/A4 10 pole CA801/A10	100 100 100 10	2 pole CA801/A2 3 pole CA801/A3 4 pole CA801/A4 10 pole CA801/A10	100 100 100 10	2 pole CA801/A2 3 pole CA801/A3 4 pole CA801/A4 10 pole CA801/A10	100 100 100 10
Marking Tag	MT2G	1 Pk. (100 tags)	MT2G	1 Pk. (100 tags)	MT2G	1 Pk. (100 tags)

ANGULAR SERIES

SPRING TERMINAL BLOCKS

GROUND / EARTH ANGULAR SPRING CLAMP

AGT2.5

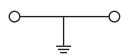

AGT4

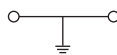

AGT6

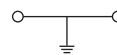

AGT2.5/3

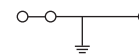

Dimensions & Weight

	2 Connection Ground Terminal Feed-Through	2 Connection Ground Terminal Feed-Through	2 Connection Ground Terminal Feed-Through	3 Connection Ground Terminal Feed-Through
Width	5 mm	6 mm	8 mm	5 mm
Length	54 mm	61.5 mm	74 mm	54 mm
Height w DIN Rail 35 x 7.5 mm 35 x 15 mm	49.5 mm 57 mm	49.5 mm 57 mm	55.5 mm 63 mm	49.5 mm 57 mm
Weight per piece	13.5 g	12.0 g	19.0 g	14.5 g

Technical Data/Ratings

Approvals								
Wire Size (solid / stranded)	22-12 AWG	0.34-2.5 mm ²	22-10 AWG	0.2-4 mm ²	22-10 AWG	0.2-6 mm ²	22-12 AWG	0.34-2.5 mm ²
Voltage Rating	600 V	800V AC/DC	600 V	800V AC/DC	600 V	800V AC/DC	600 V	800V AC/DC
Current Rating	-	-	-	-	-	-	-	-
Insulation Material	Polyamide 66		Polyamide 66		Polyamide 66		Polyamide 66	

Installation Instructions

Wire Stripping Length	11 mm	15 mm	15 mm	12 mm
Screwdriver	Flat Head 0.5 x 3 mm	Flat Head 0.6 x 3.5 mm	Flat Head 0.8 x 4 mm	Flat Head 0.5 x 3 mm

Terminal Blocks

	Cat. No.	Std. Pk.	Cat. No.	Std. Pk.	Cat. No.	Std. Pk.	Cat. No.	Std. Pk.
Yellow/Green	AGT2.5	100	AGT4	100	AGT6	50	AGT2.5/3	100

Accessories

	Cat. No.	Std. Pk.	Cat. No.	Std. Pk.	Cat. No.	Std. Pk.	Cat. No.	Std. Pk.
End Plate	EPAS2.5	50	EPAS4	50	EPAS6	50	EPAS2.5	50
DIN Rail	2511120 CA701-15/S	20 20	2511120 CA701-15/S	20 20	2511120 CA701-15/S	20 20	2511120 CA701-15/S	20 20
Marking Tag	MT5	1 Pk. (100 tags)	MT6	1 Pk. (100 tags)	MT8	1 Pk. (100 tags)	MT5	1 Pk. (100 tags)

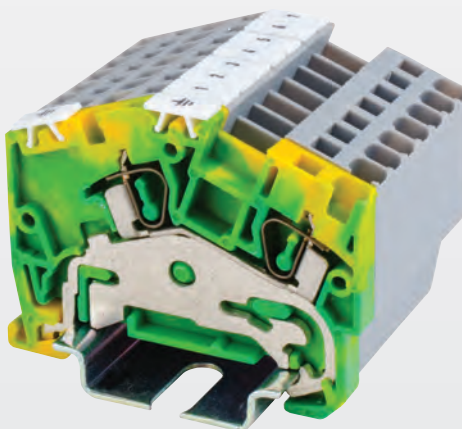

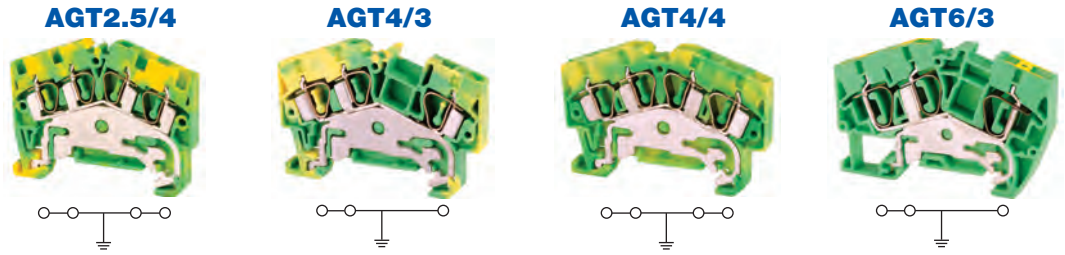

Dimensions & Weight

	4 Connection Ground Terminal Feed-Through	3 Connection Ground Terminal Feed-Through	4 Connection Ground Terminal Feed-Through	3 Connection Ground Terminal Feed-Through
Width	5 mm	6 mm	6 mm	8 mm
Length	54 mm	61.5 mm	61.5 mm	74 mm
Height w DIN Rail	35 x 7.5 mm 35 x 15 mm	44.0 mm 51.6 mm	44.0 mm 51.6 mm	49.3 mm 57.0 mm
Weight per piece	15.5 g	14.5 g	18.6 g	22.0 g

Technical Data/Ratings

Approvals								
Wire Size (solid / stranded)	22-12 AWG	0.34-2.5 mm ²	22-10 AWG	0.2-4 mm ²	22-10 AWG	0.2-4 mm ²	22-8 AWG	0.2-6 mm ²
Voltage Rating	600 V	800V AC/DC	600 V	800V AC/DC	600 V	800V AC/DC	600 V	800V AC/DC
Current Rating	-	-	-	-	-	-	-	-
Insulation Material	Polyamide 66		Polyamide 66		Polyamide 66		Polyamide 66	

Installation Instructions

Wire Stripping Length	12 mm	15 mm	15 mm	15 mm
Screwdriver	Flat Head 0.5 x 3 mm	Flat Head 0.6 x 3.5 mm	Flat Head 0.6 x 3.5 mm	Flat Head 0.8 x 4 mm

Terminal Blocks

	Cat. No.	Std. Pk.	Cat. No.	Std. Pk.	Cat. No.	Std. Pk.	Cat. No.	Std. Pk.
Yellow/Green	AGT2.5/4	100	AGT4/3	100	AGT4/4	50	AGT6/3	100

Accessories

	Cat. No.	Std. Pk.	Cat. No.	Std. Pk.	Cat. No.	Std. Pk.	Cat. No.	Std. Pk.
End Plate	EPAS2.5	50	EPAS4	50	EPAS4	50	EPAS6	50
DIN Rail	2511120 CA701-15/S	20 20	2511120 CA701-15/S	20 20	2511120 CA701-15/S	20 20	2511120 CA701-15/S	20 20
Marking Tag	MT5	1 Pk. (100 tags)	MT6	1 Pk. (100 tags)	MT6	1 Pk. (100 tags)	MT8	1 Pk. (100 tags)

CX SERIES



Terminal Block Series	Poles	Cat. No.	Std. Pk.
	2 Pole	JX2.5/2	100
CX2.5 Series	3 Pole	JX2.5/3	50
CXG2.5 Series	4 Pole	JX2.5/4	50
CXDL2.5	5 Pole	JX2.5/5	50
CXK2.5	6 Pole	JX2.5/6	10
CXS2.5	7 Pole	JX2.5/7	10
	8 Pole	JX2.5/8	10
	10 Pole	JX2.5/10	10

CX4 Series	2 Pole	JX4/2	100
CXG4 Series	3 Pole	JX4/3	50
CXF4	4 Pole	JX4/4	50
CXCC4	8 Pole	JX4/8	10
CXS4	10 Pole	JX4/10	10
	16 Pole	JX4/16	10

CX6 Series	2 Pole	JX6/2	100
CXG6 Series	3 Pole	JX6/3	50
CXDB35/10	4 Pole	JX6/4	50
	10 Pole	JX6/10	10

CX10 Series	2 Pole	JX10/2	20
CXG10 Series			

Push-In Technology Multipole Jumpers

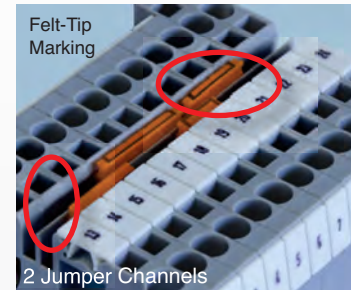
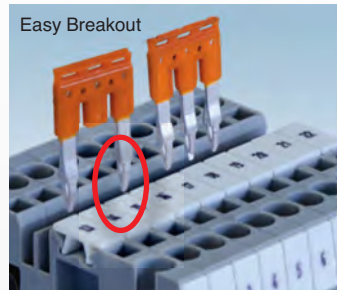
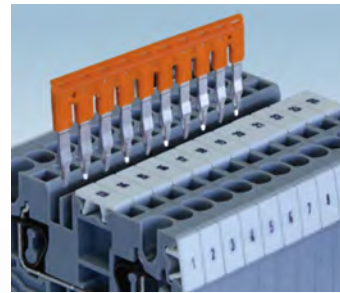

ANGULAR SERIES

2 Pole Adjacent Jumper



Alternate Jumper



Push-In Wire Jumper



Terminal Block Series	Cat. No.	Std. Pk.	Cat. No.	Std. Pk.	Cat. No.	Std. Pk.
AS2.5 / ADL2.5 Series	CA801/1	100	CA801/1-3	100	CA901/1	100
AS4 Series	CA801/2	100	CA801/2-3	100	CA901/2	100
AS6 Series	CA801/3	100	CA801/3-3	100	CA901/3	100

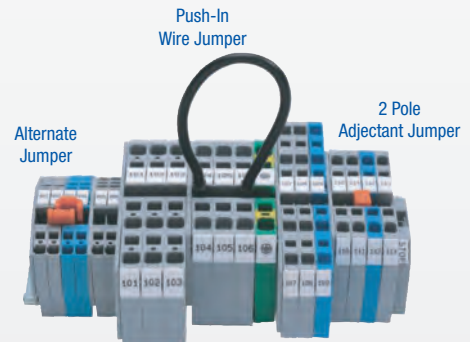

STEP DOWN JUMPERS

Used for jumpering terminal blocks of different sizes.

CX SERIES



Jumper for	Cat. No.	Std. Pk.
CX10 to CX2.5	JXS10/2.5	50
CX6 to CX2.5	JXS6/2.5	50
CX10 to CX4	JXS10/4	50
CX6 to CX4	JXS6/4	50

ANGULAR SERIES



Jumper for	Cat. No.	Std. Pk.
AS6 to AS2.5	CA901/5	100
AS6 to AS4	CA901/4	100
AS4 to AS2.5	CA901/6	100

ENDPLATES

CX SERIES



Terminal Block	Cat. No.	Dimensions	Std. Pk.
CX2.5 CXG2.5	EPCX2.5	30.5 x 49.7 x 1.5mm	50
CX4 CXG4	EPCX4	30.5 x 54.8 x 1.5mm	50
CX6 CXG6	EPCX6	35.3 x 62.1 x 1.5mm	50
CX10 CXG10	EPCX10	41.6 x 70 x 1.5mm	50
CX2.5/3 CXG2.5/3 CXK2.5	EPCX2.5/3	30.5 x 62.2 x 1.5mm	50
CX2.5/4 CXG2.5/4	EPCX2.5/4	30.5 x 74.7 x 1.5mm	50
CX4/3 CXG4/3 CXK4	EPCX4/3	30.5 x 70.5 x 1.5mm	50
CX4/4 CXG4/4	EPCX4/4	30.5 x 86.2 x 1.5mm	50
CX6/3 CXG6/3	EPCX6/3	35.3 x 82.2 x 1.5mm	50
CX10/3 CXG10/3	EPCX10/3	41.6 x 95.3 x 1.5mm	50
CXDL2.5 CXDLG2.5	EPCXDL2.5	41.8 x 72.7 x 1.5mm	50
CXS2.5	EPCXS2.5	35.6 x 43 x 1.5mm	50
CXS4	EPCXS4		50

PARTITION PLATES



CX SERIES

Terminal Block	Cat. No.	Dimensions	Std. Pk.
CX2.5, CXG2.5 CX4, CXG4	PPCX4	42.4 x 59 x 2mm	50
CX2.5/3, CXG2.5/3 CX4/3, CXK2.5	PPCX4/3	42.4 x 74.7 x 2mm	50
CX2.5/4, CXG2.5/4 CX4/4, CXK4/4	PPCX4/4	42.4 x 95 x 2mm	50
CX6, CX10	PPCX6	53.5 x 76 x 1mm	50

ANGULAR SERIES



Terminal Block	Cat. No.	Dimensions	Std. Pk.
AS2.5 AS2.5/XX AGT2.5 AGT2.5/XX	EPAS2.5	35 x 54 x 1.5mm	50
AS4 AS4/XX AGT4 AGT4/XX	EPAS4	27.5 x 61 x 1.5mm	50
AS6 AS6/XX AGT6 AGT6/XX	EPAS6	33.5 x 74 x 1.5mm	50
ADL2.5	EPADL2.5	43.5 x 80 x 1.5mm	50
ADLG2.5	EPADLG2.5	83.7 x 58 x 1.2mm	50
ATL2.5	EPATL2.5	100 x 69.7 x 1.2mm	50
ATL2.5H	EPATL2.5H	77.3 x 69.7 x 1.2mm	50
ATLG2.5	EPATLG2.5	100 x 68.7 x 1.2mm	50

END STOPS

CA103



Screwless
Snap On

Cat. No.	Dimensions	Std. Pk.
CA103	35 x 41 x 6mm	50

CA802



CA702



Cat. No.	Dimensions	Std. Pk.	Cat. No.	Dimensions	Std. Pk.
CA802	32 x 45 x 8mm	50	CA702	34 x 45 x 9mm	50

TEST PLUGS

Terminal Block	Cat. No.	Std. Pk.
CX2.5, CXG2.5, CXDL2.5, CXG4, CXM2.5, CXMG2.5	TX2.5	20
CX4, CXG4, CX7, CXG6	TX4	20
CX6, CXDB	TX6	20



SCREW CLAMP TECHNOLOGY

- Screw clamp & Spring Clamp Technology versions
- Extremely Compact wiring solution
- 15mm Mini Rail Terminals
- Modular easy snap together Panel Mount Terminals
- High Temperature Ceramic Solution
- Reliable Gas-tight connection



MATERIAL SPECIFICATIONS

Current Carrying Metal



Screw Terminals
Corrosion free material

- Clamp: Zinc Plated Steel
- Screw: Steel
- Current Bar: Brass/
Tin Plated Copper



Spring Terminals
Corrosion free material

- Spring: Stainless Steel
- Current Bar: Copper Alloy

Terminal Block Housing

- Polyamide PA66 Housing
- Self-extinguishing
- High mechanical strength

Polyamide 66 Specifications

Upper Temperature Limit:	105°C
Lower Temperature Limit:	-50°C
Flammability UL94:	V2/ V0
Volume Resistivity:	10 ¹² Ω cm
Surface Resistivity:	10 ¹⁰ Ω

SELECTION GUIDE

Screw Terminal Blocks

- Extremely Compact size
- Various mounting options
 - 15mm Mini Rail
 - Panel Mount
- Modular system
- Jumper Accessories
- Screw Clamp Technology



**15mm Mini Rail
CMT4**
page 89



**Panel Mount
CMB4**
page 90

Spring Clamp Terminal Blocks

- Extremely Compact size
- Various mounting options
 - 15mm Mini Rail
 - Panel Mount
- Modular Snap together Systems
- Spring Clamp Technology



**15mm Mini Rail
CXM2.5**
page 91



**Panel/DIN Rail
CSCP Series**
page 92

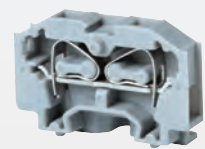

**Panel Mount
CM Series**
page 93

High Temperature Ceramic Terminal Blocks

- High Temperatures up to 600°C
- Ceramic Material
- 3 sizes
- Up to 65A/ 300V
- Free floating or mounting hole option



**High Temperature
CB Series**
page 94



Dimensions & Weight

	CMT4	CGMT4	CF4U
	2 Connection Feed-Through Internal Jumper Provision	2 Connection Ground Terminal Internal Jumper Provision	5 x 20 mm Fuse Terminal
Width	6 mm	6 mm	8 mm
Length	27 mm	27 mm	57.0 mm
Height w DIN15 Rail 15mm	30.4 mm	30.7 mm	50.3 mm 57.6 mm
Weight per piece	5.5 g	9.5 g	14.8 g

Technical Data/Ratings

Approvals	 E220514 C-SP US 60947-7-1		 E220514 60947-7-1		 E220514 C-SP US 60947-7-3	
Wire Size (solid / stranded)	22-10 AWG 0.2-4 mm ²		22-10 AWG 0.2-4 mm ²		22-10 AWG 0.2-4 mm ²	
Voltage Rating	300 V 500 V AC/DC		300 V 500 V AC/DC		600 V	800 V AC/DC
Current Rating	35 A 32 A		-		10 A	6.3 A
Torque	7 lb-in 0.5 Nm		7 lb-in 0.8 Nm		7 lb-in	0.5 Nm
Insulation Material	Polyamide 66		Polyamide 66		Polyamide 66	

Installation Instructions

Wire Stripping Length	8 mm	8 mm	9.5 mm
Screwdriver	Flat Head 0.6 x 3.5 mm	Flat Head 0.6 x 3.5 mm	Flat Head 0.6 x 3.5 mm

Terminal Blocks

	Cat. No.	Std. Pk.	Cat. No.	Std. Pk.	Cat. No.	Std. Pk.
Grey (standard)	CMT4	100	CGMT4	100	CF4U	50
Red R	CMT4/R	100	Yellow/Green		CF4U/BU	50
Blue BU	CMT4/BU	100			CF4U/BL	50
Black BL	CMT4/BL	100				
Orange O	CMT4/O	100				
Green G	CMT4/G	100				
Yellow Y	CMT4/Y	100				
White W	CMT4/W	100				

Accessories

	Cat. No.	Std. Pk.	Cat. No.	Std. Pk.	Cat. No.	Std. Pk.
End Plate	EPCMT4	50	-	-	-	-
Isolation Partition	PPCMT4	50	-	-	-	-
DIN Rail	CA601/S	50	CA601/S	50	CA601/S	50
End Clamp	CA602	100	CA602	100	-	-
Internal Jumper	2 pole CA727/2	100	-	-	-	-
3 pole CA727/3	100	-	-	-	-	-
4 pole CA727/4	100	-	-	-	-	-
10 pole CA727/10	10	-	-	-	-	-
Insulated Internal Jumper	2 pole CA747/2	100	-	-	-	-
3 pole CA747/3	100	-	-	-	-	-
4 pole CA747/4	100	-	-	-	-	-
10 pole CA747/10	10	-	-	-	-	-
External Jumper	2 pole CA714/2	100	CA714/2	100	CA711/2	100
3 pole CA714/3	100	CA714/3	100	CA711/3	50	
4 pole CA714/4	100	CA714/4	100	CA711/4	50	
10 pole CA714/10	20	CA714/10	20	CA711/10	20	
Test Socket	CA707/TS/03	100	CA707/TS/03	-	-	-
Marking Tag	MT2	1 Pk. (100 tags)	MT2	1 Pk. (100 tags)	MT8	1 Pk. (100 tags)
					MT6	1 Pk. (100 tags)

HIGHLIGHTS

FEATURES

- Extremely Compact Size
- Screw Cage Clamp
- Mountable on DIN15 Mini Rail
- Feed Through Terminal
- Ground Terminal
- Internal Jumper possibility
- EX / IECEx approved

APPLICATIONS

- Limited Space Panels
- High Density Wiring Solutions

PANEL MOUNT CMB SERIES

MINI / PANEL MOUNT TERMINALS

PANEL MOUNT SCREW TERMINAL BLOCKS

HIGHLIGHTS

FEATURES

- Extremely Compact Size
- Screw Cage Clamp
- Panel Mountable with any length M3 screw
- End / Mounting Section with M3 mounting holes
- Stackable design for flexible length configurations
- Modular snap-together design for quick assembly and installation
- Endplates with mounting holes
- Internal Jumper possibility
- EX / IECEx approved
- Pre-assembled Blocks available in all pole configurations and various colors

APPLICATIONS

- Cost Effective Wiring Solutions
- Compact Wiring Solutions
- Panel Mount Designs
- High Density Wiring

CMB4



2 Connection Feed Through

Dimensions & Weight

Width	6 mm
Length	27 mm
Height	28 mm
Weight per piece	5.5 g

Technical Data/Ratings

Approvals	
Wire Size (solid / stranded)	22-10 AWG 0.2-4 mm ²
Voltage Rating	300 V 500 V AC/DC
Current Rating	35 A 32 A
Torque	7 lb-in 0.5 Nm
Insulation Material	Polyamide 66

Installation Instructions

Wire Stripping Length	8 mm
Screwdriver	Flat Head 0.6 x 3.5mm
Mounting Screw	Any length M3 screw may be used

Terminal Blocks

	Cat. No.	Std. Pk.
Grey (standard)	CMB4	100
Red R	CMB4/R	100
Blue BU	CMB4/BU	100
Black BL	CMB4/BL	100
Orange O	CMB4/O	100
Green G	CMB4/G	100
Yellow Y	CMB4/Y	100
White W	CMB4/W	100

Accessories

	Cat. No.	Std. Pk.
End / Mounting Section	EPCMB4	50
Separator Plate	SPCMB4	50
Internal Jumper	2 pole CA727/2	100
	3 pole CA727/3	100
	4 pole CA727/4	100
	10 pole CA727/10	10
Insulated Internal Jumper	2 pole CA747/2	100
	3 pole CA747/3	100
	4 pole CA747/4	100
	10 pole CA747/10	10
External Jumper	2 pole CA714/2	100
	3 pole CA714/3	100
	4 pole CA714/4	100
	10 pole CA714/10	20
Test Socket	CA707/TS/O1	100
Marking Tag	MT2	1 Pk. (100 tags)

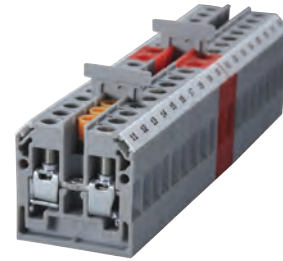

Pre-assembled Terminal Blocks

No. of Poles	Cat. No	Total Width (a)	Hole Spacing (b)
2	CMB4/2	26 mm (1.02")	19 mm (0.75")
3	CMB4/3	32 mm (1.26")	25 mm (0.98")
4	CMB4/4	38 mm (1.50")	31 mm (1.22")
5	CMB4/5	44 mm (1.73")	37 mm (1.46")
6	CMB4/6	50 mm (1.97")	43 mm (1.69")
7	CMB4/7	56 mm (2.20")	49 mm (1.93")
8	CMB4/8	62 mm (2.44")	55 mm (2.17")
9	CMB4/9	68 mm (2.68")	61 mm (2.40")
10	CMB4/10	74 mm (2.91")	67 mm (2.64")
11	CMB4/11	80 mm (3.15")	73 mm (2.87")
12	CMB4/12	86 mm (3.39")	79 mm (3.11")
13	CMB4/13	92 mm (3.62")	85 mm (3.35")
14	CMB4/14	98 mm (3.86")	91 mm (3.58")
15	CMB4/15	104 mm (4.09")	97 mm (3.82")
16	CMB4/16	110 mm (4.33")	103 mm (4.06")
17	CMB4/17	116 mm (4.57")	109 mm (4.29")
18	CMB4/18	122 mm (4.80")	115 mm (4.53")
19	CMB4/19	128 mm (5.04")	121 mm (4.76")
20	CMB4/20	134 mm (5.28")	127 mm (5.00")
21	CMB4/21	140 mm (5.51")	133 mm (5.24")
22	CMB4/22	146 mm (5.75")	139 mm (5.47")
23	CMB4/23	152 mm (5.98")	145 mm (5.71")
24	CMB4/24	158 mm (6.22")	151 mm (5.94")

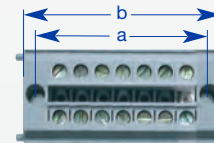

Dimensions CMB4

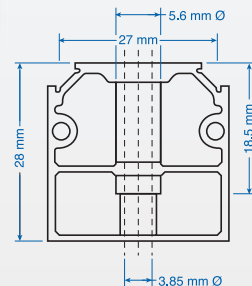

Mounting Section Dimensions EPCMB4

4 Pole Internal Jumper CA727/4

CMB4 Terminal Block

End / Mounting Section EPCMB4

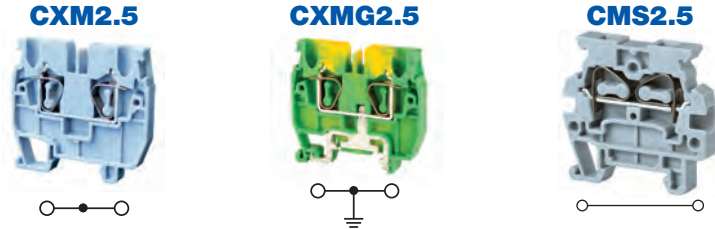

Dimensions & Weight

	CXM2.5	CXMG2.5	CMS2.5
	2 Connection Feed Through 2 Jumper Channels	2 Connection Ground Terminal 2 Jumper Channels	Side Entry Feed Through
Width	5 mm	5 mm	5 mm
Length	37 mm	37 mm	31 mm
Height w DIN Rail 15 x 5.5 mm	35 mm	35 mm	30.15 mm
Weight per piece	5.9 g	10.3 g	5.9 g

Technical Data/Ratings

Approvals						
Wire Size (solid / stranded)	24-12 AWG	0.2-2.5 mm ²	24-12 AWG	0.2-2.5 mm ²	24-12 AWG	0.2-2.5 mm ²
Voltage Rating	600 V	1000V AC/DC	600 V	1000V AC/DC	300 V	800V AC/DC
Current Rating	20 A	24 A	-	-	20 A	24 A
Insulation Material	Polyamide 66		Polyamide 66		Polyamide 66	

Installation Instructions

Wire Stripping Length	10 mm	10 mm	9 mm
Screwdriver	Flat Head 0.5 x 3 mm	Flat Head 0.5 x 3 mm	Flat Head 0.5 x 3 mm

Terminal Blocks

	Cat. No.	Std. Pk.	Cat. No.	Std. Pk.	Cat. No.	Std. Pk.
Grey (standard)	CXM2.5	100	CXMG2.5	100	CMS2.5	100
Red R	CXM2.5/R	100	Yellow/Green		CMS2.5/R	100
Blue BU	CXM2.5/BU	100			CMS2.5/BU	100
Black BL	CXM2.5/BL	100			CMS2.5/BL	100
Orange O	CXM2.5/O	100			CMS2.5/O	100
Green G	CXM2.5/G	100			CMS2.5/G	100
Yellow Y	CXM2.5/Y	100			CMS2.5/Y	100
White W	CXM2.5/W	100			CMS2.5/W	100

Accessories

	Cat. No.	Std. Pk.	Cat. No.	Std. Pk.	Cat. No.	Std. Pk.
End Plate	EPCXM2.5	50	EPCXM2.5	50	EPCMS2.5	50
DIN Rail	CA601/S	50	CA601/S	50	CA601/S	50
End Clamp	CA602	100	CA602	100	CA602	100
Jumper	2 pole JX2.5/2	100	2 pole JX2.5/2	100	-	-
3 pole JX2.5/3	50	3 pole JX2.5/3	50	-	-	
4 pole JX2.5/4	50	4 pole JX2.5/4	50	-	-	
5 pole JX2.5/5	50	5 pole JX2.5/5	50	-	-	
6 pole JX2.5/6	10	6 pole JX2.5/6	10	-	-	
7 pole JX2.5/7	10	7 pole JX2.5/7	10	-	-	
8 pole JX2.5/8	10	8 pole JX2.5/8	10	-	-	
10 pole JX2.5/10	10	10 pole JX2.5/10	10	-	-	
Spring Clamp Actuator	SCA2-5	1	SCA2-5	1	-	-
Marking Tag	MT5	1 Pk. (100 tags)	MT5	1 Pk. (100 tags)	MT5	1 Pk. (100 tags)

Operating Tool
for use with
CXM2.5



HIGHLIGHTS

FEATURES

- Extremely Compact Size
- Spring Clamp Style
- Mountable on DIN 15 Mini Rail
- Feed Through Terminal
- Ground Terminal
- Side Entry Feed Through
- 2, 3, 4, 5, 6, 7, 10 pole Push-In Jumpers
- EX / IECEx approved

APPLICATIONS

- Limited Space Panels
- High Density Wiring Solutions
- Machine Control Panels
- High Vibration Applications

PANEL MOUNT CSCP SERIES

MINI / PANEL MOUNT TERMINALS

PANEL MOUNT SPRING TERMINAL BLOCKS

HIGHLIGHTS

FEATURES

- Extremely Compact Size
- Screw Cage Clamp
- Panel Mountable with any screw
- Endplates with screw flange
- Stackable design for flexible length configurations
- Modular snap-together design for quick assembly and easy installation
- External Jumper possibility
- EX / IECEx approved
- Custom assemblies available in all pole configurations and various colors

APPLICATIONS

- Cost Effective Panel Mount Designs
- Limited Space Panels
- High Density Wiring Solutions
- Machine Control Panels
- High Vibration Applications

CSCP2.5T



2 Connection Spring Terminal Panel Mount

CSCP2.5T2

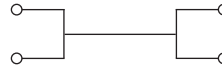

4 Connection Spring Terminal Panel Mount

CXCP2.5/4

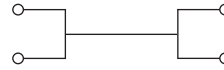

4 Connection Spring Terminal DIN Rail Mount

Dimensions & Weight

Width	5 mm	10 mm	10 mm
Length	35 mm	35 mm	35 mm
Height w DIN Rail	35 x 7.5 mm 35 x 15 mm	21.3 mm (Panel Mount)	34.5 mm 42 mm
Weight per piece	5.0 g	9.5 g	9.5 g

Technical Data/Ratings

Approvals						
Wire Size (solid / stranded)	22-14 AWG	0.2-2.5 mm ²	22-14 AWG	0.2-2.5 mm ²	22-12 AWG	0.2-2.5 mm ²
Voltage Rating	600 V	800 V AC/DC	600 V	800 V AC/DC	600 V	800 V AC/DC
Current Rating	20 A	24 A	20 A	24 A	20 A	24 A
Insulation Material	Polyamide 66		Polyamide 66		Polyamide 66	

Installation Instructions

Wire Stripping Length	11 mm	11 mm	10 mm
Screwdriver	Flat Head 0.5 x 3 mm	Flat Head 0.5 x 3 mm	Flat Head 0.5 x 3 mm
Mounting Screw	Any length M3 screw may be used	Any length M3 screw may be used	-

Terminal Blocks

	Cat. No.	Std. Pk.	Cat. No.	Std. Pk.	Cat. No.	Std. Pk.
Grey (standard)	CSCP2.5T	100	CSCP2.5T2	100	CXCP2.5/4	100
Red R	CSCP2.5T/R	100	CSCP2.5T2/R	100	CXCP2.5/4/R	100
Blue BU	CSCP2.5T/BU	100	CSCP2.5T2/BU	100	CXCP2.5/4/BU	100
Black BL	CSCP2.5T/BL	100	CSCP2.5T2/BL	100	CXCP2.5/4/BL	100
Orange O	CSCP2.5T/O	100	CSCP2.5T2/O	100	CXCP2.5/4/O	100
Green G	CSCP2.5T/G	100	CSCP2.5T2/G	100	CXCP2.5/4/G	100
Yellow Y	CSCP2.5T/Y	100	CSCP2.5T2/Y	100	CXCP2.5/4/Y	100
White W	CSCP2.5T/W	100	CSCP2.5T2/W	100	CXCP2.5/4/W	100

Operating Tool
for use with
CSCP2.5T2



Custom
Assembly
Example



Accessories

	Cat. No.	Std. Pk.	Cat. No.	Std. Pk.	Cat. No.	Std. Pk.
End Section	EPCSCP2.5T	25	EPCSCP2.5T	25	EPCXCP2.5	25
Insulated Jumpers (2 pole)	CA803/1	100	CA803/1	100	CA803/1	100
Marking Tag	MT4	1 Pk. (100 tags)	MT3	1 Pk. (100 tags)	MT3	1 Pk. (100 tags)
Operating Tool	SCA2-5	1	SCA2-5	1	SCA2-5	1

PANEL MOUNT

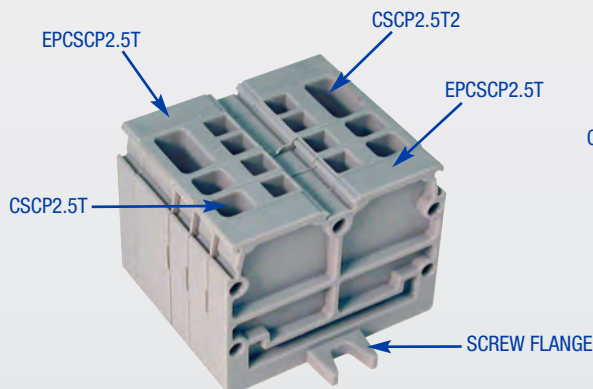

DIN RAIL MOUNT

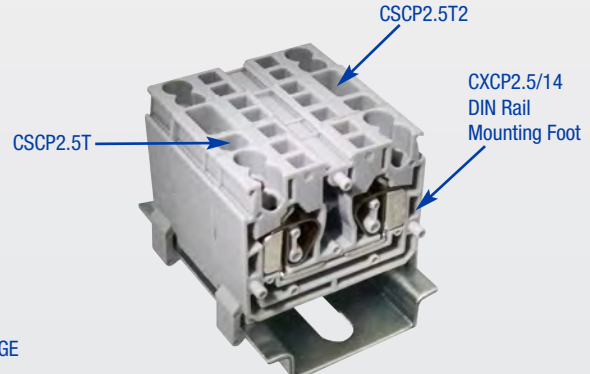

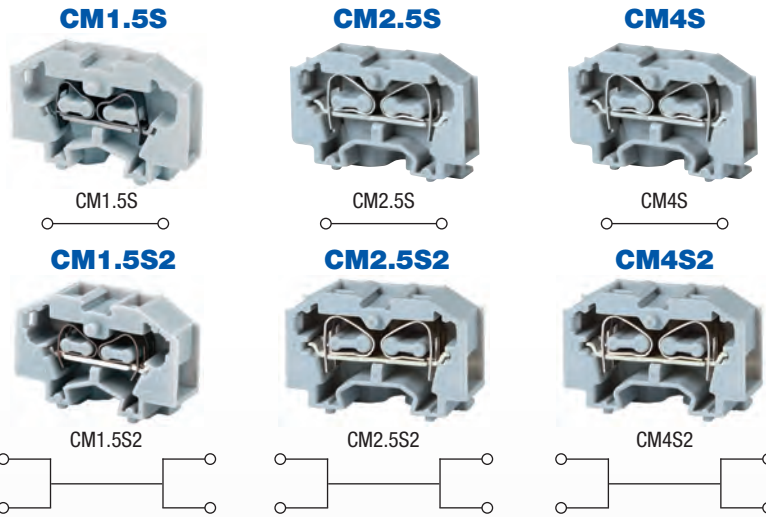

Dimensions

Width	2 Connection	5 mm	6 mm	7 mm
	4 Connection	8 mm	10 mm	12 mm
Length		26.5 mm	30.0 mm	33.7 mm
Height (Panel Mount)		18.0 mm	20.0 mm	23.0mm
Weight per piece		1.8 / 3.8 g	3.2 / 5.2 g	g

Technical Data/Ratings

Approvals						
Wire Size (solid / stranded)	24-16 AWG / 0.2-1.5 mm ²		22-12 AWG / 0.2-2.5 mm ²		22-14 AWG / 0.2-4 mm ²	
Voltage Rating	300 V / 500V AC/DC		300 V / 500V AC/DC		300 V / 630V AC/DC	
Current Rating	10 A / 17 A		20 A / 24 A		26 A / 32 A	
Insulation Material	Polyamide 66					

Installation Instructions

Wire Stripping Length	8 mm	9 mm	8 mm
Screwdriver	Flat Head 0.5 x 3 mm	Flat Head 0.5 x 3 mm	Flat Head 0.6 x 3.5 mm

Terminal Blocks

2 Connections

	Cat. No.	Std. Pk.	Cat. No.	Std. Pk.	Cat. No.	Std. Pk.
Grey (standard)	CM1.5S	100	CM2.5S	100	CM4S	100
Red R	CM1.5S/R	100	CM2.5S/R	100	CM4S/R	100
Blue BU	CM1.5S/BU	100	CM2.5S/BU	100	CM4S/BU	100
Black BL	CM1.5S/BL	100	CM2.5S/BL	100	CM4S/BL	100
Orange O	CM1.5S/O	100	CM2.5S/O	100	CM4S/O	100
Green G	CM1.5S/G	100	CM2.5S/G	100	CM4S/G	100
Yellow Y	CM1.5S/Y	100	CM2.5S/Y	100	CM4S/Y	100
White W	CM1.5S/W	100	CM2.5S/W	100	CM4S/W	100

4 Connections

	Cat. No.	Std. Pk.	Cat. No.	Std. Pk.	Cat. No.	Std. Pk.
Grey (standard)	CM1.5S2	100	CM2.5S2	100	CM4S2	100
Red R	CM1.5S2/R	100	CM2.5S2/R	100	CM4S2/R	100
Blue BU	CM1.5S2/BU	100	CM2.5S2/BU	100	CM4S2/BU	100
Black BL	CM1.5S2/BL	100	CM2.5S2/BL	100	CM4S2/BL	100
Orange O	CM1.5S2/O	100	CM2.5S2/O	100	CM4S2/O	100
Green G	CM1.5S2/G	100	CM2.5S2/G	100	CM4S2/G	100
Yellow Y	CM1.5S2/Y	100	CM2.5S2/Y	100	CM4S2/Y	100
White W	CM1.5S2/W	100	CM2.5S2/W	100	CM4S2/W	100

Accessories

	Cat. No.	Std. Pk.	Cat. No.	Std. Pk.	Cat. No.	Std. Pk.
End Plate	EPCM1.5S	50	EPCM2.5S	50	EPCM4S	50
Spring Clamp Actuator	SCA2-5	1	SCA2-5	1	SCA2-5	1
Marking Tag	2 Connection	MT4	1 Pk. (100 tags)	2 Connection	MT2	1 Pk. (100 tags)
	4 Connection	MT7.5	1 Pk. (100 tags)	4 Connection	MT7.5	1 Pk. (100 tags)

HIGHLIGHTS

FEATURES

- Extremely Compact Size
- Spring Clamp Style
- End Sections with screw flanges
- 3 wire sizes
- 2, 4 connection terminals
- All colors

APPLICATIONS

- Transformer Terminal Blocks
- Very Limited Space Applications
- Machine Control Panels



HIGHLIGHTS

FEATURES

- Suitable for High Temperatures up to 600°C (1112°F)
- Temperature Rating -40°C - 600°C
- 3 Sizes
- 1, 2, 3, 4 Pole configurations
- Free floating or Panel Mount
- Up to 65A
- Material:
 - Housing: Steatite
 - Clamp: Brass
 - Screws: Zinc Plated Steel

APPLICATIONS

- High Temperature Environments
- Furnaces
- Heaters
- Process Equipment
- Machinery

CB4



CB6



CB16



Technical Data/Ratings

Approvals									
Wire Size (solid / stranded)	24-12 AWG	24-12 AWG	0.5-2.5mm ²	22-10 AWG	22-10 AWG	0.5-4mm ²	18-6 AWG	20-6 AWG	0.5-2.5mm ²
Voltage Rating	300 V	300 V	800 VAC/DC	300 V	300 V	800 VAC/DC	300 V	300 V	800 VAC/DC
Current Rating	20 A	30 A	24 A	30 A	40 A	32 A	65 A	76 A	57 A
Torque	6 lb-in	6 lb-in	0.4Nm	6 lb-in	6 lb-in	0.5Nm	12 lb-in	12 lb-in	1.2Nm
Insulation Material	Ceramic			Ceramic			Ceramic		

Installation Instructions

Wire Stripping Length	8 mm	8 mm	8 mm
Screwdriver	Flat Head 0.5 x 3 mm	Flat Head 0.8 x 4 mm	Flat Head 0.8 x 4 mm
Mounting Hole Size	3.5 mm	3.5 mm	3.5 mm
Recommended Mounting Screw	M3 x 16	M3 x 16	M3 x 20

Terminal Blocks

		Cat. No.	Std. Pk.	Weight	Cat. No.	Std. Pk.	Weight	Cat. No.	Std. Pk.	Weight
1 pole	free floating	CB4/1	50	11.7 g	CB6/1	50	13.5 g	-	-	-
2 pole	free floating	CB4/2	50	18.0 g	-	-	-	-	-	-
	with mounting holes	CB4/2H	50	26.1 g	CB6/2H	50	27.3 g	CB16/2H	50	47.2 g
3 pole	free floating	CB4/3	50	30.1 g	-	-	-	-	-	-
	with mounting holes	CB4/3H	50	42.3 g	CB6/3H	50	42.5 g	CB16/3H	50	44.6 g
4 pole	with mounting holes	-	-	-	CB6/4H	50	29.1 g	-	-	-

Dimensions (All dimensions are shown in mm, to convert to inches please divide by 25.4)

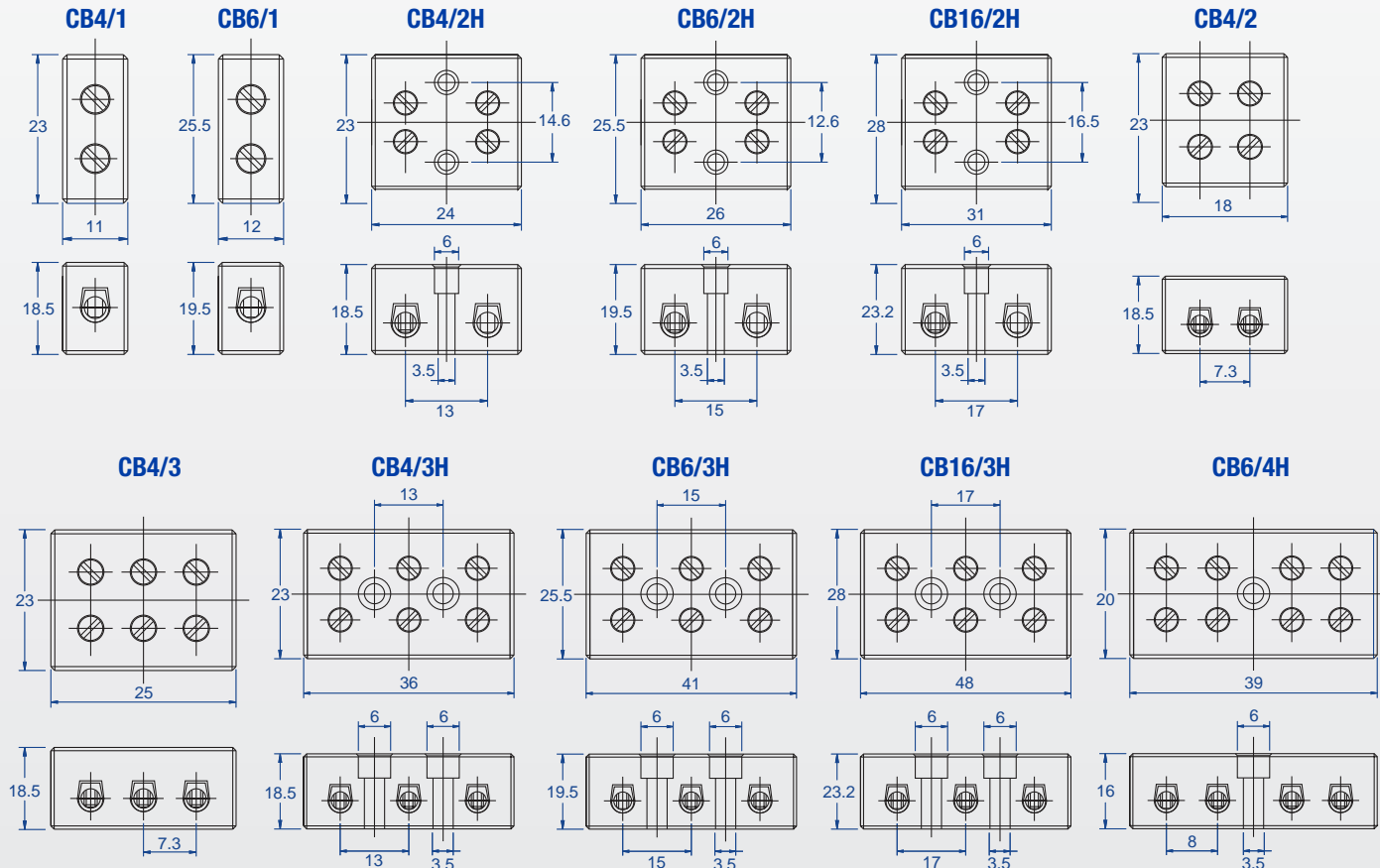

OVERVIEW

SCREW CLAMP CONNECTION TECHNOLOGY

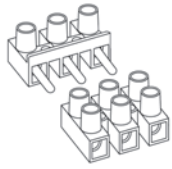

- Quick and Efficient Wire-to-Wire connection solution
- Modern Replacement for traditional Double-Row Barrier Style Terminal Blocks
- Touch-proof design to eliminate shorts
- Available in 12 poles or precut to required number of poles
- Easy to cut to length by using hacksaw or utility knife
- Safe, Gas-tight connection
- Reliable connection utilizing a precision machined tubular screw clamp insert
- Accessories for convenient wire installation and usage



SELECTION GUIDE

HE SERIES with wire protector

MATERIAL SPECIFICATIONS

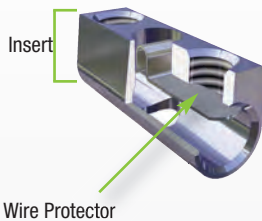

Current Carrying Metal
Corrosion free material

- Insert: Tinned Brass
- Screw: Blue chromated steel
- Wire protector: Stainless Steel

Terminal Block Housing

- Polyamide PA66 Housing
- Self-extinguishing
- High mechanical strength

Polyamide 66 Specifications

- Upper Temperature Limit: 125°C
- Lower Temperature Limit: -30°C
- Flammability UL94: V0



HE Series Flat Base 300V
page 96-97



HEH Series Standoff Feet 600V
page 98-99

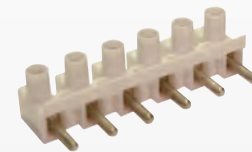

HE42 Series Pluggable 300V, 600V
page 100-101

ATS SERIES with wire protector - Center Barrier

MATERIAL SPECIFICATIONS

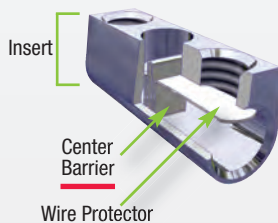

Current Carrying Metal
Corrosion free material

- Insert: Nickel-plated copper alloy
- Screw: yellow chromated steel
- Wire protector: Stainless Steel
- Middle Barrier: Stainless Steel

Terminal Block Housing

- Polyamide PA66 Housing
- Self-extinguishing
- High mechanical strength

Polyamide 66 Specifications

- Upper Temperature Limit: 125°C
- Lower Temperature Limit: -30°C
- Flammability UL94: V0



ATS Series Flat Base 300V
page 102



ATSF Series Standoff Feet 600V
page 103

ACCESSORIES



Jumpers, Separation Plates, Marking Pins, Imprinting
page 104-105

HIGHLIGHTS

FEATURES

- 300V up to 63A
- Cost effective reliable wire-to-wire solution
- Easy to use double-row terminal strips
- Panel mount or free float
- Finger safe metal parts
- Wire protector
- easy to cut to required pole configuration
- Pre cut version in stock
- Color: white

APPLICATIONS

- HVAC
- Appliances
- Equipment
- Power Distribution
- Junction Boxes
- Cost effective alternative to barrier strips



Dimensions & Weight

Pitch Spacing	8 mm	10 mm
Weight per piece (12 pole)	16.2 g	31.6 g

Technical Data/Ratings

Approvals				
	24-12 AWG		1-2.5 mm ²	
Wire Size (solid / stranded)	300 V	400 V	300 V	400 V
Voltage Rating	20 A	6 A	30 A	10 A
Current Rating	4.4 lb-in	0.35 Nm	7.0 lb-in	0.4 Nm
Torque	Polyamide 66/6 V0		Polyamide 66/6 V0	
Insulation Material	Tinned Brass		Tinned Brass	
Insert Material	Blue Chromated Steel		Blue Chromated Steel	
Terminal Screw Material	5 mm		6 mm	
Wire Stripping Length	3.0 mm		3.6 mm	
Mounting Hole Diameter	M2.6		M3	
Terminal Screw Size	2 pole		16.4 mm	
Terminal Strips	3 pole		26.4 mm	
	4 pole		36.4 mm	
Terminal Strips	5 pole		46.4 mm	
	6 pole		56.4 mm	
Terminal Strips	7 pole		66.4 mm	
	8 pole		76.4 mm	
Terminal Strips	9 pole		86.4 mm	
	10 pole		96.4 mm	
Terminal Strips	11 pole		106.4 mm	
	12 pole		116.4 mm	

Installation Instructions

Wire Stripping Length	5 mm	6 mm
Mounting Hole Diameter	3.0 mm	3.6 mm
Terminal Screw Size	M2.6	M3

Terminal Strips

	Cat. No.	Length	Std. Pk.	Cat. No.	Length	Std. Pk.
2 pole	HE1WPR/02	13.2 mm	100	HE4WPR/02	16.4 mm	100
3 pole	HE1WPR/03	21.2 mm	100	HE4WPR/03	26.4 mm	100
4 pole	HE1WPR/04	29.2 mm	100	HE4WPR/04	36.4 mm	100
5 pole	HE1WPR/05	37.2 mm	100	HE4WPR/05	46.4 mm	100
6 pole	HE1WPR/06	45.2 mm	50	HE4WPR/06	56.4 mm	50
7 pole	HE1WPR/07	53.2 mm	50	HE4WPR/07	66.4 mm	50
8 pole	HE1WPR/08	61.2 mm	50	HE4WPR/08	76.4 mm	50
9 pole	HE1WPR/09	69.2 mm	50	HE4WPR/09	86.4 mm	50
10 pole	HE1WPR/10	77.2 mm	50	HE4WPR/10	96.4 mm	50
11 pole	HE1WPR/11	85.2 mm	50	HE4WPR/11	106.4 mm	50
12 pole	HE1WPR/12	93.2 mm	50	HE4WPR/12	116.4 mm	50

Accessories

	Cat. No.	Std. Pk.	Cat. No.	Std. Pk.
External Jumpers	2 pole HCL8-2	100	HCL10-2	100
	3 pole HCL8-3	100	HCL10-3	100
	4 pole HCL8-4	100	HCL10-4	100
	12 pole HCL8-12	25	HCL10-12	25
Marking Plates	Blank	-	BS24E	25
	No. 1-12	-	BS24EM1-12	25
	No. 13-24	-	BS24EM13-24	25

HE1 DIMENSIONS

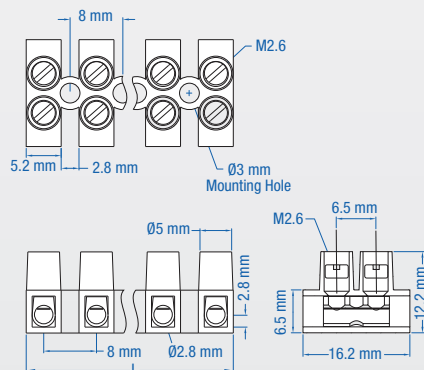

HE4 DIMENSIONS

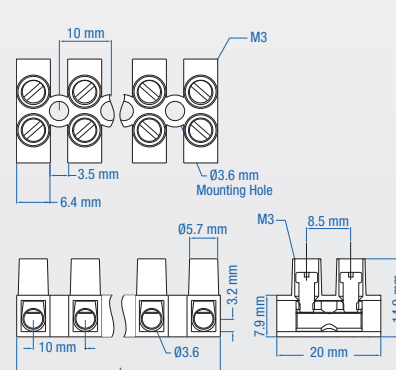

(All dimensions are shown in mm, to convert to inches please divide by 25.4)

FLAT BASE PANEL MOUNT 300 V - WIRE PROTECTOR



Dimensions & Weight

Pitch Spacing	12 mm	15 mm	15 mm
Weight per piece (12 pole)	47.0 g	95.5 g	94.5 g

Technical Data/Ratings

Approvals						
Wire Size (solid / stranded)	20-10 AWG	4-6 mm ²	18-8 AWG	6-10 mm ²	18-6 AWG	10-16 mm ²
Voltage Rating	300 V	400 V	300 V	400 V	300 V	400 V
Current Rating	40 A	16 A	50 A	25 A	63 A	35 A
Torque	7.0 lb-in	0.55 Nm	10.6 lb-in	0.84 Nm	17.7 lb-in	1.4 Nm
Insulation Material	Polyamide 66/6 V0		Polyamide 66/6 V0		Polyamide 66/6 V0	
Insert Material	Tinned Brass		Tinned Brass		Tinned Brass	
Terminal Screw Material	Blue Chromated Steel		Blue Chromated Steel		Blue Chromated Steel	

Installation Instructions

Wire Stripping Length	7 mm	8.5 mm	8.5 mm
Mounting Hole Diameter	4.2 mm	4.5 mm	4.5 mm
Terminal Screw Size	M3.5	M4	M5

Terminal Strips

	Cat. No.	Length	Std. Pk.	Cat. No.	Length	Std. Pk.	Cat. No.	Length	Std. Pk.
2 pole	HE6WPR/02	19.8 mm	100	HE10WPR/02	24.2 mm	50	HE16WPR/02	24.2 mm	50
3 pole	HE6WPR/03	31.8 mm	100	HE10WPR/03	39.2 mm	50	HE16WPR/03	39.2 mm	50
4 pole	HE6WPR/04	43.8 mm	100	HE10WPR/04	54.2 mm	50	HE16WPR/04	54.2 mm	50
5 pole	HE6WPR/05	55.8 mm	100	HE10WPR/05	69.2 mm	50	HE16WPR/05	69.2 mm	50
6 pole	HE6WPR/06	67.8 mm	50	HE10WPR/06	84.2 mm	25	HE16WPR/06	84.2 mm	25
7 pole	HE6WPR/07	79.8 mm	50	HE10WPR/07	99.2 mm	25	HE16WPR/07	99.2 mm	25
8 pole	HE6WPR/08	91.8 mm	50	HE10WPR/08	114.2 mm	25	HE16WPR/08	114.2 mm	25
9 pole	HE6WPR/09	103.8 mm	50	HE10WPR/09	129.2 mm	25	HE16WPR/09	129.2 mm	25
10 pole	HE6WPR/10	115.8 mm	25	HE10WPR/10	144.2 mm	10	HE16WPR/10	144.2 mm	10
11 pole	HE6WPR/11	127.8 mm	25	HE10WPR/11	159.2 mm	10	HE16WPR/11	159.2 mm	10
12 pole	HE6WPR/12	139.8 mm	25	HE10WPR/12	174.2 mm	10	HE16WPR/12	174.2 mm	10

Accessories

		Cat. No.	Std. Pk.	Cat. No.	Std. Pk.	Cat. No.	Std. Pk.
External Jumpers	2 pole	HCL12-2	100	HCL15-2	100	HCL15-2	100
	3 pole	HCL12-3	100	HCL15-3	100	HCL15-3	100
	4 pole	HCL12-4	100	HCL15-4	100	HCL15-4	100
	12 pole	HCL12-12	25	HCL15-12	25	HCL15-12	25
Marking Plates	Blank	BS60E	25	BS1016E	25	BS1016E	25
	No. 1-12	BS60EM1-12	25	BS1016EM1-12	25	BS1016EM1-12	25
	No. 13-24	BS60EM13-24	25	BS1016EM13-24	25	BS1016EM13-24	25

HE6 DIMENSIONS

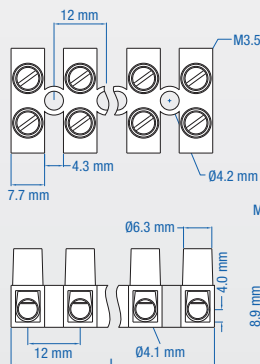

HE10 DIMENSIONS

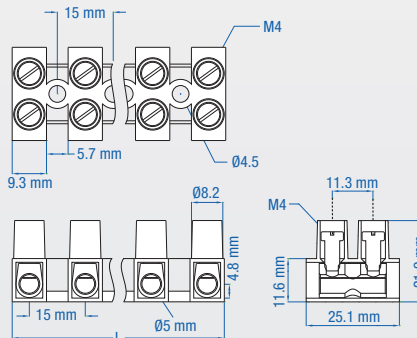

HE16 DIMENSIONS

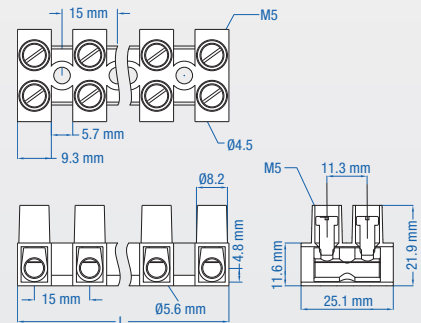

(All dimensions are shown in mm, to convert to inches please divide by 25.4)

HIGHLIGHTS

FEATURES

- 600V up to 63A
- Cost effective reliable wire-to-wire solution
- Easy to use double-row terminal strips
- Panel mount or free float
- Finger safe metal parts
- Wire protector
- easy to cut to required pole configuration
- Pre cut version in stock
- Color: white

APPLICATIONS

- HVAC
- Appliances
- Equipment
- Power Distribution
- Junction Boxes
- Cost effective alternative to barrier strips

HE1H



HE4HN



Dimensions & Weight

Pitch Spacing	8 mm	10 mm
Weight per piece (12 pole)	17.2 g	33.0 g

Technical Data/Ratings

Approvals	CE (F)	 E211022	 60998-2-1	 E211022	 60998-2-1
Wire Size (solid / stranded)		24-12 AWG	1-2.5 mm ²	24-10 AWG	2.5-4 mm ²
Voltage Rating		600 V	500 V	600 V	500 V
Current Rating		20 A	6 A	30 A	10 A
Torque		4.4 lb-in	0.35 Nm	7.0 lb-in	0.4 Nm
Insulation Material		Polyamide 66/6 V0		Polyamide 66/6 V0	
Insert Material		Tinned Brass		Tinned Brass	
Screw Material		Blue Chromated Steel		Blue Chromated Steel	

Installation Instructions

Wire Stripping Length	5 mm	6 mm
Mounting Hole Diameter	3.0 mm	3.6 mm
Terminal Screw Size	M2.6	M3

Terminal Strips

	Cat. No.	Length	Std. Pk.	Cat. No.	Length	Std. Pk.
2 pole	HE1HWPR/02	13.2 mm	100	HE4HNWPR/02	16.4 mm	100
3 pole	HE1HWPR/03	21.2 mm	100	HE4HNWPR/03	26.4 mm	100
4 pole	HE1HWPR/04	29.2 mm	100	HE4HNWPR/04	36.4 mm	100
5 pole	HE1HWPR/05	37.2 mm	100	HE4HNWPR/05	46.4 mm	100
6 pole	HE1HWPR/06	45.2 mm	50	HE4HNWPR/06	56.4 mm	50
7 pole	HE1HWPR/07	53.2 mm	50	HE4HNWPR/07	66.4 mm	50
8 pole	HE1HWPR/08	61.2 mm	50	HE4HNWPR/08	76.4 mm	50
9 pole	HE1HWPR/09	69.2 mm	50	HE4HNWPR/09	86.4 mm	50
10 pole	HE1HWPR/10	77.2 mm	50	HE4HNWPR/10	96.4 mm	50
11 pole	HE1HWPR/11	85.2 mm	50	HE4HNWPR/11	106.4 mm	50
12 pole	HE1HWPR/12	93.2 mm	50	HE4HNWPR/12	116.4 mm	50

Accessories

	Cat. No.	Std. Pk.	Cat. No.	Std. Pk.
External Jumpers	2 pole HCL8-2	100	HCL10-2	100
	3 pole HCL8-3	100	HCL10-3	100
	4 pole HCL8-4	100	HCL10-4	100
	12 pole HCL8-12	25	HCL10-12	25
	Marking Plates	Blank	-	BS24E
No. 1-12		-	BS24EM1-12	25
No. 13-24		-	BS24EM13-24	25
Isolation Partition	-	-	HEP4/6H	5
Mounting Pins	-	-	H4	50

HE1H DIMENSIONS

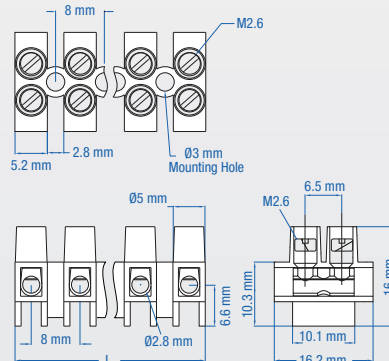

HE4HN DIMENSIONS

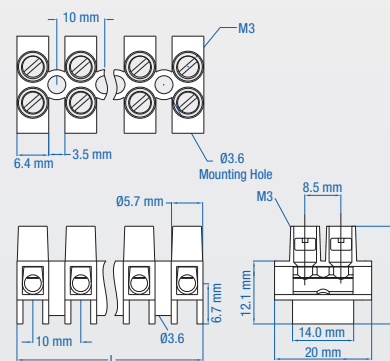

(All dimensions are shown in mm, to convert to inches please divide by 25.4)

HE6H



HE10H



HE16H



Dimensions & Weight

Pitch Spacing	12 mm	15 mm	15 mm
Weight per piece (12 pole)	49.1 g	98.7 g	99.3 g

Technical Data/Ratings

Approvals						
	Wire Size (solid / stranded)	20-10 AWG	4-6 mm ²	18-8 AWG	6-10 mm ²	18-6 AWG
Voltage Rating	600 V	500 V	600 V	500 V	600 V	500 V
Current Rating	40 A	16 A	50 A	25 A	63 A	35 A
Torque	7.0 lb-in	0.55 Nm	7.6 lb-in	0.84 Nm	17.7 lb-in	1.4 Nm
Insulation Material	Polyamide 66/6 V0		Polyamide 66/6 V0		Polyamide 66/6 V0	
Insert Material	Tinned Brass		Tinned Brass		Tinned Brass	
Terminal Screw Material	Blue Chromated Steel		Blue Chromated Steel		Blue Chromated Steel	

Installation Instructions

Wire Stripping Length	5 mm	6 mm	6 mm
Mounting Hole Diameter	4.2 mm	4.5 mm	4.5 mm
Terminal Screw Size	M3.5	M4	M5

Terminal Strips

	Cat. No.	Length	Std. Pk.	Cat. No.	Length	Std. Pk.	Cat. No.	Length	Std. Pk.
2 pole	HE6HWPR/02	19.8 mm	100	HE10HWPR/02	24.2 mm	40	HE16HWPR/02	24.2 mm	40
3 pole	HE6HWPR/03	31.8 mm	100	HE10HWPR/03	39.2 mm	40	HE16HWPR/03	39.2 mm	40
4 pole	HE6HWPR/04	43.8 mm	100	HE10HWPR/04	54.2 mm	40	HE16HWPR/04	54.2 mm	40
5 pole	HE6HWPR/05	55.8 mm	100	HE10HWPR/05	69.2 mm	40	HE16HWPR/05	69.2 mm	40
6 pole	HE6HWPR/06	67.8 mm	50	HE10HWPR/06	84.2 mm	20	HE16HWPR/06	84.2 mm	20
7 pole	HE6HWPR/07	79.8 mm	50	HE10HWPR/07	99.2 mm	20	HE16HWPR/07	99.2 mm	20
8 pole	HE6HWPR/08	91.8 mm	50	HE10HWPR/08	114.2 mm	20	HE16HWPR/08	114.2 mm	20
9 pole	HE6HWPR/09	103.8 mm	50	HE10HWPR/09	129.2 mm	10	HE16HWPR/09	129.2 mm	10
10 pole	HE6HWPR/10	115.8 mm	25	HE10HWPR/10	144.2 mm	10	HE16HWPR/10	144.2 mm	10
11 pole	HE6HWPR/11	127.8 mm	25	HE10HWPR/11	159.2 mm	10	HE16HWPR/11	159.2 mm	10
12 pole	HE6HWPR/12	139.8 mm	25	HE10HWPR/12	174.2 mm	10	HE16HWPR/12	174.2 mm	10

Accessories

	Cat. No.	Std. Pk.	Cat. No.	Std. Pk.	Cat. No.	Std. Pk.	
External Jumpers	2 pole	HCL12-2	100	HCL15-2	100	HCL15-2	100
	3 pole	HCL12-3	100	HCL15-3	100	HCL15-3	100
	4 pole	HCL12-4	100	HCL15-4	100	HCL15-4	100
	12 pole	HCL12-12	25	HCL15-12	25	HCL15-12	25
	Marking Plates	Blank	BS60E	25	-	-	-
No. 1-12		BS60EM1-12	25	-	-	-	
No. 13-24		BS60EM13-24	25	-	-	-	
Isolation Partition	HEP4/6H	5	-	-	-		
Mounting Pins	H6	50	-	-	-		

HE6H DIMENSIONS

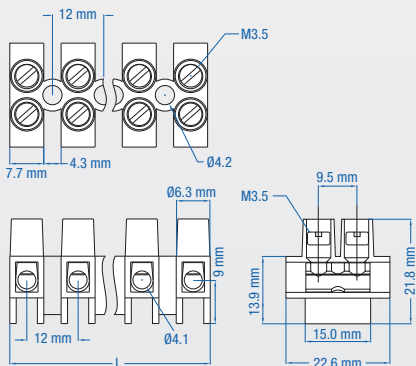

HE10H DIMENSIONS

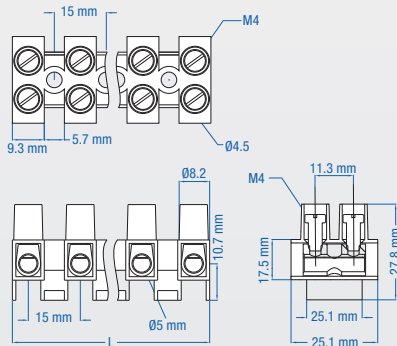

HE16H DIMENSIONS

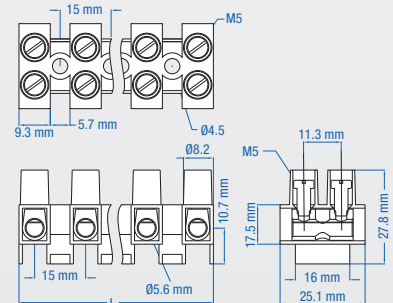

(All dimensions are shown in mm, to convert to inches please divide by 25.4)

HE42SST

HE42SBU



Dimensions & Weight

Pitch Spacing	10 mm	10 mm
Weight per piece (12 pole)	30.6 g	30.4 g

Technical Data/Ratings

Approvals				
	24-10 AWG	2.5-4 mm ²	24-10 AWG	2.5-4 mm ²
Wire Size (solid / stranded)	24-10 AWG	2.5-4 mm ²	24-10 AWG	2.5-4 mm ²
Voltage Rating	600 V	500 V	600 V	500 V
Current Rating	20 A	10 A	20 A	10 A
Torque	7.0 lb-in	0.4 Nm	7.0 lb-in	0.4 Nm
Insulation Material	Polyamide 66/6 V0		Polyamide 66/6 V0	
Insert Material	Tinned Brass		Tinned Brass	
Terminal Screw Material	Blue Chromated Steel		Blue Chromated Steel	

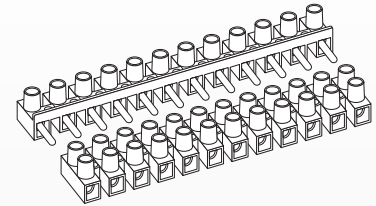

Installation Instructions

Wire Stripping Length	7 mm	6 mm
Mounting Hole Diameter	3.0 mm	3.6 mm
Terminal Screw Size	M3.5	M4

Terminal Strips

	Cat. No.	Length	Std. Pk.	Cat. No.	Length	Std. Pk.
2 pole	HE42SST/02	16.4 mm	100	HE42SBU/02	16.4 mm	100
3 pole	HE42SST/03	26.4 mm	100	HE42SBU/03	26.4 mm	100
4 pole	HE42SST/04	36.4 mm	100	HE42SBU/04	36.4 mm	100
5 pole	HE42SST/05	46.4 mm	100	HE42SBU/05	46.4 mm	100
6 pole	HE42SST/06	56.4 mm	50	HE42SBU/06	56.4 mm	50
7 pole	HE42SST/07	66.4 mm	50	HE42SBU/07	66.4 mm	50
8 pole	HE42SST/08	76.4 mm	50	HE42SBU/08	76.4 mm	50
9 pole	HE42SST/09	86.4 mm	50	HE42SBU/09	86.4 mm	50
10 pole	HE42SST/10	96.4 mm	50	HE42SBU/10	96.4 mm	50
11 pole	HE42SST/11	106.4 mm	50	HE42SBU/11	106.4 mm	50
12 pole	HE42SST/12	116.4 mm	50	HE42SBU/12	116.4 mm	50

Accessories

	Cat. No.	Std. Pk.	Cat. No.	Std. Pk.
External Jumpers	2 pole HCL10-2	100	HCL10-2	100
	3 pole HCL10-3	100	HCL10-3	100
	4 pole HCL10-4	100	HCL10-4	100
	12 pole HCL10-12	25	HCL10-12	25
Marking Plates	Blank BS24E	25	BS24E	25
	No. 1-12 BS24EM1-12	25	BS24EM1-12	25
	No. 13-24 BS24EM13-24	25	BS24EM13-24	25

HE42SST DIMENSIONS

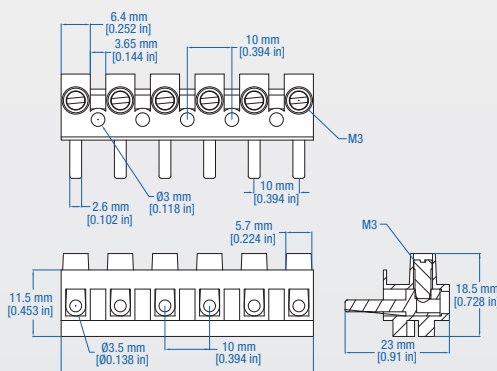

HE42SBU DIMENSIONS

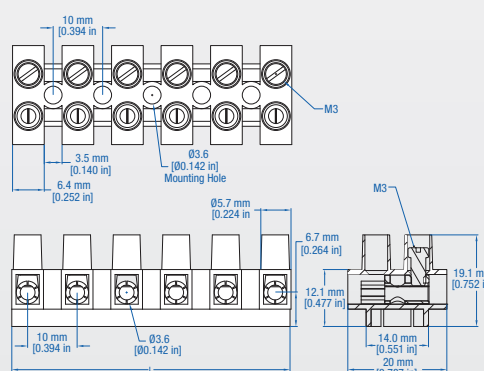

(All dimensions are shown in mm, to convert to inches please divide by 25.4)

HIGHLIGHTS

FEATURES

- Center Barrier / Wire Protector
- 300V/600V up to 63A
- Cost effective reliable wire-to-wire solution
- Easy to use double-row terminal strips
- Panel mount or free float
- Finger safe metal parts
- Wire protector
- easy to cut to required pole configuration
- Pre cut version in stock
- Color: translucent white

APPLICATIONS

- HVAC
- Appliances
- Equipment
- Power Distribution
- Junction Boxes
- Cost effective alternative to barrier strips

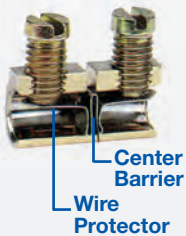

Dimensions & Weight

Pitch Spacing	8 mm	10 mm	12 mm
Weight per piece (12 pole)	22 g	34 g	44 g

Technical Data/Ratings

Approvals	CE	FI	EH						
Wire Size (solid / stranded)	22-12 AWG	22-16 AWG	0.2-1.5 mm ²	22-10 AWG	18-12 AWG	0.2-4 mm ²	20-8 AWG	18-10 AWG	0.2-6 mm ²
Voltage Rating	300 V	300 V	400 V	300 V	300 V	400 V	300 V	300 V	400 V
Current Rating	20 A	15 A	15 A	30 A	30 A	26 A	40 A	40 A	44 A
Torque	4.4 lb-in / 0.5 Nm			5.3 lb-in / 0.5 Nm			7 lb-in / 0.5 Nm		
Insulation Material	Polyamide 6.6			Polyamide 6.6			Polyamide 6.6		
Insert Material	Nickel Plated Copper Alloy			Nickel Plated Copper Alloy			Nickel Plated Copper Alloy		
Terminal Screw Material	Zinc Yellow Chromated Steel			Zinc Yellow Chromated Steel			Zinc Yellow Chromated Steel		

Installation Instructions

Wire Stripping Length	5 mm (0.2 in.)	6 mm (0.24 in.)	7 mm (0.28 in.)
Mounting Hole Diameter	2.8 mm	3.5 mm	4.4 mm
Terminal Screw Size	M2.5	M3	M3.5

Terminal Blocks

	Cat. No.	Type	L (mm)	Pk.	Cat. No.	Type	L (mm)	Pk.	Cat. No.	Type	L (mm)	Pk.
2 pole	40.002	ATS1.5/2	13.6 mm	100	40.202	ATS1.5/2	17.0 mm	100	40.402	ATS1.5/2	20.0 mm	100
3 pole	40.003	ATS1.5/3	21.5 mm	100	40.203	ATS1.5/3	27.0 mm	100	40.403	ATS1.5/3	32.0 mm	100
4 pole	40.004	ATS1.5/4	29.5 mm	100	40.204	ATS1.5/4	37.0 mm	100	40.404	ATS1.5/4	44.0 mm	100
5 pole	40.005	ATS1.5/5	37.4 mm	100	40.205	ATS1.5/5	47.0 mm	100	40.405	ATS1.5/5	56.0 mm	100
6 pole	40.006	ATS1.5/6	45.4 mm	50	40.206	ATS1.5/6	57.0 mm	50	40.406	ATS1.5/6	68.0 mm	50
7 pole	40.007	ATS1.5/7	53.3 mm	50	40.207	ATS1.5/7	67.0 mm	50	40.407	ATS1.5/7	80.0 mm	50
8 pole	40.008	ATS1.5/8	61.3 mm	50	40.208	ATS1.5/8	77.0 mm	50	40.408	ATS1.5/8	92.0 mm	50
9 pole	40.009	ATS1.5/9	69.2 mm	50	40.209	ATS1.5/9	87.0 mm	50	40.409	ATS1.5/9	104.0 mm	50
10 pole	40.010	ATS1.5/10	77.2 mm	50	40.210	ATS1.5/10	97.0 mm	50	40.410	ATS1.5/10	116.0 mm	50
11 pole	40.011	ATS1.5/11	85.1 mm	50	40.211	ATS1.5/11	107.0 mm	50	40.411	ATS1.5/11	128.0 mm	50
12 pole	40.012	ATS1.5/12	93.0 mm	50	40.212	ATS1.5/12	117.0 mm	50	40.412	ATS1.5/12	140.0 mm	50

Accessories

	Cat. No.	Std. Pk.	Cat. No.	Std. Pk.	Cat. No.	Std. Pk.
External Jumpers	HCL8-2	100	HCL10-2	100	HCL12-2	100
	HCL8-3	100	HCL10-3	100	HCL12-3	100
	HCL8-4	100	HCL10-4	100	HCL12-4	100
	HCL8-12	25	HCL10-12	25	HCL12-12	25
Marking Plates	-	-	BS24E	25	BS60E	25
	-	-	BS24EM1-12	25	BS60EM1-12	25
	-	-	BS24EM13-24	25	BS60EM13-24	25

ATS1.5 DIMENSIONS

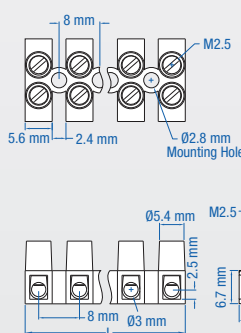

ATS2.5 DIMENSIONS

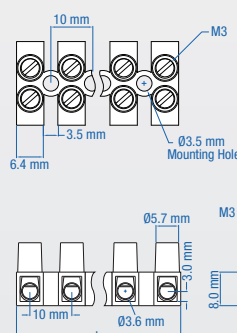

ATS6 DIMENSIONS

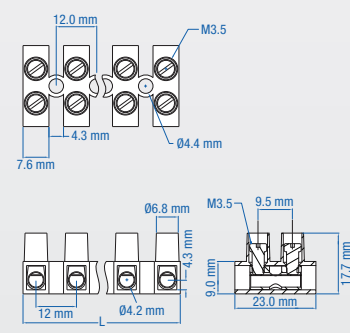

(All dimensions are shown in mm, to convert to inches please divide by 25.4)

ATSF1.5



ATSF2.5



ATSF6



ATSF16

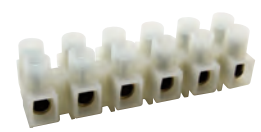

Dimensions & Weight

Pitch Spacing	8 mm	10 mm	12 mm	15 mm
Weight per piece (12 pole)	30 g	36 g	50 g	98 g

Technical Data/Ratings

Approvals												
Wire Size (solid / stranded)	22-12 AWG	22-16 AWG	0.2-1.5 mm ²	22-10 AWG	18-12 AWG	0.2-4 mm ²	20-8 AWG	18-10 AWG	0.2-6 mm ²	14-6 AWG	18-6 AWG	0.2-16 mm ²
Voltage Rating	600 V	600 V	400 V	600 V	600 V	400 V	600 V	600 V	400 V	600 V	600 V	800 V
Current Rating	20 A	15 A	15 A	30 A	30 A	26 A	40 A	40 A	44 A	63 A	65 A	82 A
Torque	4.4 lb-in / 0.5 Nm			5.3 lb-in / 0.6 Nm			7 lb-in / 0.8 Nm			20 lb-in / 2.25 Nm		
Insulation Material	Polyamide 6.6			Polyamide 6.6			Polyamide 6.6			Polyamide 6.6		
Insert Material	Nickel Plated Copper Alloy			Nickel Plated Copper Alloy			Nickel Plated Copper Alloy			Nickel Plated Copper Alloy		
Terminal Screw Material	Zinc Yellow Chromated Steel			Zinc Yellow Chromated Steel			Zinc Yellow Chromated Steel			Zinc Yellow Chromated Steel		

Installation Instructions

Wire Stripping Length	5 mm (0.2 in.)	6 mm (0.24 in.)	7 mm (0.28 in.)	8 mm (0.32 in.)
Mounting Hole Diameter	2.8 mm	3.5 mm	4.4 mm	4.2 mm
Terminal Screw Size	M2.5	M3	M3.5	M5

Terminal Blocks

	Cat. No.	Type	L (mm)	Pk.	Cat. No.	Type	L (mm)	Pk.	Cat. No.	Type	L (mm)	Pk.	Cat. No.	Type	L (mm)	Pk.
2 pole	40.102	ATSF1.5/2	13.6	100	40.302	ATSF2.5/2	17.0	100	40.502	ATSF6/2	20.0	100	40.702	ATSF16/2	25.0	40
3 pole	40.103	ATSF1.5/3	21.5	100	40.303	ATSF2.5/3	27.0	100	40.503	ATSF6/3	32.0	100	40.703	ATSF16/3	40.0	40
4 pole	40.104	ATSF1.5/4	29.5	100	40.304	ATSF2.5/4	37.0	100	40.504	ATSF6/4	44.0	100	40.704	ATSF16/4	55.0	40
5 pole	40.105	ATSF1.5/5	37.4	100	40.305	ATSF2.5/5	47.0	100	40.505	ATSF6/5	56.0	100	40.705	ATSF16/5	70.5	40
6 pole	40.106	ATSF1.5/6	45.4	50	40.306	ATSF2.5/6	57.0	50	40.506	ATSF6/6	68.0	50	40.706	ATSF16/6	86.0	20
7 pole	40.107	ATSF1.5/7	53.3	50	40.307	ATSF2.5/7	67.0	50	40.507	ATSF6/7	80.0	50	40.707	ATSF16/7	101.0	20
8 pole	40.108	ATSF1.5/8	61.3	50	40.308	ATSF2.5/8	77.0	50	40.508	ATSF6/8	92.0	50	40.708	ATSF16/8	116.0	20
9 pole	40.109	ATSF1.5/9	69.2	50	40.309	ATSF2.5/9	87.0	50	40.509	ATSF6/9	104.0	50	40.709	ATSF16/9	131.0	10
10 pole	40.110	ATSF1.5/10	77.2	50	40.310	ATSF2.5/10	97.0	50	40.510	ATSF6/10	116.0	25	40.710	ATSF16/10	146.0	10
11 pole	40.111	ATSF1.5/11	85.1	50	40.311	ATSF2.5/11	197.0	50	40.511	ATSF6/11	128.0	25	40.711	ATSF16/11	161.0	10
12 pole	40.112	ATSF1.5/12	93.0	50	40.312	ATSF2.5/12	117.0	50	40.512	ATSF6/12	140.0	25	40.712	ATSF16/12	176.0	10

Accessories

	Cat. No.	Std. Pk.	Cat. No.	Std. Pk.	Cat. No.	Std. Pk.	Cat. No.	Std. Pk.
External Jumpers	HCL8-2	100	HCL10-2	100	HCL12-2	100	HCL15-2	100
	HCL8-3	100	HCL10-3	100	HCL12-3	100	HCL15-3	100
	HCL8-4	100	HCL10-4	100	HCL12-4	100	HCL15-4	100
	HCL8-12	25	HCL10-12	25	HCL12-12	25	HCL15-12	25
Isolation Partition	-	-	HEP4/6H	5	HEP4/6H	5	-	-
Mounting Pins	-	-	H4	50	H6	50	-	-
Marking Plates	-	-	BS24E	25	BS60E	25	BS1016E	25
	-	-	BS24EM1-12	25	BS60EM1-12	25	BS1016EM1-12	25
	-	-	BS24EM13-24	25	BS60EM13-24	25	BS1016EM13-24	25

ATSF1.5 DIMENSIONS

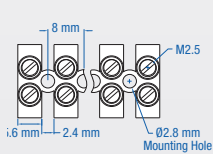

ATSF2.5 DIMENSIONS

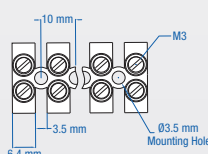

ATSF6 DIMENSIONS

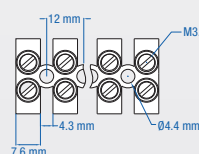

ATSF16 DIMENSIONS

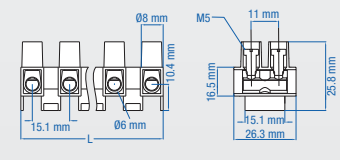
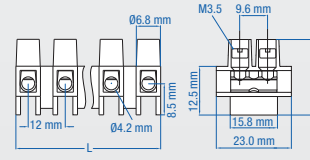
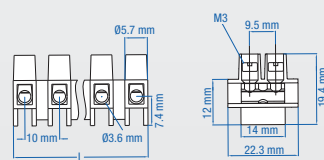
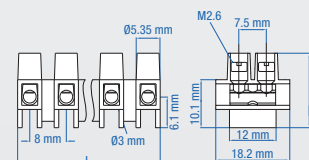
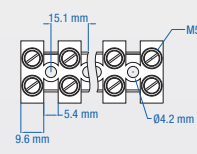

(All dimensions are shown in mm, to convert to inches please divide by 25.4)

HIGHLIGHTS

EXTERNAL JUMPERS

- Bus potential between poles on terminal Strips
- Eliminates Wire Jumpers
- Less wiring Time
- Material: Copper Alloy nickel plated (pins)
Polyamide 66 (Insulation)
- Color: Black

ISOLATION PARTITION

- Separation between adjacent poles of different potentials
- Visual separation of poles
- Better circuit Identification
- Increasing wiring efficiency
- Material: Polyamide 66
- Color: black

EXTERNAL JUMPERS



Technical Information

External Jumper	HCL8	HCL10	HCL12	HCL15
Eurostrip	HE1, HE1H	HE4, HE4HN	HE6, HE6H	HE10, HE16, HE10H, HE16H
Pole Spacing	8 mm (0.315 in.)	10 mm (0.394 in.)	12 mm (0.472 in.)	15 mm (0.591 in.)

Ordering Information

	Cat. No.	Length	Std. Pk.	Cat. No.	Length	Std. Pk.	Cat. No.	Length	Std. Pk.	Cat. No.	Length	Std. Pk.
2 pole	HCL8-2	12 mm	100	HCL10-2	15 mm	100	HCL12-2	18 mm	100	HCL15-2	20 mm	100
3 pole	HCL8-3	20 mm	100	HCL10-3	25 mm	100	HCL12-3	30 mm	100	HCL15-3	35 mm	100
4 pole	HCL8-4	28 mm	100	HCL10-4	35 mm	100	HCL12-4	42 mm	100	HCL15-4	50 mm	100
12 pole	HCL8-12	92 mm	25	HCL10-12	115 mm	25	HCL12-12	138 mm	25	HCL15-12	170 mm	25

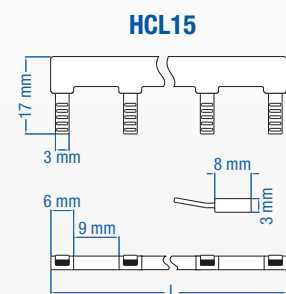
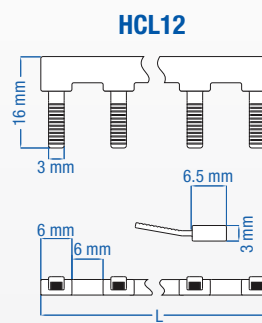
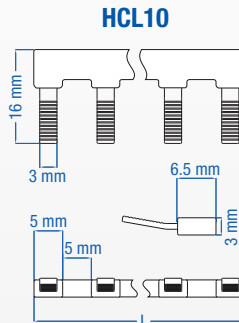
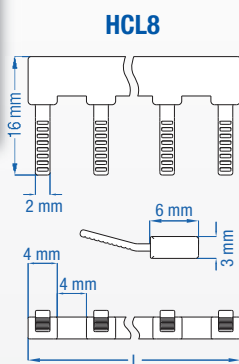

ISOLATION PARTITIONS

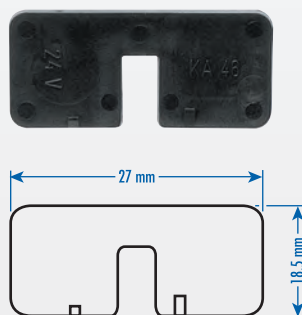

For Eurostrip HE4HN, HE6H, TSF2.5, TSF6

Cat. No.	Dimensions	Std. Pk.
HEP4/16H	27 x 18.5 x 3.4 mm	5

(All dimensions are shown in mm, to convert to inches please divide by 25.4)

ACCESSORIES

MOUNTING PINS



Technical Information

Mounting Pins	H4	H6
Eurostrip Type	HE4HN	HE6H
Panel Thickness	0.5-1.5 mm	0.8-1.8 mm
Drill Hole Size	Ø4.2 mm	Ø5.2mm

Ordering Information

Cat. No.	Std. Pk.	Cat. No.	Std. Pk.
H4	50	H6	50

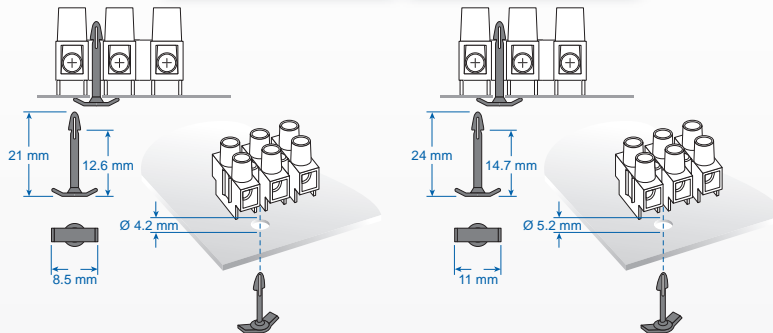

MARKING PLATES



Dimensions & Weight

Eurostrip Type	HE4, HE4HN	HE6, HE6H	HE10, HE10H, HE16, HE16H
----------------	------------	-----------	--------------------------

Ordering Information

	Cat. No.	Std. Pk.	Cat. No.	Std. Pk.	Cat. No.	Std. Pk.
Blank	BS24E	25	BS60E	25	BS1016E	25
1-12	BS24EM1-12	25	BS60EM1-12	25	BS1016EM1-12	25
13-24	BS24EM13-24	25	BS60EM13-24	25	BS1016EM13-24	25

IMPRINTING

Imprint Example



HE10HWPR/06/1-6

Order Examples

Ordering Information

	Cat. No.	Std. Pk.
Consecutive 1-6	HE10HWPR/06/1-6	500
Consecutive 8-1	HE1WPR/08/8-1	500
Identical	HE6WPR/12/1	500

For custom imprints please contact Altech.

HIGHLIGHTS

MOUNTING PINS

- Faster Panel Mounting with snap-on mounting pins
- Installation
 - 1) Insert Pin through drilled hole
 - 2) Position Eurostrip on mounting pin
 - 3) Snap Eurostrip onto Mounting Pins
- Use 2 or more pins per Eurostrip
- Material: Polycarbonate

MARKING PLATES

- Install Mounting Plate under or on top of Eurostrip
- Easy identification of individual pole positions for more wiring efficiency
- Less installation time
- Blank marking plates for hand-marking
- Imprinted Marking Plates (No. 1-12, 13-24)
- Material: PVC
- Color: white with black imprint

Imprinting

- Mark individual pole positions
- Marking saves installation Time
- Marking on turret location
- Consecutive, identical or custom imprints
- Specify imprinting in part#
- Imprint: black ink, rub-resistant
- 500pcs MOQ

(All dimensions are shown in mm, to convert to inches please divide by 25.4)

HIGHLIGHTS

FEATURES

- Altech DIN Rails comply with DIN EN60715, EN50022, EN50035, EN50045 standards
- Easy mounting of terminal blocks, power supplies and other control components and devices into panel
- Space saving
- Reduces labor
- 35mm, 32mm and 15mm versions
- 1m and 2m standard length
- Custom length available
- Perforated, unperforated

MATERIAL

- Zinc-plated steel
 - 35x7.5mm
 - 35x15mm
 - 32mm
 - 15mm
- Aluminum
 - 35x7.5mm
- Stainless Steel (Type AISI 304)
 - 35x7.5mm

DIN35 x 7.5

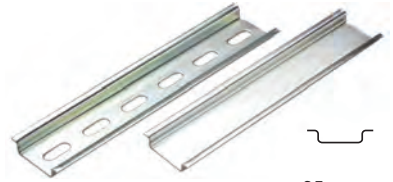

35 mm x
7.5 mm deep

Zinc Plated Steel

Type	Cat. No.	Length	Std. Pk.
Perforated	2511120	2m	20
	2511120/1M	1m	20
Unperforated	2511110	2m	20
	2511110/1M	1m	20

Stainless Steel

Type	Cat. No.	Length	Std. Pk.
Perforated	2511125	2m	20
	2511125/1M	1m	20
Unperforated	2511115	2m	20
	2511115/1M	1m	20

Aluminum

Type	Cat. No.	Length	Std. Pk.
Perforated	2511121	2m	20
	2511121/1M	1m	20
Unperforated	2511111	2m	20
	2511111/1M	1m	20

DIN35 x 15

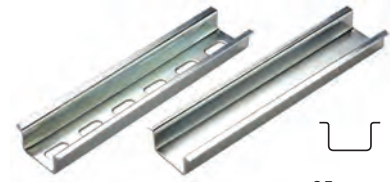

35 mm x
15 mm deep

Zinc Plated Steel

Type	Cat. No.	Length	Std. Pk.
Perforated	CA701-15/S-2M	2m	10
	CA701-15/S	1m	10
Unperforated	CA701-15-2M	2m	10
	CA701-15	1m	10

Dimensions

Perforated Steel and Stainless

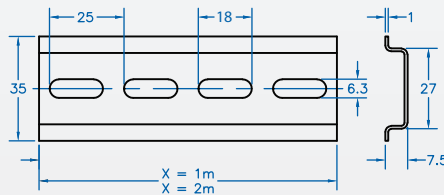

Perforated Steel

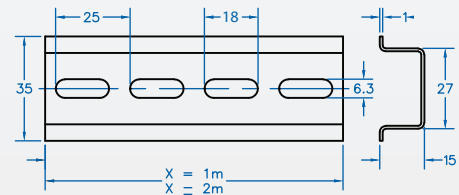

Perforated Aluminum

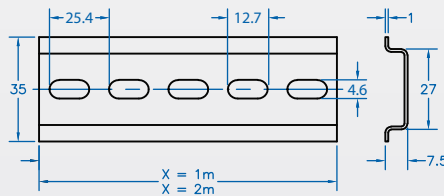

Unperforated Steel

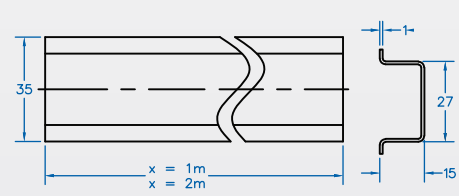

Unperforated

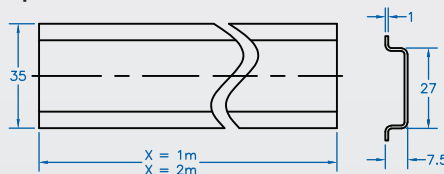

DIN32



32 mm x
15 mm deep

Zinc Plated Steel

Type	Cat. No.	Length	Std. Pk.
Perforated	2511160	2m	10
	2511160/1M	1m	20
Unperforated	2511150	2m	10
	2511150/1M	1m	20

DIN15



15 mm x
5.5 mm deep

Zinc Plated Steel

Type	Cat. No.	Length	Std. Pk.
Perforated	CA601/S	1m	50

Dimensions

Perforated Steel

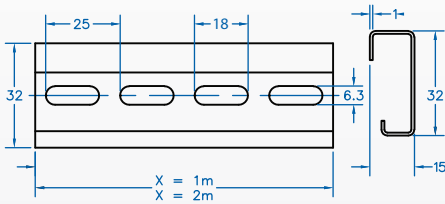

Perforated Steel

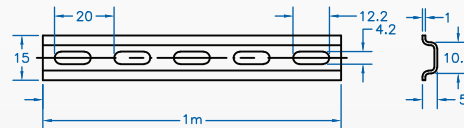

Unperforated Steel

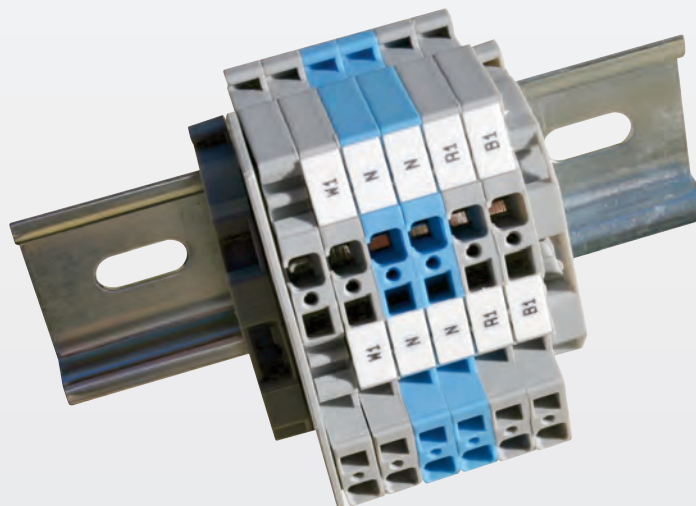
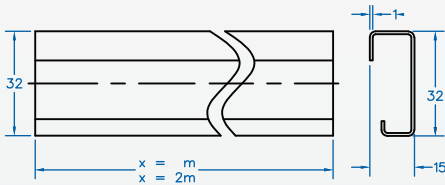

HIGHLIGHTS

SUPPORT BRACKETS

- Elevate DIN Rail away from panel
- Easier mounting of components
- Suitable for all mounting rails
- Increase wiring access
- 45° version for improved visibility
- Straight brackets available in 3 heights:
 - 1"
 - 2"
 - 3"

MOUNTING

- Brackets mount with 2 screws to any panel or flat surface
- Tapped center hole for DIN Rail mounting

MATERIAL

- Zinc-plated yellow chromated Steel

UNIVERSAL DIN CLIPS

- Clips on to any 35mm/32mm DIN Rail
- Flexible mounting solution
- Mount any component on 32mm/35mm DIN Rail
- Various mounting hole solutions
- Material: zinc-plated steel, Polyamide 66

SPACER

- Increases creepage and clearance distance between terminal blocks
- Segregate different groups of terminal blocks

WARNING LABELS

- Mounted on top of terminal block for visual identification
- Make entire terminal block assembly shock-proof

SUPPORT BRACKETS



Cat. No.	Std. Pk.
CA603	25

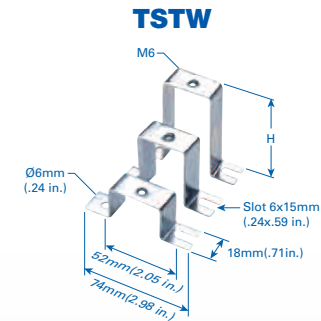

Cat. No.	Height	Std. Pk.
CA703	1 in.	25
CA803	2 in.	25
CA903	3 in.	25

UNIVERSAL DIN CLIPS

D35CLIP

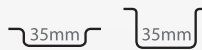

Cat. No.	Mounting Hole	Std. Pk.
D35CLIP-M4	M4	100
D35CLIP-M5	M5	100

CMTB35

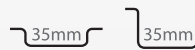
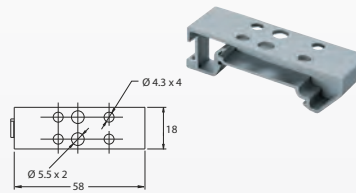

Cat. No.	Mounting Hole	Std. Pk.
CMTB35	2x4.4 mm	50
	2x5.5 mm	

CA902

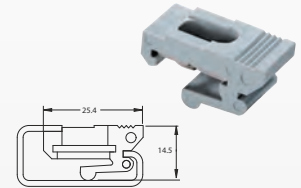

Cat. No.	Std. Pk.
CA902	100

SPACER

CASP



Cat. No.	Dimensions	Std. Pk.
CASP	29 x 43 x 8 mm	50

CDL4U SPACER



Cat. No.	Dimensions	Std. Pk.
CDL4USP	54 x 55.5 x 6 mm	50

WARNING LABELS

Cat. No.	Terminal Blocks	Pack	Std. Pk. Strips	Tags
WLX2.5	CX2.5 Series, CXDL2.5, CXK2.5, CXM2.5	1	20	100
WLX4	CX4 Series, CXF Series, CXK4	1	20	100
WLX6	CX6 Series, CXDB Series	1	20	100
WLX10	CX10 Series	1	20	100
SWL4	CTS4U-N, CDB4, CMDB4	1	20	100
SWL10	CTS6U, CDB6U, CMDB6	1	20	100



END STOPS

Selection Table

DIN Rail Type	CA102	CA202	CA702	CA802	CA103	CA602	CA302	CA402	CA502
35x7.5mm DIN Rail	✓	✓	✓	✓	✓		✓		
35x15mm DIN Rail	✓	✓	✓	✓	✓			✓	
32mm DIN Rail	✓		✓						✓
15mm DIN Rail						✓			

HIGHLIGHTS

MOUNTING PINS

- End Stops prevent Terminal Blocks and other DIN Rail components from moving on the rail
- Versions for
 - 35x7.5mm Rail
 - 35x15mm Rail
 - 32mm Rail
 - 15mm Rail
- Heavy Duty End stop **CA102, CA202**
- Screwless End Stop **CA103** (snap on)
- Material:
 - Polyamide
 - Steel

POLYAMIDE 66

CA702



Cat. No.	Dimensions	Std. Pk.
CA702	34 x 44 x 9mm	50

CA802



Cat. No.	Dimensions	Std. Pk.
CA802	32 x 45 x 8mm	50

CA202



Heavy Duty End Stop



Cat. No.	Dimensions	Std. Pk.
CA202	44.5 x 50 x 9.5mm	50

CA102



Cat. No.	Dimensions	Std. Pk.
CA102	46 x 50 x 9mm	50

CA103

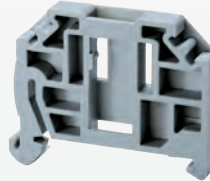

Screwless Snap-On

Cat. No.	Dimensions	Std. Pk.
CA103	41 x 35 x 6mm	50

CA602



Cat. No.	Dimensions	Std. Pk.
CA602	20 x 28 x 8mm	50

STEEL

CA302



Cat. No.	Dimensions	Std. Pk.
CA302	27 x 39.5 x 16mm	50

CA402



Cat. No.	Dimensions	Std. Pk.
CA402	27 x 39.5 x 16mm	50

CA502



Cat. No.	Dimensions	Std. Pk.
CA502	25 x 22.5 x 11.5mm	50

HIGHLIGHTS

FEATURES

- Group identification
- Holders fit standard **MT8** marking tags
- GMH6, GMH7 mounted directly on DIN Rail
- GMH1, GMH2, GMH3, GMH4, GMH5, GMH8 mounted on End Stops
- MT1G, MT2G, can be used with all these holders or can be directly mounted on all end stops
- Material: Polyamide 66

DIN RAIL MOUNT

GMH6



Cat. No.	Dimensions	Std. Pk.
GMH6	46.5 x 44.5 x 9.5mm	50

GMH7

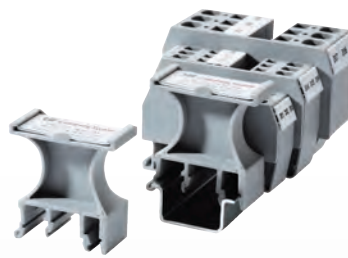

Cat. No.	Dimensions	Std. Pk.
GMH7	46.5 x 44.5 x 19.5mm	50

MOUNT ON END STOP

GMH1

Suitable for CA602

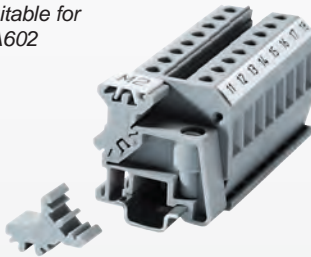

Cat. No.	Dimensions	Std. Pk.
GMH1	15.8 x 14.6 x 8mm	100

GMH4

Suitable for CA802



Cat. No.	Dimensions	Std. Pk.
GMH4	16.2 x 14 x 8mm	100

GMH5

Suitable for CA702



Cat. No.	Dimensions	Std. Pk.
GMH5	13.7 x 14 x 8mm	100

GMH2 / GMH3

Suitable for CA702 (GMH2)
CA802 (GMH3)

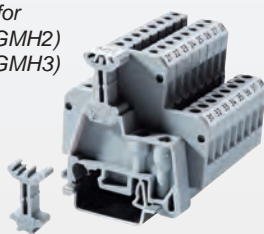

Cat. No.	Dimensions	Std. Pk.
GMH2	23.2 x 14 x 8mm	100
GMH3	23 x 14 x 8mm	100

GMH8 / GMH8N

Suitable for CA103



Cat. No.	Dimensions	Std. Pk.
GMH8	44.65 x 31.10 x 10mm	100
GMH8N	44.65 x 31.10 x 6mm	100

MTG1 / MTG2

Mountable on all End Clamps

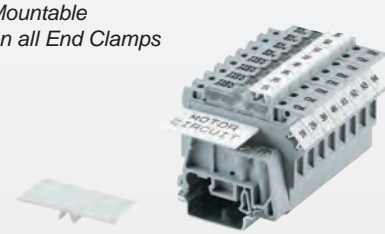

Cat. No.	Dimensions	Std. Pk.
MTG1	4.3 x 34 x 17.8mm	50
MTG2	4.3 x 34 x 8mm	50

TM5

Suitable for CXDL Series



Cat. No.	Dimensions	Std. Pk.
TM5	38 x 17 x 5mm	50

MARKING TAGS



- Cost Effective MT marking system for quick and accurate identification
- Push-On Tags fit all Altech DIN Rail mount terminal blocks
- Inserted individually or as strips of 10
- Quick and easy marking
- Blank Marking Tags for customer marking
- Order with horizontal/ vertical imprint
- Standard imprints with consecutive or identical numbers/ characters
- Custom imprint with short lead time
- Supplied in packs of 100 tags/ 10 strips

BLANK MARKING TAGS

Cat No./ Type	Standard Packs			Dimensions	
	Pack	Strips	Tags	H	W
MT2	1	10	100	4.9mm	5.8mm
MT3	1	20	100	5.0mm	10.0mm
MT4	1	10	100	5.0mm	4.8mm
MT5	1	10	100	9.5mm	4.5mm
MT6	1	10	100	9.5mm	5.6mm
MT8	1	10	100	10.5mm	7.5mm
MT9	1	10	100	10.3mm	8.7mm
MT10	1	20	100	10.4mm	9.5mm
MT12	1	20	100	10.4mm	11.4mm
MT16	1	20	100	10.5mm	15.4mm
MT2G	1	10	100	5.0mm	5.0mm
MT2B4	1	10	100	5.8mm	9.1mm
Continuous Tags					
MT6F	1	10	10	9.5mm	60.0mm
MT9F	1	10	10	10.3mm	90.0mm



HOW TO ORDER IMPRINTED MARKING TAGS

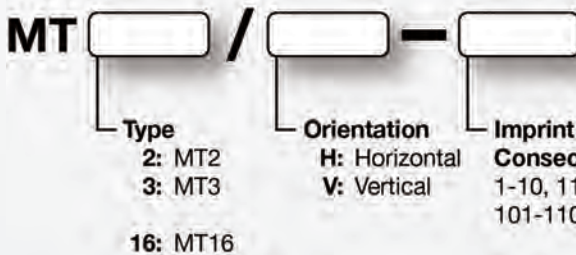

IMPRINT EXAMPLES FOR MT6

HORIZONTAL				VERTICAL			
Imprint	Cat. No.	Imprint	Cat. No.	Imprint	Cat. No.	Imprint	Cat. No.
1	MT6/H-1	131-140	MT6/H-131-140	1	MT6/V-1	131-140	MT6/V-131-140
2	MT6/H-2	141-150	MT6/H-141-150	2	MT6/V-2	141-150	MT6/V-141-150
3	MT6/H-3	151-160	MT6/H-151-160	3	MT6/V-3	151-160	MT6/V-151-160
4	MT6/H-4	161-170	MT6/H-161-170	4	MT6/V-4	161-170	MT6/V-161-170
5	MT6/H-5	171-180	MT6/H-171-180	5	MT6/V-5	171-180	MT6/V-171-180
6	MT6/H-6	181-190	MT6/H-181-190	6	MT6/V-6	181-190	MT6/V-181-190
7	MT6/H-7	191-200	MT6/H-191-200	7	MT6/V-7	191-200	MT6/V-191-200
8	MT6/H-8	1-100	MT6/H-1-100	8	MT6/V-8	1-100	MT6/V-1-100
9	MT6/H-9	1-50	MT6/H-1-50	9	MT6/V-9	1-50	MT6/V-1-50
10	MT6/H-10	A	MT6/H-A	10	MT6/V-10	A	MT6/V-A
1-10	MT6/H-1-10	B	MT6/H-B	1-10	MT6/V-1-10	B	MT6/V-B
11-20	MT6/H-11-20	C	MT6/H-C	11-20	MT6/V-11-20	C	MT6/V-C
21-30	MT6/H-21-30	L1	MT6/H-L1	21-30	MT6/V-21-30	L1	MT6/V-L1
31-40	MT6/H-31-40	L2	MT6/H-L2	31-40	MT6/V-31-40	L2	MT6/V-L2
41-50	MT6/H-41-50	L3	MT6/H-L3	41-50	MT6/V-41-50	L3	MT6/V-L3
51-60	MT6/H-51-60	N	MT6/H-N	51-60	MT6/V-51-60	N	MT6/V-N
61-70	MT6/H-61-70	R	MT6/H-R	61-70	MT6/V-61-70	R	MT6/V-R
71-80	MT6/H-71-80	S	MT6/H-S	71-80	MT6/V-71-80	S	MT6/V-S
81-90	MT6/H-81-90	X	MT6/H-X	81-90	MT6/V-81-90	X	MT6/V-X
91-100	MT6/H-91-100	Y	MT6/H-Y	91-100	MT6/V-91-100	Y	MT6/V-Y
101-110	MT6/H-101-110	Z	MT6/H-Z	101-110	MT6/V-101-110	Z	MT6/V-Z
111-120	MT6/H-111-120	Ground Symbol	MT6/H-GRND	111-120	MT6/V-111-120	Ground Symbol	MT6/V-GRND
121-130	MT6/H-121-130			121-130	MT6/V-121-130		

FREE Altech® PLOTTER

with **\$5000**
in annual
Terminal Block
purchases

FREE:
Altech®
CMPS Plotter Package
Cat. No. 34130020

**Comes with everything needed
to begin printing MT5,6,8,10,12
and 15 tags.**

- CMPS plotter
- Size: 17" x 18" x 4.9"
- CMPS software with cable
- 1 triple fixture for MT5, 6, 8, 10, 12 & 15
- 2 disposable pens



**Contact your local
Altech Representative
for the details.**

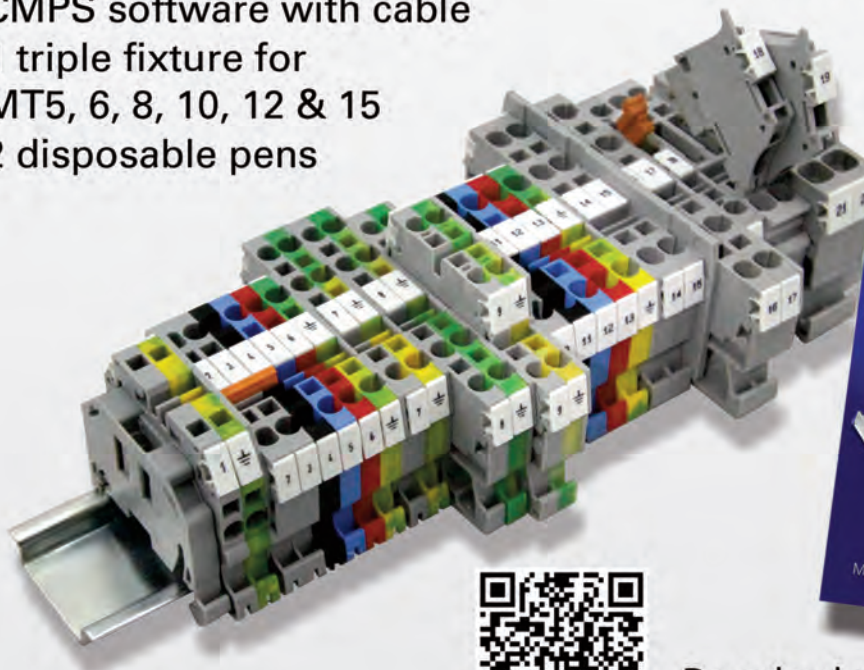

Download a
Marking System catalog today.

MARKING SYSTEMS

PLOTTERS

The Altech VP Series base unit is an auxiliary plotter that has to be connected to a PC via a USB connection. It is a high speed plotting device and enables plotting of different markers in one setting. The base unit is controlled through a PC with the help of Vario Sign software (sold separately). Manual available in English and Spanish.

The special design of the VP Series enables it to hold different markers from various manufacturers at the same time. It is also possible to write on relatively large markers with a maximum height of 10.5 mm.

PLOTTER VP 600 BASIC

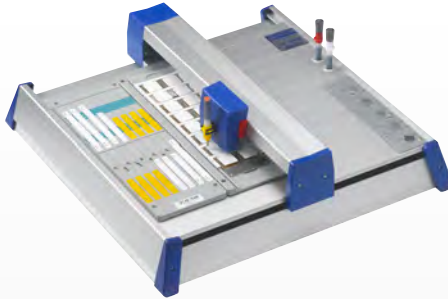

Ordering Information

Cat No. 34000082

- Professionally marking of connectors, wires, cables, equipment, cable ties, shrink tubing, labels and signs of different sizes and materials, as well as customer-specific items.
- Manual insertion of plotter pen
- Auto calibration
- Universal Power Supply 100-240V AC
- Control language HPGL
- Universal marking software (VarioSign) sold separately
- Marking area 273 x 305 mm
- Size: 18.5 x 18.9 x 6.1 in. (470 x 480 x 155 mm)
- Weight: 13.9 lbs.

PLOTTER VP 600 A3

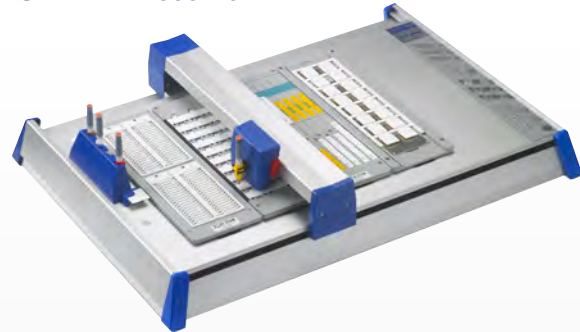

Ordering Information

Cat No. 34000080

- Basic features of plotter VP 600 Basic plus:
- Integrated and automated pen station. Holds 4 different pens at the same time, for fast and frequently changing applications.
- Built-in pen priming function
- Automatic recognition system for marking fixture / plates ensures faster and easier handling of frequently changing marking applications.
- Wide marking area 422 x 305 mm
- Size: 27.2 x 18.9 x 6.1 in. (690 x 480 x 155 mm)
- Weight: 18.3 lbs.

ACCESSORIES

PLOTTER PENS



Cat. No.	Description	Tip Size
35003018	Etching Plotter Pen (red)	0.18 mm
35003025	Etching Plotter Pen (white)	0.25 mm
35003035	Etching Plotter Pen (yellow)	0.35 mm
35003118	Non-Etching Plotter Pen (red)	0.18 mm
35003125	Non-Etching Plotter Pen (white)	0.25 mm
35003135	Non-Etching Plotter Pen (yellow)	0.35 mm

ALTECH FIXTURES



Cat. No.	Description
34902191	MT2G
34902081	MT2, MT3, MT4, MT2B4
34902001	MT5, MT6, MT8, MT10, MT12, MT16
34902057	MT9
34902080	MTG1, MTG2

* Fixtures for other Terminal Block Manufacturers are available, please contact Altech for additional information.

SOFTWARE



Cat. No.	Description
34000022	Variosign Software

Ferrules insure reliable electrical connections when terminating stranded flexible wire in terminal blocks, circuit breakers or other control devices.

Using ferrules offers several advantages:

ELIMINATE CROSS SHORTING

caused by unraveled stray wire strands.

IMPROVE TERMINAL CONNECTIONS

and reduce resistance by providing a solid surface at the point of connection.

REDUCE INSTALLATION TIME

by eliminating the need to dress loose wire strands and facilitating wire insertion into the terminal clamp.

PREVENT CONDUCTOR BREAKAGE

due to bending, wire stress or vibration.



Cutting and stripping the wire

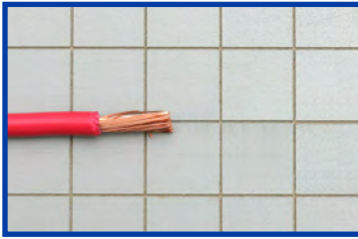

The wire should be cut as squarely and evenly as possible, taking care to avoid angular cuts or damage to the conductor. The strip length of the insulation will depend on the barrel length of the ferrule and the outside diameter of the wire.

Ideally the wire insulation should be stripped to a length that allows the conductor end to reach flush to the tip of the ferrule, when inserted. The end of the conductor should not extend more than .5mm past the tip of the ferrule.

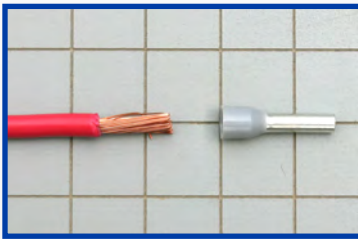
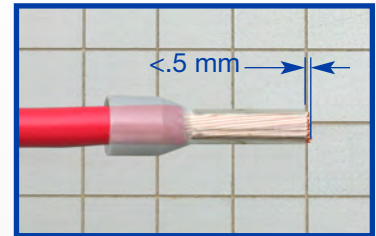

After the insulation is stripped, the strands of the conductor should be dressed by slightly twisting them to insure that any stray strands are consolidated.

The wire can then be inserted into the ferrule. The wire should be pushed in so that the insulation edge is fully covered by the plastic collar. The conductor should completely fill the metal tube and can extend up to .5mm past the tip.

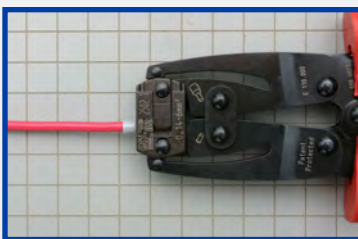
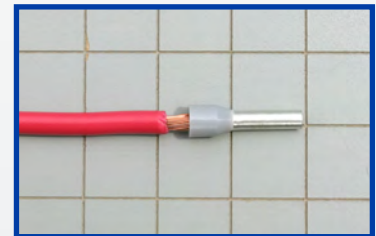

The ferrule and wire should be crimped with an appropriately sized ratcheted crimper. The ferrule should be inserted into the crimper die set and positioned so that only the metal tube is crimped. The crimping tool should be cycled completely to insure proper application.

The finished installation should then be checked for any obvious flaws in processing. An occasional pull test should be performed to check that the crimp tool is functioning properly.



HIGHLIGHTS

FEATURES

Ferrules insure reliable electrical connections when terminating stranded flexible wire in terminal blocks, circuit breakers or other control devices. Insulated ferrules prevent conductor breakage due to bending, wire stress or vibration while facilitating wire insertion into the terminal clamp.

Altech's UL insulated ferrules are color coded by conductor size for convenient identification.

To ensure efficient ferrule crimping, always select the smallest ferrule diameter that fits the wire and use only professional crimping tools.

In order meet the UL requirements only matching UL crimpers should be use.

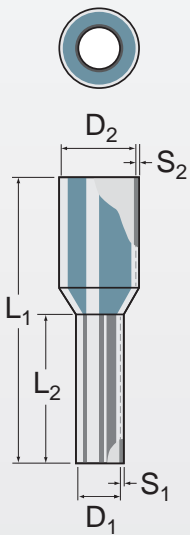

Standard Packaging

AWG	mm ²	L ₂ Barrel Length (mm)	Industry Standard color	Cat. No.	DIN Standard		Dimensions (mm)						Std. Pack
					color	Cat. No.	L ₁	L ₂	D ₁	S ₁	D ₂	S ₂	
26	0.14	6	grey	FII2606			10	6	0.6	0.15	1.5	0.25	500
26	0.14	8	grey	FII2608			12	8	0.6	0.15	1.5	0.25	500
24	0.25	6	light blue	FII2406			10	6	0.85	0.15	1.8	0.25	500
24	0.25	8	light blue	FII2408			12	8	0.85	0.15	1.8	0.25	500
24	0.25	12	light blue	FII2412			16	12	0.85	0.15	1.8	0.25	500
22	0.34	6	turquoise	FII2206			10	6	0.85	0.15	2	0.25	500
22	0.34	8	turquoise	FII2208			12	8	0.85	0.15	2	0.25	500
22	0.34	12	turquoise	FII2212			16	12	0.85	0.15	2	0.25	500
20	0.5	6	orange	FII2006	white	FID2006	12	6	1	0.15	2.6	0.25	500
20	0.5	8	orange	FII2008	white	FID2008	14	8	1	0.15	2.6	0.25	500
20	0.5	10	orange	FII2010	white	FID2010	16	10	1	0.15	2.6	0.25	500
20	0.5	12	orange	FII2012	white	FID2012	18	12	1	0.15	2.6	0.25	500
18	0.75	6	white	FII1806W	grey	FID1806GR	12	6	1.2	0.15	2.8	0.25	500
18	0.75	8	white	FII1808W	grey	FID1808GR	14	8	1.2	0.15	2.8	0.25	500
18	0.75	10	white	FII1810W	grey	FID1810GR	16	10	1.2	0.15	2.8	0.25	500
18	0.75	12	white	FII1812W	grey	FID1812GR	18	12	1.2	0.15	2.8	0.25	500
18	1	6	yellow	FII1806Y	red	FID1806R	12	6	1.4	0.15	3	0.25	500
18	1	8	yellow	FII1808Y	red	FID1808R	14	8	1.4	0.15	3	0.25	500
18	1	10	yellow	FII1810Y	red	FID1810R	16	10	1.4	0.15	3	0.25	500
18	1	12	yellow	FII1812Y	red	FID1812R	18	12	1.4	0.15	3	0.25	500
16	1.5	6	red	FII1606	black	FID1606	12	6	1.7	0.15	3.5	0.25	500
16	1.5	8	red	FII1608	black	FID1608	14	8	1.7	0.15	3.5	0.25	500
16	1.5	10	red	FII1610	black	FID1610	16	10	1.7	0.15	3.5	0.25	500
16	1.5	12	red	FII1612	black	FID1612	18	12	1.7	0.15	3.5	0.25	500
16	1.5	18	red	FII1618	black	FID1618	24	18	1.7	0.15	3.5	0.25	500
14	2.08	8	yellow	FII1408Y			15	8	2.05	0.15	4.2	0.3	500
14	2.5	6	blue	FID1406			13	6	2.2	0.15	4.2	0.25	500
14	2.5	8	blue	FID1408			15	8	2.2	0.15	4.2	0.25	500
14	2.5	10	blue	FID1410			17	10	2.2	0.15	4.2	0.25	500
14	2.5	12	blue	FID1412			19	12	2.2	0.15	4.2	0.25	500
14	2.5	18	blue	FID1418			25	18	2.2	0.15	4.2	0.25	500
12	4	8	grey	FID1208			16	8	2.8	0.2	4.8	0.3	500
12	4	10	grey	FID1210			18	10	2.8	0.2	4.8	0.3	500
12	4	12	grey	FID1212			20	12	2.8	0.2	4.8	0.3	500
12	4	18	grey	FID1218			26	18	2.8	0.2	4.8	0.3	100
10	6	12	black	FII1012	yellow	FID1012	20	12	3.5	0.2	6.3	0.3	100
10	6	18	black	FII1018	yellow	FID1018	26	18	3.5	0.2	6.3	0.3	100
8	10	12	ivory	FII0812	red	FID0812	22	12	4.5	0.2	7.6	0.4	100
8	10	18	ivory	FII0818	red	FID0818	28	18	4.5	0.2	7.6	0.4	100
6	16	12	green	FII0612	blue	FID0612	22	12	5.8	0.2	8.8	0.4	100
6	16	18	green	FII0618	blue	FID0618	28	18	5.8	0.2	8.8	0.4	100
4	25	16	brown	FII0416	yellow	FID0416	30	16	7.3	0.2	11.2	0.4	50
4	25	18	brown	FII0418	yellow	FID0418	32	18	7.3	0.2	11.2	0.4	50
4	25	22	brown	FII0422	yellow	FID0422	36	22	7.3	0.2	11.2	0.4	50
2	35	16	beige	FII0216	red	FID0216	30	16	8.3	0.2	12.7	0.4	50
2	35	18	beige	FII0218	red	FID0218	32	18	8.3	0.2	12.7	0.4	50
2	35	25	beige	FII0225	red	FID0225	39	25	8.3	0.2	12.7	0.4	50
1	50	20	olive	FII0120	blue	FID0120	36	20	10.3	0.3	15	0.5	50
1	50	25	olive	FII0125	blue	FID0125	41	25	10.3	0.3	15	0.5	50
1	50	30	olive	FII0130	blue	FID0130	46	30	10.3	0.3	15	0.5	50

Smaller Package Sizes

26	0.14	6	grey	FII2606M			10	6	0.6	0.15	1.5	0.25	100
26	0.14	8	grey	FII2608M			12	8	0.6	0.15	1.5	0.25	100
24	0.25	6	light blue	FII2406M			10	6	0.85	0.15	1.8	0.25	100
24	0.25	8	light blue	FII2408M			12	8	0.85	0.15	1.8	0.25	100
24	0.25	12	light blue	FII2412M			16	12	0.85	0.15	1.8	0.25	100
22	0.34	6	turquoise	FII2206M			10	6	0.85	0.15	2	0.25	100
22	0.34	8	turquoise	FII2208M			12	8	0.85	0.15	2	0.25	100
22	0.34	12	turquoise	FII2212M			16	12	0.85	0.15	2	0.25	100
20	0.5	6	orange	FII2006M	white	FID2006M	12	6	1	0.15	2.6	0.25	100
20	0.5	8	orange	FII2008M	white	FID2008M	14	8	1	0.15	2.6	0.25	100
20	0.5	10	orange	FII2010M	white	FID2010M	16	10	1	0.15	2.6	0.25	100
20	0.5	12	orange	FII2012M	white	FID2012M	18	12	1	0.15	2.6	0.25	100
18	0.75	6	white	FII1806WM	grey	FID1806GRM	12	6	1.2	0.15	2.8	0.25	100
18	0.75	8	white	FII1808WM	grey	FID1808GRM	14	8	1.2	0.15	2.8	0.25	100
18	0.75	10	white	FII1810WM	grey	FID1810GRM	16	10	1.2	0.15	2.8	0.25	100
18	0.75	12	white	FII1812WM	grey	FID1812GRM	18	12	1.2	0.15	2.8	0.25	100
18	1	6	yellow	FII1806YM	red	FID1806RM	12	6	1.4	0.15	3	0.25	100
18	1	8	yellow	FII1808YM	red	FID1808RM	14	8	1.4	0.15	3	0.25	100
18	1	10	yellow	FII1810YM	red	FID1810RM	16	10	1.4	0.15	3	0.25	100
18	1	12	yellow	FII1812YM	red	FID1812RM	18	12	1.4	0.15	3	0.25	100
16	1.5	6	red	FII1606M	black	FID1606M	12	6	1.7	0.15	3.5	0.25	100
16	1.5	8	red	FII1608M	black	FID1608M	14	8	1.7	0.15	3.5	0.25	100
16	1.5	10	red	FII1610M	black	FID1610M	16	10	1.7	0.15	3.5	0.25	100
16	1.5	12	red	FII1612M	black	FID1612M	18	12	1.7	0.15	3.5	0.25	100
14	2.08	8	yellow	FII1408YM			15	8	2.05	0.15	4.2	0.25	100
14	2.5	6	blue	FID1406M			13	6	2.2	0.15	4.2	0.25	100
14	2.5	8	blue	FID1408M			15	8	2.2	0.15	4.2	0.25	100
14	2.5	10	blue	FID1410M			17	10	2.2	0.15	4.2	0.25	100
14	2.5	12	blue	FID1412M			19	12	2.2	0.15	4.8	0.25	100
12	4	8	grey	FID1208M			16	8	2.8	0.2	4.8	0.3	50
12	4	10	grey	FID1210M			18	10	2.8	0.2	4.8	0.3	50
10	6	12	black	FII1012M	yellow	FID1012M	20	12	3.5	0.2	6.3	0.3	20
8	10	12	ivory	FII0812M	red	FID0812M	22	12	4.5	0.2	7.6	0.4	20

UL RECOGNIZED TWIN INSULATED FERRULES

Standard Packaging

AWG	mm ²	L ₂ Barrel Length (mm)	Industry Standard color Cat. No.	DIN Standard color Cat. No.	Dimensions (mm)							Std. Pack
					L ₁	L ₂	D ₁	S ₁	S ₂	A	B	
2 x 22	2 x 0.34	8	turquoise ● FTI2208		15	8	1.2	0.15	0.25	3.5	2	500
2 x 20	2 x 0.5	8	orange ● FTI2008	white ○ FTD2008	14	8	1.4	0.15	0.3	5	3	500
2 x 20	2 x 0.5	10	orange ● FTI2010	white ○ FTD2010	16	10	1.4	0.15	0.3	5	3	500
2 x 20	2 x 0.5	12	orange ● FTI2012	white ○ FTD2012	18	12	1.4	0.15	0.3	5	3	500
2 x 18	2 x 0.75	8	white ○ FTI1808W	grey ● FTD1808GR	14	8	1.7	0.15	0.3	5.5	3	500
2 x 18	2 x 0.75	10	white ○ FTI1810	grey ● FTD1810	16	10	1.7	0.15	0.3	5.5	3	500
2 x 18	2 x 0.75	12	white ○ FTI1812W	grey ● FTD1812GR	18	12	1.7	0.15	0.3	5.5	3	500
2 x 18	2 x 0.75	18	white ○ FTI1818W	grey ● FTD1818GR	24	18	1.7	0.15	0.3	5.5	3	500
2 x 18	2 x 1	8	yellow ● FTI1808Y	red ● FTD1808R	15	8	2	0.15	0.3	5.8	3.2	500
2 x 18	2 x 1	12	yellow ● FTI1812Y	red ● FTD1812R	19	12	2	0.15	0.3	5.8	3.2	500
2 x 18	2 x 1	14	yellow ● FTI1814	red ● FTD1814	21	14	2	0.15	0.3	5.8	3.2	500
2 x 18	2 x 1	18	yellow ● FTI1818Y	red ● FTD1818R	25	18	2	0.15	0.3	5.8	3.2	500
2 x 16	2 x 1.5	8	red ● FTI1608	black ● FTD1608	16	8	2.2	0.15	0.3	6.5	3.6	500
2 x 16	2 x 1.5	12	red ● FTI1612	black ● FTD1612	20	12	2.2	0.15	0.3	6.5	3.6	500
2 x 16	2 x 1.5	18	red ● FTI1618	black ● FTD1618	26	18	2.2	0.15	0.3	6.6	3.6	100
2 x 14	2 x 2.5	10	blue ● FTD1410		19	10	2.8	0.15	0.4	8	4.5	500
2 x 14	2 x 2.5	12	blue ● FTD1412		21	12	2.8	0.15	0.4	8	4.5	100
2 x 14	2 x 2.5	18	blue ● FTD1418		27	18	2.8	0.15	0.4	8	4.5	100
2 x 12	2 x 4	12	grey ● FTD1212		22	12	3.5	0.2	0.5	9	5.2	100
2 x 12	2 x 4	18	grey ● FTD1218		28	18	3.5	0.2	0.5	9	5.2	100
2 x 10	2 x 6	12	black ● FTI1012	yellow ● FTD1012	23	12	4.5	0.2	0.5	11.4	6.2	100
2 x 10	2 x 6	18	black ● FTI1018	yellow ● FTD1018	29	18	4.5	0.2	0.5	11.4	6.2	100
2 x 8	2 x 10	12	ivory ● FTI0812	red ● FTD0812	24	12	5.8	0.2	0.5	13.4	7.6	100
2 x 8	2 x 10	18	ivory ● FTI0818	red ● FTD0818	30	18	5.8	0.2	0.5	13.4	7.6	100
2 x 6	2 x 16	16	olive ● FTI0616	blue ● FTD0616	29	16	8.3	0.3	0.6	17.2	9.5	50
2 x 6	2 x 16	25	olive ● FTI0625	blue ● FTD0625	38	25	8.3	0.3	0.6	17.2	9.5	50

Smaller Package Sizes

2 x 22	2 x 0.34	8	turquoise ● FTI2208M		15	8	1.2	0.15	0.25	3.5	2	100
2 x 20	2 x 0.5	8	orange ● FTI2008M	white ○ FTD2008M	14	8	1.4	0.15	0.3	5	3	100
2 x 20	2 x 0.5	10	orange ● FTI2010M	white ○ FTD2010M	16	10	1.4	0.15	0.3	5	3	100
2 x 20	2 x 0.5	12	orange ● FTI2012M	white ○ FTD2012M	18	12	1.4	0.15	0.3	5	3	100
2 x 18	2 x 0.75	8	white ○ FTI1808WM	grey ● FTD1808GRM	14	8	1.7	0.15	0.3	5.5	3	100
2 x 18	2 x 0.75	10	white ○ FTI1810M	grey ● FTD1810M	16	10	1.7	0.15	0.3	5.5	3	100
2 x 18	2 x 0.75	12	white ○ FTI1812WM	grey ● FTD1812GRM	18	12	1.7	0.15	0.3	5.5	3	100
2 x 18	2 x 1	8	yellow ● FTI1808YM	red ● FTD1808RM	15	8	2	0.15	0.3	5.8	3.2	100
2 x 18	2 x 1	12	yellow ● FTI1812YM	red ● FTD1812RM	19	12	2	0.15	0.3	5.8	3.2	100
2 x 16	2 x 1.5	8	red ● FTI1608M	black ● FTD1608M	16	8	2.2	0.15	0.3	6.5	3.6	100
2 x 16	2 x 1.5	12	red ● FTI1612M	black ● FTD1612M	20	12	2.2	0.15	0.3	6.5	3.6	100
2 x 14	2 x 2.5	10	blue ● FTD1410M		19	10	2.8	0.15	0.4	8	4.5	50
2 x 14	2 x 2.5	12	blue ● FTD1412M		21	12	2.8	0.15	0.4	8	4.5	50
2 x 12	2 x 4	12	grey ● FTD1212M		22	12	3.5	0.2	0.5	9	5.2	20
2 x 10	2 x 6	12	black ● FTI1012M	yellow ● FTD1012M	23	12	4.5	0.2	0.5	11.4	6.2	20
2 x 8	2 x 10	12	ivory ● FTI0812M	red ● FTD0812M	24	12	5.8	0.2	0.5	13.4	7.6	20

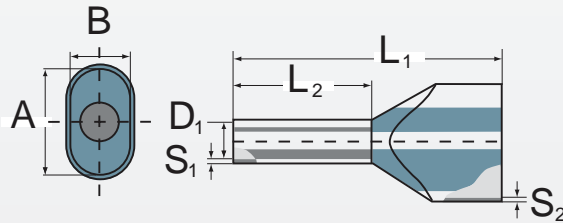

Pull-Out Force Minimum Values for DIN

Minimum values of pull-out forces for FERRULES according to DIN EN 60947-1:2008, DIN EN 60999-1:2000 and DIN EN 60999-2:2004

Conductor	AWG	24	22	20	18	18	16	14	12	10	8	6	4	2	0	00	000	250	300	350	500	600
																		kcmil	kcmil	kcmil	kcmil	kcmil
Cross Section	mm ²	0,20	0,34	0,50	0,75	1,0	1,5	2,5	4,0	6,0	10	16	25	35	50	70	95	120	150	185	240	300
Pull Out Force	N	10	15	20	30	35	40	50	60	80	90	100	135	190	236	285	351	427	427	503	578	578

Pull-Out Force Minimum Values for UL486F

Conductor	AWG	24	22	20	18	18	16	14	12	10	8	6	4	2
Cross Section	mm ²	0,20	0,34	0,50	0,75	1,0	1,5	2,5	4,0	6,0	10	16	25	35
Pull Out Force	N	20	20	20	30	35	40	50	60	80	90	100	135	190
	Pounds	4.5	4.5	4.5	6.7	7.9	9.0	11.2	13.5	18	20.2	22.5	30.3	42.7

HIGHLIGHTS

FEATURES

Ferrules insure reliable electrical connections when terminating stranded flexible wire in terminal blocks, circuit breakers or other control devices. Insulated ferrules prevent conductor breakage due to bending, wire stress or vibration while facilitating wire insertion into the terminal clamp.

Altech's UL insulated ferrules are color coded by conductor size for convenient identification.

To ensure efficient ferrule crimping, always select the smallest ferrule diameter that fits the wire and use only professional crimping tools.

In order meet the UL requirements only matching UL crimpers should be use.



These crimpers are specifically designed for use with ferrules and have been tested with our UL Recognized ferrules to insure proper termination. In order to meet the UL requires, the correct sized crimper from this range should be used.



Crimpit F 4

Crimping tool for ferrules (according to DIN 46228 part 1 and 4) with or without plastic collars. Only one crimping profile for the entire cross-section range.

Ferrules: 0,5 – 4 mm² (20 – 12 AWG)

Twin Ferrules: 2 x 0.5 – 2 x 2.5 mm² (2 x 20 – 2 x 14 AWG)

Cat. No.: Crimpit F 4

Weight 448 g



Crimpit F 6 Auto

Crimping tool for ferrules (according to DIN 46228 part 1 and 4) with and without plastic collars. Feeding from front.

Ferrules: 0,5 – 6 mm² (20 – 10 AWG)

Twin Ferrules: 2 x 0.5 – 2 x 2.5 mm² (2 x 20 – 2 x 14 AWG)

Cat. No.: Crimpit F 6 Auto

Weight 426 g



Crimpit F 6 Gyra

Crimping tool for ferrules (according to DIN 46228 part 1 and 4) with and without plastic collars. Rotatable crimp die for feeding from the front or the side.

Ferrules: 0,14 – 6 mm² (26 – 10 AWG)

Twin Ferrules: 2 x 0.5 – 2 x 4 mm² (2 x 20 – 2 x 12 AWG)

Cat. No.: Crimpit F 6 Gyra

Weight 428 g



Crimpit F 6 EN

Crimping tool for ferrules (according to DIN 46228 part 1 and 4) with and without plastic collars. Crimp conforms to EN 60947-1. Five crimping profiles for the rated conductor cross-sections. Registration in accordance with VG 95211 (Military designation VG 95236 T 14 A 0001).

Ferrules: 0.25 – 6 mm² (24 – 10 AWG)

Twin Ferrules: 2 x 0.75 – 2 x 4 mm² (2 x 18 – 2 x 12 AWG)

Cat. No.: Crimpit F 6 EN

Weight 423 g



Crimpit F 6 L

Crimping tool for ferrules (conforming to DIN 46228 part 1 and 2) with and without insulating collar. Five crimping profiles depending on the wire cross-sections.

Ferrules: 0.5 – 6 mm² (20 – 10 AWG)

Twin Ferrules: 2 x 0.75 – 2 x 4 mm² (2 x 18 – 2 x 12 AWG)

Cat. No.: Crimpit F 6 L

Weight 335 g

CRIMPERS FOR UL FERRULES



Crimpit F 16

Crimping tool for ferrules (according to DIN 46228 part 1 and 4) with and without plastic collars. Crimp conforms to EN 60947-1. Three crimping profiles for the rated conductor cross-sections. Registration in accordance with VG 95211 (Military designation VG 95236 T 14 A 0002).

Ferrules: 6 – 16 mm² (10 – 6 AWG)

Cat. No.: Crimpit F 16

Weight 418 g



Crimpit F 16 L

Crimping tool for ferrules (according to DIN 46228 part 1 and 4) with and without plastic collars. Crimp conforms to EN 60947-1. Three crimping profiles for the rated conductor cross-sections.

Ferrules: 6 – 16 mm² (10 – 6 AWG)

Cat. No.: Crimpit F 16 L

Weight 380 g



Crimpit F 25 L

Crimping tool for ferrules (according to DIN 46228 part 1 and 4) as well as for twin ferrules.

Ferrules: 6 – 25 mm² (10 – 4 AWG)

Twin Ferrules: 2 x 4 – 2 x 10 mm² (2 x 12 – 2 x 8 AWG)

Cat. No.: Crimpit F 25 L

Weight 540 g



Crimpit F 50 L

Crimping tool for ferrules (according to DIN 46228 part 1 and 4) as well as for twin ferrules.

Ferrules: 35 – 50 mm² (2 – 1 AWG)

Twin Ferrules: 2 x 16 mm² (2 x 6 AWG)

Cat. No.: Crimpit F 50 L

Weight 540 g

Crimper Selection Guide

Single Wire		Dual Wire		Crimpit F4	Crimpit F6 Gyra	Crimpit F6 EN	Crimpit F6 Auto	Crimpit F6L	Crimpit F16/F16L	Crimpit F25L	Crimpit F50L
AWG	mm ²	AWG	mm ²								
26	0.14										
24	0.25										
22	0.34										
20	0.5										
18	0.75	2 x 22	2 x 0.34								
18	1.0	2 x 20	2 x 0.5								
16	1.5	2 x 18	2 x 0.75								
14	2.5	2 x 16	2 x 1.5								
12	4	2 x 14	2 x 2.5								
10	6	2 x 12	2 x 4								
8	10	2 x 8	2 x 6								
6	16										
4	25	2 x 6	2 x 10								
2	35										
1	50										

Cutter, Stripper and Crimper

This one tool will cut and strip the wires and uses belt feed ferrules for fast and easy installation.



Crimpit F Multi

Multi-function tool. Stripping and cutting of wires. Crimping tool for insulated belt-strip ferrules according to DIN 40228.

Cross-section: 0.5 – 2.5 mm² (20 – 14 AWG)

Ferrules: 0.5 x 2.5 mm² (20 x 14 AWG)

Cat. No.: Crimpit F Multi

Weight 200 g

UL Recognized Insulated Belt Strip Ferrules

AWG	mm ²	Barrel Length (mm)	Industry Standard color	Industry Standard Cat. No.	DIN Standard color	DIN Standard Cat. No.	Std. Pack
20	0.5	8	orange	● FII2008B	white	○ FID2008B	10 x 50
18	0.75	8	white	○ FII1808WB	grey	● FID1808GRB	10 x 50
18	1	8	yellow	● FII1808YB	red	● FID1808RB	10 x 50
16	1.5	8	red	● FII1608B	black	● FID1608B	10 x 50
14	2.5	8		blue ● FID1408B			10 x 50

AUTOMATED FERRULE CRIMPING MACHINES



For technical and ordering information regarding Ferrule Crimping Machines please contact Altech.

Original Industry Standard Ferrules

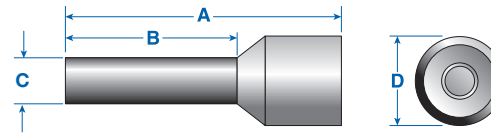

Tested According To:

- CSA Std C22.2 No. 65-93 - Wire Connectors
- CSA Std C22.2 No. 188-M1983 - Splicing Wire and Cable Connectors
- ANSI/UL Std No. 486A - Wire Connectors and Soldering Lugs for Use with Copper Conductors
- ANSI/UL Std No. 486C - Splicing Wire Connectors

	AWG	mm ²	Color	Cat. No.	Barrel Length (B) mm	Ferrule Dimensions mm				Std. Pack*
						A	B	C	D	
	24	0.25	Lt. Blue	2620.0	6	10	6	1.2	2.3	500/100
	24	0.25	Lt. Blue	2621.0	8	12	8	1.2	2.3	500/100
	22	0.34	Turquoise	2622.0	6	10	6	1.2	2.5	500/100
	22	0.34	Turquoise	2623.0	8	12	8	1.2	2.5	500/100
	20	0.5	Orange	2397.0	6	12	6	1.3	2.8	500/100
	20	0.5	Orange	2201.0	8	14	8	1.3	2.8	500/100
	18	0.75	White	2398.0	6	12	6	1.5	3.3	500/100
	18	0.75	White	2202.0	8	14	8	1.5	3.3	500/100
	18	1	Yellow	2399.0	6	12	6	1.7	3.5	500/100
	18	1	Yellow	2203.0	8	14	8	1.7	3.5	500/100
	16	1.5	Red	2204.0	8	14	8	2.0	4.0	500/100
	16	1.5	Red	2400.0	10	16	10	2.0	4.0	500/100
	16	1.5	Red	2205.0	18	24	18	2.0	4.0	500/100
	14	2.5	Blue	2206.0	8	14	8	2.5	4.7	500/100
	14	2.5	Blue	2401.0	12	18	12	2.5	4.7	500/100
	14	2.5	Blue	2207.0	18	24	18	2.5	4.7	500/100
	12	4	Gray	2208.0	10	17	10	3.2	5.4	500/100
	12	4	Gray	2402.0	12	20	12	3.2	5.4	500/100
	12	4	Gray	2209.0	18	26	18	3.2	5.4	100
	10	6	Black	2210.0	12	20	12	3.9	6.9	100
	10	6	Black	2211.0	18	26	18	3.9	6.9	100
	8	10	Ivory	2212.0	12	22	12	4.9	8.4	100
	8	10	Ivory	2213.0	18	28	18	4.9	8.4	100
	6	16	Green	2214.0	12	24	12	6.2	9.6	100
	6	16	Green	2215.0	18	28	18	6.2	9.6	100
	4	25	Brown	2267.0	18	30	18	7.7	12.0	50
	4	25	Brown	2272.0	22	36	22	7.7	12.0	50
	2	35	Beige	2276.0	18	30	18	8.7	13.5	50
	2	35	Beige	2390.0	25	39	25	8.7	13.5	50
	1	50	Olive	2500.0	20	36	20	10.9	16.0	50
	2/0	70	Yellow	2786.0	20	37	20	13.4	17.0	25
	3/0	95	Red	2787.0	25	44	25	15.4	19.0	5
	4/0	120	Blue	2788.0	27	48	27	17.6	22.4	25
	250MCM	150	Yellow	2789.0	32	58	32	20.5	25.0	25

HIGHLIGHTS

FEATURES

Ferrules insure reliable electrical connections when terminating stranded flexible wire in terminal blocks, circuit breakers or other control devices. Insulated ferrules prevent conductor breakage due to bending, wire stress or vibration while facilitating wire insertion into the terminal clamp.

Altech's standard insulated ferrules are color coded by conductor size for convenient identification.

To ensure efficient ferrule crimping, always select the smallest ferrule diameter that fits the wire and use only professional crimping tools.

- Sleeve: polypropylene
- Tube: tin-plated copper

**CRIMPER
SELECTOR
GUIDE**
page 18

* Different standard packs are available as shown. To order the desired standard pack, please use the quantity required as a suffix to the cat. no.
Example for 100 standard pack: Cat. No. 2620.0/100

HIGHLIGHTS

FEATURES

Ferrules insure reliable electrical connections when terminating stranded flexible wire in terminal blocks, circuit breakers or other control devices.

Insulated ferrules prevent conductor breakage due to bending, wire stress or vibration while facilitating wire insertion into the terminal clamp.

Altech's DIN standard ferrules are in compliance with DIN requirements, making them ideal for export applications. They also have a specified color code convention that differs from the color code used for Altech's industry standard ferrules.

To ensure efficient ferrule crimping, always select the smallest ferrule diameter that fits the wire and use only professional crimping tools.

- Sleeve: polypropylene
- Tube: tin plated copper

**CRIMPER
SELECTOR
GUIDE**
page 18

Original DIN Standard Ferrules

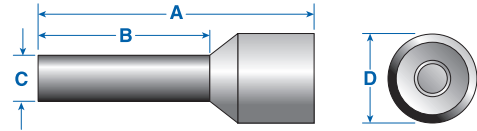

Tested According To:

- | | |
|-----------------------------|---|
| CSA Std C22.2 No. 65-93 | - Wire Connectors |
| CSA Std C22.2 No. 188-M1983 | - Splicing Wire and Cable Connectors |
| ANSI/UL Std No. 486A | - Wire Connectors and Soldering Lugs for Use with Copper Conductors |
| ANSI/UL Std No. 486C | - Splicing Wire Connectors |

	AWG	mm ²	Cat. Color	No.	Barrel Length (B) mm	Ferrule Dimensions mm				Std. Pack*
						A	B	C	D	
	20	0.50	White	2863.0	6	12	6	1.3	2.8	500/100
	20	0.50	White	2864.0	8	14	8	1.3	2.8	500/100
	20	0.50	White	2865.0	10	16	10	1.3	2.8	500/100
	18	0.75	Gray	2866.0	6	12	6	1.5	3.3	500/100
	18	0.75	Gray	2867.0	8	14	8	1.5	3.3	500/100
	18	0.75	Gray	2868.0	10	16	10	1.5	3.3	500/100
	18	0.75	Gray	2869.0	12	18	12	1.5	3.3	500/100
	18	1	Red	2870.0	6	12	6	1.7	3.5	500/100
	18	1	Red	2871.0	8	14	8	1.7	3.5	500/100
	18	1	Red	2872.0	10	16	10	1.7	3.5	500/100
	18	1	Red	2840.0	12	18	12	1.7	3.5	500/100
	16	1.5	Black	2841.0	8	14	8	2	4	500/100
	16	1.5	Black	2842.0	10	16	10	2	4	500/100
	16	1.5	Black	2843.0	12	18	12	2	4	500/100
	16	1.5	Black	2844.0	18	24	18	2	4	500/100
	14	2.5	Blue	2845.0	8	14	8	2.5	4.7	500/100
	14	2.5	Blue	2846.0	12	18	12	2.5	4.7	500/100
	14	2.5	Blue	2847.0	18	24	8	2.5	4.7	500/100
	12	4	Gray	2848.0	10	17	10	3.2	5.4	500/100
	12	4	Gray	2849.0	12	20	12	3.2	5.4	500/100
	12	4	Gray	2850.0	18	26	18	3.2	5.4	100
	10	6	Yellow	2851.0	12	20	12	3.9	6.9	100
	10	6	Yellow	2852.0	18	26	18	3.9	6.9	100
	8	10	Red	2853.0	12	22	12	4.9	8.4	100
	8	10	Red	2854.0	18	28	18	4.9	8.4	100
	6	16	Blue	2855.0	12	24	12	6.2	9.6	100
	6	16	Blue	2856.0	18	28	18	6.2	9.6	100
	4	25	Yellow	2857.0	18	30	18	7.7	12	50
	4	25	Yellow	2858.0	22	36	22	7.7	12	50
	2	35	Red	2859.0	18	30	18	8.7	13.5	50
	2	35	Red	2860.0	25	39	25	8.7	13.5	50
	1	50	Blue	2861.0	20	36	20	10.9	16	50

* Different standard packs are available as shown. To order the desired standard pack, please use the quantity required as a suffix to the cat. no.
Example for 100 standard pack: Cat. No. 2863.0/100

Original Dual Wire Ferrules

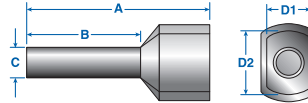

Tested According To:

- CSA Std C22.2 No. 65-93 - Wire Connectors
- CSA Std C22.2 No. 188-M1983 - Splicing Wire and Cable Connectors
- ANSI/UL Std No. 486A - Wire Connectors and Soldering Lugs for Use with Copper Conductors
- ANSI/UL Std No. 486C - Splicing Wire Connectors

Wires x AWG	mm²	Color	Cat. No.	Barrel Length (B) mm	Ferrule Dimensions mm					Std. Pack*
					A	B	C	D1	D2	
2x20	2x0.50	White	2794.0	11	14.6	8.2	1.7	3	5	500/100
2x18	2x0.75	Gray	2775.0	11	14.6	8.2	2.0	3	5.5	500/100
2x18	2x0.75	Gray	2795.0	13	16.4	10	2.0	3	5.5	500/100
2x18	2x1	Red	2776.0	11	15.4	8.2	2.4	3.2	5.8	500/100
2x18	2x1	Red	2796.0	21	25.2	18	2.4	3.2	5.8	500/100
2x16	2x1.5	Black	2777.0	12	15.8	8.2	2.6	3.6	6.5	500/100
2x16	2x1.5	Black	2797.0	16	19.6	12	2.6	3.6	6.5	500/100
2x14	2x2.5	Blue	2778.0	14	18.5	10	3.3	4.5	8	500/100
2x14	2x2.5	Blue	2798.0	17	20.5	12	3.3	4.5	8	500/100
2x12	2x4	Gray	2799.0	16	22	12	3.9	5.2	9	100
2x10	2x6	Yellow	2800.0	18	23	12	5	6.2	11.4	100
2x8	2x10	Red	2801.0	18	24	12	6.2	7.6	13.4	100
2X6	2x16	Blue	2802.0	20	29	16	8.9	9.5	17.2	100/50

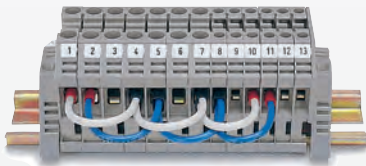

* Different standard packs are available for many ferrules. To order the desired standard pack, please use the quantity required as a suffix to the Cat. No.

Example: Cat. No. 2794.0/100 for a standard pack of 100

Ferrule Qty.	AWG	mm²	Ferrule Cat. No.	Ferrule Color	Type	Cat. No.	Std. Pack
AB1-S Industry Standard					AB1-S	2884.9	1
50	20	0.5	2201.0	Orange			
100	20	0.75	2202.0	White			
100	18	1	2399.0	Yellow			
100	16	1.5	2204.0	Red			
50	14	2.5	2206.0	Blue			
AB2-S Industry Standard					AB2-S	2885.9	1
50	12	4	2208.0	Gray			
20	10	6	2210.0	Black			
20	8	10	2212.0	Ivory			
10	6	16	2214.0	Green			
AB1-D DIN Standard					AB1-D	2884.0	1
50	20	0.5	2864.0	White			
100	20	0.75	2867.0	Gray			
100	18	1	2871.0	Red			
100	16	1.5	2841.0	Black			
50	14	2.5	2845.0	Blue			
AB2-D DIN Standard					AB2-D	2885.0	1
50	12	4	2848.0	Gray			
20	10	6	2851.0	Yellow			
20	8	10	2853.0	Red			
10	6	16	2855.0	Blue			

HIGHLIGHTS

FEATURES

Dual Wire Insulated

Dual Wire Ferrules have larger diameters and special shaped sleeves that accept two conductors of the same or different size. They provide an efficient connection of multiple wires in the same terminal clamp or simplify wire jumpering between terminal clamps. They are color coded with the same convention as the insulated DIN standard ferrules.

To ensure efficient ferrule crimping always select the smallest ferrule diameter that fits the wire and use only professional crimping tools.

- Sleeve: polypropylene
- Tube: tin plated copper

INSULATED FERRULES Assortment Box

Handy Assortment Boxes for convenient dispensing and storage of Industry and DIN Standard Insulated Ferrules. Types AB1-S and AB1-D are equipped with five different ferrule sizes. Types AB2-S and AB2-D are equipped with four different ferrule sizes. Contents of each box is listed.

CRIMPER SELECTOR GUIDE page 18



HIGHLIGHTS

FEATURES

Ferrules insure reliable electrical connections when terminating stranded flexible wire in terminal blocks, circuit breakers or other control devices.

Uninsulated ferrules prevent wire strands from fraying and breaking and are extremely cost effective. Their shorter lengths and uninsulated bodies offer advantages when making terminations in printed circuit board terminal blocks and in other terminal blocks with smaller clamps or narrow widths.

To ensure efficient ferrule crimping, always select the smallest ferrule diameter that fits the wire and use only professional crimping tools. (Please refer to the ordering pages and the Crimper Selector Guide on page 18.)

- Tube: tin plated copper

Original Uninsulated Ferrules



Tested According To:

- | | |
|-----------------------------|---|
| CSA Std C22.2 No. 65-93 | - Wire Connectors |
| CSA Std C22.2 No. 188-M1983 | - Splicing Wire and Cable Connectors |
| ANSI/UL Std No. 486A | - Wire Connectors and Soldering Lugs for Use with Copper Conductors |
| ANSI/UL Std No. 486C | - Splicing Wire Connectors |

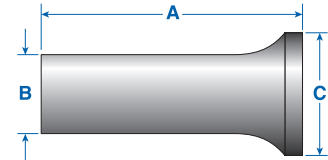

AWG	mm ²	Cat. No.	Barrel Length (A)		Ferrule Dimensions mm			Std. Pack*
			mm	A	B (ID)	C		
20	0.5	2216.0	6	6	1.3	2.1	1000/100	
18	0.75	2217.0	6	6	1.5	2.3	1000/100	
18	0.75	2218.0	10	10	1.5	2.3	1000/100	
18	1	2219.0	6	6	1.7	2.5	1000/100	
18	1	2220.0	10	10	1.7	2.5	1000/100	
16	1.5	2221.0	7	7	2.3	2.8	1000/100	
16	1.5	2222.0	10	10	2.3	2.8	1000/100	
14	2.5	2223.0	7	7	2.5	3.4	1000/100	
14	2.5	2224.0	12	12	2.5	3.4	1000/100	
12	4	2225.0	9	9	3.2	4.0	1000/100	
12	4	2226.0	12	12	3.2	4.0	1000/100	
10	6	2227.0	12	12	3.9	4.7	500/100	
10	6	2388.0	15	15	3.9	4.7	500/100	
8	10	2228.0	12	12	4.9	5.8	500/100	
8	10	2389.0	15	15	4.9	5.8	500/100	
8	10	2229.0	18	18	4.9	5.8	500/100	
6	16	2391.0	12	12	6.2	7.5	500/100	
6	16	2392.0	15	15	6.2	7.5	500/100	
6	16	2393.0	18	18	6.2	7.5	100	
4	25	2394.0	15	15	7.7	9.5	500/100	
4	25	2395.0	18	18	7.7	9.5	100	
2	35	2396.0	18	18	8.7	11	100	
1	50	2816.0	32	32	10.9	13	100	
2/0	70	2790.0	25	25	13.3	15	100	
3/0	95	2791.0	32	32	15.3	17	50	
4/0	120	2792.0	32	32	17.5	19	25	
250MCM	150	2793.0	32	32	19.5	21	25	
350MCM	185	2815.0	32	32	21.2	23.5	25	
500MCM	240	2815.5	40	40	23.0	25	25	

CRIMPER SELECTOR GUIDE page 118, 119, 125 and 126

* Different standard packs are available as shown. To order the desired standard pack, please use the quantity required as a suffix to the cat. no.
Example for 100 standard pack: Cat. No. 2216.0/100

UNIVERSAL CRIMPERS FOR ORIGINAL FERRULES

Universal Ferrule Crimpers for Original Ferrules

Front Conductor Entry

One die crimps a wide range of insulated and uninsulated ferrule sizes. Three Universal Ferrule Crimpers are offered to crimp different ferrule and wire size ranges up to 16mm² (6 AWG).

- Positive ratcheting with spring return
- Trapezoidal crimp geometry
- Comfort grip plastic handle
- Hardened steel frame, matte black

Universal Ferrule Crimper



Part No.	Wire/ AWG	Ferrule mm ²	Std. Pack
----------	--------------	----------------------------	--------------

E110.000	26 - 10	0.14 - 6	1
----------	---------	----------	---

Replacement Spring Set:

185140008	Handle Spring Set
318001002	Ratchet Spring

Universal Ferrule Crimper



Part No.	Wire/ AWG	Ferrule mm ²	Std. Pack
----------	--------------	----------------------------	--------------

E110.005	20 - 8	0.5 - 10	1
----------	--------	----------	---

Replacement Spring Set:

185140008	Handle Spring Set
318001002	Ratchet Spring

Universal Ferrule Crimper



Part No.	Wire/ AWG	Ferrule mm ²	Std. Pack
----------	--------------	----------------------------	--------------

E110.010	8 - 6	10 - 16	1
----------	-------	---------	---

Replacement Spring Set:

185140008	Handle Spring Set
318001002	Ratchet Spring

Ferrule Crimper

Side Conductor Entry

Individual crimp cavities conform to industry standard insulated and uninsulated ferrules from 25-50mm² (4-1 AWG).

- Positive ratcheting with spring return
- Emergency release
- Trapezoidal crimp geometry
- Comfort grip plastic handle
- Hardened steel frame, matte black

Ferrule Crimper



Part No.	Wire/ AWG	Ferrule mm ²	Std. Pack
----------	--------------	----------------------------	--------------

E110.015	4 - 2	25 - 35	1
----------	-------	---------	---

Ferrule Crimper



Part No.	Wire/ AWG	Ferrule mm ²	Std. Pack
----------	--------------	----------------------------	--------------

E110.020	1	50	1
----------	---	----	---

Vise Mount Ferrule Crimper

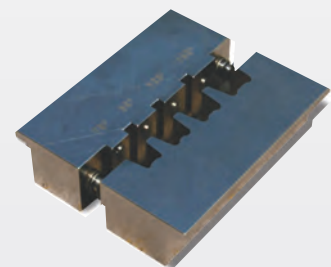

Part No.	Wire/ AWG	Ferrule mm ²	Std. Pack
----------	--------------	----------------------------	--------------

22.030	2/0-250 MCM	70 - 150	1
--------	----------------	----------	---

HIGHLIGHTS

FEATURES

Altech's pneumatic crimping tools speed the crimping process of insulated or uninsulated ferrules for a wide range of wire sizes up to 8 AWG.

Altech pneumatic crimpers are simple and easy to use. Just install the ferrule over the end of the stripped wire and insert it into either the front or side tool opening. Then touch the actuating lever or push the foot switch pedal to initiate the crimp cycle. Once the head closes it will automatically re-open after crimping. The resulting crimp features a compact trapezoidal cross section which is mechanically very strong and provides a large surface to insure a highly efficient electrical contact.

Crimp ferrules efficiently and economically. A unique dual crimping head provides convenient front or side wire entry, allowing crimping from multiple positions. This feature makes crimping in tight places simple.

Choose either lever actuated, hand held units or hands-free foot switch operated table top models, in two basic tool sizes. Hand held models feature a flexible coil air hose with 1/4" NPT interchange connector for quick hook-up with a standard push-to-connect coupler.

The table top units also include a flexible coil air hose to the foot switch and a 1/4" NPT interchange located on the foot switch for one hand push-to-connect supply hook-up. They feature a sturdy metal base with integral table clamp and dual storage trays for quick access to the ferrule supply. The air release port on the foot switch has been quieted with a sintered bronze air silencer. The foot switch has a metal frame and a tough fiberglass shroud. Its spring return pedal provides for short actuating cycles.

Optional items for the hand held crimper include a counterbalance for maximum control and a magnetic holder for storage.

Pneumatic Crimping Tool for Original Ferrules



- Operates on 60 - 90 psi air supply
- Crimp insulated and uninsulated ferrules
- Trapezoidal crimp geometry
- Flexible coil air hose with 1/4" NPT interchange
- Metal tool body and base
- Hardened steel crimp head

Tool	Wire/ Ferrule Size AWG	mm ²	Cat. No.	Tool Wt. g (lbs.)	Std. Pack
Hand Held Crimper with Actuating Lever Crimp Insulated Ferrules and Uninsulated Ferrules	24-14	0.25-2.5	22.014	430 (.95)	1
Hand Held Crimper with Actuating Lever Crimp Insulated Ferrules and Uninsulated Ferrules	12-8	4-10	22.015	430 (.95)	1
Table Top Crimper with Foot Switch and Storage Trays Crimp Insulated Ferrules and Uninsulated Ferrules	24-14	0.25-2.5	22.016	1000 (2.20)	1
Table Top Crimper with Foot Switch and Storage Trays Crimp Insulated Ferrules and Uninsulated Ferrules	12-8	4-10	22.017	1000 (2.20)	1
Magnetic Mounting Holder <i>for hand held pneumatic crimpers</i>			22.018	---	1
Counterbalance <i>for hand held pneumatic crimpers</i>			22.019	---	1

Original Ferrule and Wire Size by Crimper Type

Use this Selector Guide to determine ferrule and wire sizes which can be crimped. Refer to following pages for selection and ordering information of crimpers.

1. Determine the wire size(s) to be used.
2. To insure efficient ferrule crimping, always select the smallest ferrule diameter that fits the wire.
3. Based on the ferrule size, choose the crimper type appropriate for use.
4. Select the crimper style best suited for your application.

		CRIMPER STYLES										
		UNIVERSAL FERRULE CRIMPER					PNEUMATIC FERRULE CRIMPER			WISE MOUNT FERRULE CRIMPER		
Wire Size AWG	Ferrule Size mm ²	Crimper Type	E110.000	E110.005	E110.010	E110.015	E110.020	22.014 *	22.015	22.016 *	22.017	22.030
26	0.14		■									
24	0.25						■					
22	0.34		■									
20	0.50			■								
20	0.75											
18	1						■					
16	1											
14	2.5							■				
12	4								■			
10	6		■									
8	10			■								
6	16				■							
4	25					■						
2	35						■					
1	50											
2/0	70											■
3/0	95											
4/0	120											
250MCM	150											■

Dual Wire Ferrules

E110.000 crimper covers 2x20 to 2x12 AWG dual wire ferrules

E110.010 crimper covers 2x10 to 2x8 AWG dual wire ferrules

E110.015 crimper covers 2x6 AWG dual wire ferrules

Key:

■ = Cavity Range

* Insulated ferrule/wire size range is shown, uninsulated ferrule range is 16-14 AWG (1.5 - 2.5mm²).

Cat. No.	Page	Cat. No.	Page	Cat. No.	Page	Cat. No.	Page
40.002.....	102	40.406.....	102	AGT2.5.....	84	CA512/17-3.....	61
40.003.....	102	40.407.....	102	AGT2.5/3.....	84	CA512/17-4.....	61
40.004.....	102	40.408.....	102	AGT2.5/4.....	85	CA512/2-2.....	61
40.005.....	102	40.409.....	102	AGT4.....	84	CA512/2-3.....	61
40.006.....	102	40.410.....	102	AGT4/3.....	85	CA512/2-4.....	61
40.007.....	102	40.411.....	102	AGT4/4.....	85	CA512/3-2.....	61
40.008.....	102	40.412.....	102	AGT6.....	84	CA512/3-3.....	61
40.009.....	102	40.502.....	103	AGT6/3.....	85	CA512/3-4.....	61
40.010.....	102	40.503.....	103	AS2.5.....	80	CA512/4-2.....	61
40.011.....	102	40.504.....	103	AS2.5/3.....	81	CA512/4-3.....	61
40.012.....	102	40.505.....	103	AS2.5/4.....	81	CA512/4-4.....	61
40.102.....	103	40.506.....	103	AS4.....	80	CA512/7-2.....	61
40.103.....	103	40.507.....	103	AS4/3.....	81	CA512/7-3.....	61
40.104.....	103	40.508.....	103	AS4/4.....	81	CA512/7-4.....	61
40.105.....	103	40.509.....	103	AS6.....	80	CA512/8-2.....	61
40.106.....	103	40.510.....	103	AS6/3.....	82	CA512/8-3.....	61
40.107.....	103	40.511.....	103	ATL2.5.....	83	CA512/8-4.....	61
40.108.....	103	40.512.....	103	ATL2.5H.....	83	CA514/1-2.....	61
40.109.....	103	40.702.....	103	ATLG2.5.....	83	CA514/1-3.....	61
40.110.....	103	40.703.....	103	AUX6.....	8	CA514/13-2.....	61
40.111.....	103	40.704.....	103	BS1016E.....	105	CA514/13-3.....	61
40.112.....	103	40.705.....	103	BS1016EM1-12.....	105	CA514/13-4.....	61
40.202.....	102	40.706.....	103	BS1016EM13-24.....	105	CA514/1-4.....	61
40.203.....	102	40.707.....	103	BS24E.....	105	CA514/14/4A.....	61
40.204.....	102	40.708.....	103	BS24EM1-12.....	105	CA514/14-2.....	61
40.205.....	102	40.709.....	103	BS24EM13-24.....	105	CA514/14-3.....	61
40.206.....	102	40.710.....	103	BS60E.....	105	CA514/14-3A.....	61
40.207.....	102	40.711.....	103	BS60EM1-12.....	105	CA514/14-4.....	61
40.208.....	102	40.712.....	103	BS60EM13-24.....	105	CA514/15-2.....	61
40.209.....	102	2511110.....	106	CA102.....	49, 109	CA514/15-3.....	61
40.210.....	102	2511111.....	106	CA103.....	87, 109	CA514/15-4.....	61
40.211.....	102	2511115.....	106	CA202.....	49, 61, 109	CA514/17-2.....	61
40.212.....	102	2511120.....	106	CA302.....	109	CA514/17-3.....	61
40.302.....	103	2511121.....	106	CA402.....	109	CA514/17-4.....	61
40.303.....	103	2511125.....	106	CA502.....	109	CA514/2-2.....	61
40.304.....	103	2511150.....	107	CA512/1-2.....	61	CA514/2-3.....	61
40.305.....	103	2511160.....	107	CA512/1-3.....	61	CA514/2-4.....	61
40.306.....	103	2511110/1M.....	106	CA512/13-2.....	61	CA514/3-2.....	61
40.307.....	103	2511111/1M.....	106	CA512/13-3.....	61	CA514/3-3.....	61
40.308.....	103	2511115/1M.....	106	CA512/13-4.....	61	CA514/3-4.....	61
40.309.....	103	2511120/1M.....	106	CA512/1-4.....	61	CA514/4-2.....	61
40.310.....	103	2511121/1M.....	106	CA512/14-2.....	61	CA514/4-3.....	61
40.311.....	103	2511125/1M.....	106	CA512/14-3.....	61	CA514/4-4.....	61
40.312.....	103	2511150/1M.....	107	CA512/14-4.....	61	CA514/7-2.....	61
40.402.....	102	2511160/1M.....	107	CA512/15-2.....	61	CA514/7-3.....	61
40.403.....	102	ADL2.5(E)D1.....	82	CA512/15-3.....	61	CA514/7-4.....	61
40.404.....	102	ADL2.5(E)D2.....	82	CA512/15-4.....	61	CA514/8-2.....	61
40.405.....	102	ADLG2.5.....	82	CA512/17-2.....	61	CA514/8-3.....	61

Cat. No.	Page	Cat. No.	Page	Cat. No.	Page	Cat. No.	Page
CA514/8-4.....	61	CA704/3.....	48	CA718/2.....	48	CA741/100.....	48
CA601/S.....	107	CA704/4.....	48	CA718/3.....	48	CA741/2.....	48
CA602.....	109	CA704/6.....	48	CA718/4.....	48	CA741/3.....	48
CA603.....	108	CA704/8.....	48	CA721/10.....	48	CA741/4.....	48
CA607/S/Q.....	48	CA704/9.....	60	CA721/100.....	48	CA742/10.....	48
CA611/S/Q.....	48	CA705.....	108	CA721/2.....	48	CA742/100.....	48
CA623/10.....	48	CA705/01.....	48	CA721/3.....	48	CA742/2.....	48
CA623/2.....	48	CA705/1.....	48	CA721/4.....	48	CA742/3.....	48
CA623/3.....	48	CA705/10.....	48	CA722/10.....	48	CA742/4.....	48
CA623/4.....	48	CA705/11.....	60	CA722/100.....	48	CA743/10.....	48
CA624/10.....	48	CA705/2.....	48	CA722/2.....	48	CA743/2.....	48
CA624/2.....	48	CA705/3.....	48	CA722/3.....	48	CA743/3.....	48
CA624/3.....	48	CA705/4.....	48	CA722/4.....	48	CA743/4.....	48
CA624/4.....	48	CA705/6.....	48	CA723/10.....	48	CA744/10.....	48
CA625/10.....	48	CA705/8.....	48	CA723/2.....	48	CA744/2.....	48
CA625/2.....	48	CA705/9.....	60	CA723/3.....	48	CA744/3.....	48
CA625/3.....	48	CA707/S/Q/01.....	48	CA723/4.....	48	CA744/4.....	48
CA625/4.....	48	CA707/S/Q/1.....	48	CA724/10.....	48	CA745/10.....	48
CA627/10.....	48	CA707/S/Q/2.....	48	CA724/2.....	48	CA745/2.....	48
CA627/2.....	48	CA707/S/Q/3.....	48	CA724/3.....	48	CA745/3.....	48
CA627/3.....	48	CA707/TS/01.....	6	CA724/4.....	48	CA745/4.....	48
CA627/4.....	48	CA707/TS/05.....	6	CA725/10.....	48	CA747/10.....	48
CA628/2.....	8, 48	CA707/TS/06.....	7	CA725/2.....	48	CA747/100.....	48
CA628/3.....	8, 48	CA710/10.....	48	CA725/3.....	48	CA747/2.....	48
CA629/2.....	8, 48	CA710/2.....	48	CA725/4.....	48	CA747/3.....	48
CA629/3.....	8, 48	CA710/3.....	48	CA727/10.....	48	CA747/4.....	48
CA701-15.....	106	CA710/4.....	48	CA727/100.....	48	CA749/10.....	48
CA701-15/S.....	106	CA711/10.....	48	CA727/2.....	48	CA749/2.....	48
CA701-15/S-2M.....	106	CA711/2.....	48	CA727/3.....	48	CA749/3.....	48
CA701-15-2M.....	106	CA711/3.....	48	CA727/4.....	48	CA749/4.....	48
CA702.....	49, 61, 87, 109	CA711/4.....	48	CA728/10.....	61	CA751/10.....	48
CA703.....	108	CA714/10.....	48	CA728/2.....	61	CA751/2.....	48
CA703/01.....	48	CA714/2.....	48	CA728/3.....	61	CA751/3.....	48
CA703/1.....	48	CA714/3.....	48	CA728/4.....	61	CA751/4.....	48
CA703/10.....	48	CA714/4.....	48	CA729/10.....	48	CA761/10.....	48
CA703/11.....	60	CA715/10.....	48	CA729/2.....	48	CA761/2.....	48
CA703/2.....	48	CA715/2.....	48	CA729/3.....	48	CA761/3.....	48
CA703/3.....	48	CA715/3.....	48	CA729/4.....	48	CA761/4.....	48
CA703/4.....	48	CA715/4.....	48	CA731/10.....	48	CA770/10.....	48
CA703/6.....	48	CA716/10.....	48	CA731/100.....	48	CA771/10.....	48
CA703/8.....	48	CA716/2.....	48	CA732/10.....	48	CA771/2.....	48
CA703/9.....	60	CA716/3.....	48	CA732/100.....	48	CA771/3.....	48
CA704.....	108	CA716/4.....	48	CA733/10.....	48	CA771/4.....	48
CA704/01.....	48	CA717/10.....	48	CA734/10.....	48	CA772/10.....	61
CA704/1.....	48	CA717/2.....	48	CA735/10.....	48	CA772/2.....	61
CA704/10.....	48	CA717/3.....	48	CA737/10.....	48	CA772/3.....	61
CA704/11.....	60	CA717/4.....	48	CA739/10.....	48	CA772/4.....	61
CA704/2.....	48	CA718/10.....	48	CA741/10.....	48	CA774/2.....	61

Cat. No.	Page	Cat. No.	Page	Cat. No.	Page	Cat. No.	Page
CA774/3.....	61	CBB70LS.....	58	CDL4U(E)L1/6V.....	45	CDLG4.....	11
CA774/4.....	61	CBB95.....	58	CDL4U(E)L2/24V.....	45	CDLG4(I.S).....	11
CA781/10.....	48	CBB95LS.....	58	CDL4U(E)L2/6V.....	45	CDS6U.....	26
CA781/2.....	48	CBS3U.....	52	CDL4U(E)LA/1000V.....	46	CDS6U/FT.....	26
CA781/3.....	48	CBS4U.....	52	CDL4U(E)LA/230V.....	46	CDS6U/SC.....	41
CA781/4.....	48	CBS5U.....	52	CDL4U(E)LA/600V.....	46	CDS6U/TS.....	26
CA801/1.....	86	CCC4U.....	23	CDL4U(E)LA/75V.....	46	CDTTU.....	30
CA801/1-3.....	86	CDB10/2.....	33	CDL4U(E)LA/90V.....	46	CDTTUFT.....	30
CA801/2.....	86	CDB10/3.....	33	CDL4U(E)LD1/12V.....	45	CDTTUFTSC.....	41
CA801/2-3.....	86	CDB10/4.....	33	CDL4U(E)LD1/24V.....	45	CDTTUSC.....	41
CA801/3.....	86	CDB25/1.....	33	CDL4U(E)LD2/12V.....	45	CDTTU-SH.....	30
CA801/3-3.....	86	CDB25/2.....	33	CDL4U(E)LD2/24V.....	45	CENC16.....	36
CA802.....	49, 61, 87, 109	CDB25/3.....	33	CDL4U(E)LD3/12V.....	44	CENC35.....	36
CA803/1.....	92	CDB25/4.....	33	CDL4U(E)LD3/24V.....	44	CENC4.....	36
CA901/1.....	86	CDB4/1.....	33	CDL4U(E)LD4/24V.....	45	CF4PFT.....	19
CA901/2.....	86	CDB4/10(1).....	32	CDL4U(E)LD4/48V.....	45	CF4SP.....	19, 29
CA901/3.....	86	CDB4/11(1).....	32	CDL4U(E)LD5/110V.....	44	CF4SP(L)/110-240V.....	19
CA901/4.....	86	CDB4/2.....	33	CDL4U(E)LD5/220V.....	44	CF4SP(L)/6-60V.....	19
CA901/5.....	86	CDB4/2(1).....	32	CDL4U(E)LD5/24V.....	44	CF4SPFT.....	29
CA901/6.....	86	CDB4/3.....	33	CDL4U(E)LD5/48V.....	44	CF4U.....	18, 89
CA902.....	108	CDB4/3(1).....	32	CDL4U(E)MOV130V.....	47	CF4U(L)/110-240V.....	18
CAFL4U.....	22	CDB4/4.....	33	CDL4U(E)MOV275V.....	47	CF4U(L)/6-60V.....	18
CAFL4U(L)/110.....	22	CDB4/4(1).....	32	CDL4U(E)MOV30V.....	47	CGMT4.....	89
CAFL4U(L)/220.....	22	CDB4/5.....	33	CDL4U(E)MOV460V.....	47	CGT10N.....	17
CAFL4U(L)/24.....	22	CDB4/5(1).....	32	CDL4U(E)MOV510V.....	47	CGT16N.....	17
CAFL4U(L)/48.....	22	CDB4/6.....	33	CDL4U(E)MOV60V.....	47	CGT35U.....	17
CAFL4U(N).....	22	CDB4/6(1).....	32	CDL4U(E)MOV625V.....	47	CGT4N.....	16
CASP.....	108	CDB6/1.....	33	CDL4U(E)MOV680V.....	47	CGT4U.....	16
CB16/2H.....	94	CDB6/2.....	33	CDL4U(E)MOV75V.....	47	CGT6N.....	16
CB16/3H.....	94	CDB6/3.....	33	CDL4U(E)N1/110V.....	44	CHV10U.....	37
CB4/1.....	94	CDB6/4.....	33	CDL4U(E)N1/220V.....	44	CHV4U.....	37
CB4/2.....	94	CDL4U SPACER.....	108	CDL4U(E)RC0.1.....	46	CHV6U.....	37
CB4/2H.....	94	CDL4U(E)3LA/230V.....	46	CDL4U(E)RC0.22.....	46	CKT4SP.....	29
CB4/3.....	94	CDL4U(E)3LA/350V.....	46	CDL4U(E)SDB12VDC.....	47	CKT4SPSC.....	41
CB4/3H.....	94	CDL4U(E)3LA/600V.....	46	CDL4U(E)SDB160VDC.....	47	CKT4U.....	28
CB6/1.....	94	CDL4U(E)3LA/90V.....	46	CDL4U(E)SDB24VDC.....	47	CKT4U/4.....	28
CB6/2H.....	94	CDL4U(E)D1.....	42	CDL4U(E)SDB48VDC.....	47	CM1.5S.....	93
CB6/3H.....	94	CDL4U(E)D2.....	42	CDL4U(E)SDUA12VDC.....	47	CM1.5S2.....	93
CB6/4H.....	94	CDL4U(E)D3.....	42	CDL4U(E)SDUA24VDC.....	47	CM2.5S.....	93
CBB120.....	59	CDL4U(E)D4/12V.....	43	CDL4U(E)SDUA48VDC.....	47	CM2.5S2.....	93
CBB120LS.....	59	CDL4U(E)D4/24V.....	43	CDL4U(E)SDUK12VDC.....	47	CM4S.....	93
CBB150.....	59	CDL4U(E)DD1.....	42	CDL4U(E)SDUK24VDC.....	47	CM4S2.....	93
CBB150LS.....	59	CDL4U(E)DD2.....	42	CDL4U(E)SDUK48VDC.....	47	CMB4.....	90
CBB185.....	59	CDL4U(E)DD3.....	43	CDL4U(O).....	45	CMC1-2.....	9
CBB185LS.....	59	CDL4U(E)DD4.....	43	CDL4UN.....	10	CMC2-2.....	9
CBB35/50.....	58	CDL4U(E)DD5/12V.....	43	CDL4UN(I.S).....	10	CMCG4.....	9
CBB35/50LS.....	58	CDL4U(E)DD5/24V.....	43	CDL4USP.....	42	CMDB10/10.....	34
CBB70.....	58	CDL4U(E)L1/24V.....	45	CDLG2.5.....	11	CMDB10/2.....	34

Cat. No.	Page	Cat. No.	Page	Cat. No.	Page	Cat. No.	Page
CMDB10/3	34	CTL2.5U-H.....	14	CXCC4.....	75	DDFL4U(E)/110	20
CMDB10/4	34	CTL2.5UH(I.S)D2.....	15	CXCP2.5/4	92	DDFL4U(E)/220	20
CMDB25/10	34	CTL2.5U-H(L)/110.....	15	CXDB35/10	35, 79	DDFL4U(E)/24	20
CMDB25/2	34	CTL2.5U-H(L)/12	15	CXDB35/10A	35, 79	DDFL4U(E)/440	20
CMDB25/3	34	CTL2.5U-H(L)/220	15	CXDIN.....	78	DDFL4U(E)/48	20
CMDB25/4	34	CTL2.5U-H(L)/24	15	CXDL2.5	71	DDFL4U(E)LR/110.....	21
CMDB4/10	34	CTL2.5U-H(L)/48	15	CXDL2.5(E)D1	72	DDFL4U(E)LR/220.....	21
CMDB4/2	34	CTLG2.5	15	CXDL2.5(E)D2	72	DDFL4U(E)LR/24.....	21
CMDB4/3	34	CTLG2.5(E)MOV130V	47	CXDL2.5(E)D3	72	DDFL4U(E)LR/440.....	21
CMDB4/4	34	CTLG2.5(E)MOV275V	47	CXDL2.5(E)DD1	73	DDFL4U(E)LR/48.....	21
CMDB6/10	34	CTLG2.5(E)MOV30V	47	CXDL2.5(E)DD2	73	DDFL4ULR	21
CMDB6/2	34	CTLG2.5(E)MOV60V	47	CXDL2.5(E)DD3	73	EP0DL2.5.....	49
CMDB6/3	34	CTLG2.5(E)MOV75V	47	CXDL2.5(E)DD4	73	EP0DL4U	49
CMDB6/4	34	CTS10U	7	CXDL2.5(E)LD1	73	EP10DL2.5.....	49
CMS2.5.....	91	CTS10USC	40	CXDL2.5(E)TS1	73	EP10DL4U	49
CMT4	89	CTS16U	7	CXDL2.5(I.S).....	71	EP2.5/4UN	49
CMTB35.....	108	CTS2.5U-N	6	CXDLG2.5.....	71	EP6/10U.....	49
CPD1	75	CTS25UN.....	7	CXDLG2.5(I.S).....	71	EPADL2.5	87
CPF.....	23, 75	CTS35UN.....	7	CXF4.....	74	EPADLG2.5.....	87
CPF(L)110-240V	75	CTS4U-N	6	CXF4(L)110-240V	74	EPAS2.5.....	87
CPF(L)6-60V.....	75	CTS4USC	40	CXF4(L)6-60V.....	74	EPAS4.....	87
CPFL110-240V	23	CTS50/70N	8	CXG10	69	EPAS6.....	87
CPFL6-60V	23	CTS50/70NA.....	8	CXG10/3	70	EPATL2.5	87
CSB3/N3U	53	CTS6U	6	CXG2.5	68	EPATL2.5H	87
CSB3/N3UL	53	CTS6USC	40	CXG2.5/3	69	EPATLG2.5	87
CSB4/N4U	53	CTS95/120N.....	8	CXG2.5/4	69	EPCAFL4U	49
CSB5/N5U	53	CTSPC.....	49	CXG4	68	EPCBS3U	61
CSC16T	65	CTT2.5UG.....	38	CXG4/3	69	EPCDL4U	49
CSCP2.5T.....	92	CTT2.5UJ.....	38	CXG4/4	70	EPCDL4UN.....	49
CSCP2.5T2.....	92	CTT2.5UK.....	38	CXG6	68	EPCDLG2.5	49
CSDL4U.....	31	CTT2.5UT	38	CXG6/3	70	EPCDS6U.....	49
CSP1.....	49	CX10	65	CXK2.5.....	76	EPCDTTU	49
CSTSB4U	55	CX10/3.....	66	CXK2.5/4.....	76	EPCKT4U	49
CSTSB5U	55	CX2.5.....	64	CXK4.....	76	EPCKT4U/4	49
CSTSN4U	54	CX2.5/1B.....	78	CXLPN.....	78	EPCM1.5S	93
CSTSN5U	54	CX2.5/3.....	65	CXM2.5	91	EPCM2.5S	93
CSTSN6U	54	CX2.5/4.....	65	CXMG2.5	91	EPCM4S	93
CSTSPC1-2	61	CX2.5/4(E)D1.....	67	CXPOL.....	78	EPCMB4	90
CSTSPC1-3	61	CX2.5/4P.....	67	CXS2.5.....	77	EPCMC1-2.....	49
CSTSPC1-4	61	CX2.5PLN.....	78	CXS4.....	77	EPCMC2-2.....	49
CTC4U.....	39	CX2.5PN	78	CXSG2.5.....	77	EPCMT4	49, 89
CTL2.5U.....	14	CX2.5SLN.....	78	CXSG4.....	77	EPCSCP2.5T	92
CTL2.5U(I.S).....	14	CX2.5SN	78	CXSR2N	78	EPCSFL4U	49
CTL2.5U(L)/110	15	CX4	64	CXSR4N	78	EPCSTSU	61
CTL2.5U(L)/12	15	CX4/3.....	66	D35CLIP-M4	108	EPCTC4U	49
CTL2.5U(L)/220	15	CX4/4.....	66	D35CLIP-M5	108	EPCTL2.5U.....	49
CTL2.5U(L)/24	15	CX6.....	64	DDDL4U.....	31	EPCTL2.5U-H.....	49
CTL2.5U(L)/48	15	CX6/3.....	66	DDFL4U	20	EPCTLG2.5.....	49

Cat. No.	Page	Cat. No.	Page	Cat. No.	Page	Cat. No.	Page
EPCX10	87	HE10HWPR/02	99	HE1HWPR/06	98	HE42SST/10	101
EPCX10/3	87	HE10HWPR/03	99	HE1HWPR/07	98	HE42SST/11	101
EPCX2.5	87	HE10HWPR/04	99	HE1HWPR/08	98	HE42SST/12	101
EPCX2.5/3	87	HE10HWPR/05	99	HE1HWPR/09	98	HE42ST/02	100
EPCX2.5/4	87	HE10HWPR/06	99	HE1HWPR/10	98	HE42ST/03	100
EPCX4	87	HE10HWPR/07	99	HE1HWPR/11	98	HE42ST/04	100
EPCX4/3	87	HE10HWPR/08	99	HE1HWPR/12	98	HE42ST/05	100
EPCX4/4	87	HE10HWPR/09	99	HE1WPR/02	96	HE42ST/06	100
EPCX6	87	HE10HWPR/10	99	HE1WPR/03	96	HE42ST/07	100
EPCX6/3	87	HE10HWPR/11	99	HE1WPR/04	96	HE42ST/08	100
EPCXDL2.5	87	HE10HWPR/12	99	HE1WPR/05	96	HE42ST/09	100
EPCXM2.5	91	HE10WPR/02	97	HE1WPR/06	96	HE42ST/10	100
EPCXS2.5	87	HE10WPR/03	97	HE1WPR/07	96	HE42ST/11	100
EPCXS4	87	HE10WPR/04	97	HE1WPR/08	96	HE42ST/12	100
EPDDL4U	49	HE10WPR/05	97	HE1WPR/09	96	HE4HNWPR/02	98
EPSTH3	61	HE10WPR/06	97	HE1WPR/10	96	HE4HNWPR/03	98
EPSTH4	61	HE10WPR/07	97	HE1WPR/11	96	HE4HNWPR/04	98
EPSTH4DT	61	HE10WPR/08	97	HE1WPR/12	96	HE4HNWPR/05	98
EPSTH6	61	HE10WPR/09	97	HE42BU/02	100	HE4HNWPR/06	98
EPUSC	49	HE10WPR/10	97	HE42BU/03	100	HE4HNWPR/07	98
GMH1	110	HE10WPR/11	97	HE42BU/04	100	HE4HNWPR/08	98
GMH2	110	HE10WPR/12	97	HE42BU/05	100	HE4HNWPR/09	98
GMH3	110	HE16HWPR/02	99	HE42BU/06	100	HE4HNWPR/10	98
GMH4	110	HE16HWPR/03	99	HE42BU/07	100	HE4HNWPR/11	98
GMH5	110	HE16HWPR/04	99	HE42BU/08	100	HE4HNWPR/12	98
GMH6	110	HE16HWPR/05	99	HE42BU/09	100	HE4WPR/02	96
GMH7	110	HE16HWPR/06	99	HE42BU/10	100	HE4WPR/03	96
GMH8	110	HE16HWPR/07	99	HE42BU/11	100	HE4WPR/04	96
GMH8N	110	HE16HWPR/08	99	HE42BU/12	100	HE4WPR/05	96
GT10U	17	HE16HWPR/09	99	HE42SBU/02	101	HE4WPR/06	96
H4	105	HE16HWPR/10	99	HE42SBU/03	101	HE4WPR/07	96
H6	105	HE16HWPR/11	99	HE42SBU/04	101	HE4WPR/08	96
HCL10-12	104	HE16HWPR/12	99	HE42SBU/05	101	HE4WPR/09	96
HCL10-2	104	HE16WPR/02	97	HE42SBU/06	101	HE4WPR/10	96
HCL10-3	104	HE16WPR/03	97	HE42SBU/07	101	HE4WPR/11	96
HCL10-4	104	HE16WPR/04	97	HE42SBU/08	101	HE4WPR/12	96
HCL12-12	104	HE16WPR/05	97	HE42SBU/09	101	HE6HWPR/02	99
HCL12-2	104	HE16WPR/06	97	HE42SBU/10	101	HE6HWPR/03	99
HCL12-3	104	HE16WPR/07	97	HE42SBU/11	101	HE6HWPR/04	99
HCL12-4	104	HE16WPR/08	97	HE42SBU/12	101	HE6HWPR/05	99
HCL15-12	104	HE16WPR/09	97	HE42SST/02	101	HE6HWPR/06	99
HCL15-2	104	HE16WPR/10	97	HE42SST/03	101	HE6HWPR/07	99
HCL15-3	104	HE16WPR/11	97	HE42SST/04	101	HE6HWPR/08	99
HCL15-4	104	HE16WPR/12	97	HE42SST/05	101	HE6HWPR/09	99
HCL8-12	104	HE1HWPR/02	98	HE42SST/06	101	HE6HWPR/10	99
HCL8-2	104	HE1HWPR/03	98	HE42SST/07	101	HE6HWPR/11	99
HCL8-3	104	HE1HWPR/04	98	HE42SST/08	101	HE6HWPR/12	99
HCL8-4	104	HE1HWPR/05	98	HE42SST/09	101	HE6WPR/02	97

Cat. No.	Page	Cat. No.	Page	Cat. No.	Page
HE6WPR/03.....	97	MT6	111	TM5	110
HE6WPR/04.....	97	MT6F	111	TPSLS.....	26
HE6WPR/05.....	97	MT8	111	TX2.5	87
HE6WPR/06.....	97	MT9	111	TX4	87
HE6WPR/07.....	97	MT9F	111	TX6	87
HE6WPR/08.....	97	MTG1	110	WLX10	108
HE6WPR/09.....	97	MTG2	110	WLX2.5	108
HE6WPR/10.....	97	NEB10.....	36	WLX4	108
HE6WPR/11.....	97	NEB6.....	36	WLX6	108
HE6WPR/12.....	97	NES.....	36		
HEP4/16H.....	104	ODL2.5.....	13		
JX10/2.....	86	ODL2.5(I.S).....	13		
JX2.5/10.....	86	ODL4U	12		
JX2.5/2.....	86	ODLG2.5.....	13		
JX2.5/3.....	86	ODLG2.5(I.S).....	13		
JX2.5/4.....	86	PP2.5/4UN	49		
JX2.5/5.....	86	PP25UN	49		
JX2.5/6.....	86	PP35UN	49		
JX2.5/7.....	86	PP6/10U.....	49		
JX2.5/8.....	86	PPCMT4	49, 89		
JX4/10.....	86	PPCX4	87		
JX4/16.....	86	PPCX4.3	87		
JX4/2.....	86	PPCX4/4	87		
JX4/3.....	86	PPCX6	87		
JX4/4.....	86	PSPTB35	60		
JX4/8.....	86	PSPTB70	60		
JX6/10.....	86	PTB35/50	60		
JX6/2.....	86	PTB35/50SH.....	60		
JX6/3.....	86	PTB70/95	60		
JX6/4.....	86	PTB70/95SH.....	60		
JXS10/2.5	86	Q11/2	57		
JXS10/4	86	QJ8/2	26		
JXS6/2.5	86	SLS2	26		
JXS6/4	86	SLS3	26		
LCCDS.....	26	SLS4	26		
LCSTH4DT	57	SP2.5/4UN	49		
MH2.5	6	SP6/10U.....	49		
MH4	6	SPCDL4U	49		
MHPTB35	60	SPCDLG2.5	49		
MT10	111	SPCMB4	49		
MT12	111	STH3.....	56		
MT16	111	STH4.....	56		
MT2	111	STH4DT	57		
MT2B4.....	111	STH4DTFT.....	57		
MT2G	111	STH4DTSH.....	57		
MT3	111	STH6.....	56		
MT4	111	SWL10	108		
MT5	111	SWL4	108		

STANDARD TERMS AND CONDITIONS OF SALE

TITLE - Title to the products of ALTECH shall remain with ALTECH until payment is made in full by Customer. Such reservation of title is for the purpose of securing the purchase price and shall not relieve Customer of the duty to inspect the products upon receipt, to notify ALTECH of any deficiencies or defects, and to exercise due care in the use, installation, operation, and maintenance of the products when on the premise of the Customer or under the control of the Customer. Notwithstanding any reservation of title by ALTECH, risk of loss shall pass to customer at any time of shipment.

SHIPMENT AND DELIVERY - All orders for destination in the mainland United States (less Hawaii, Alaska and non-continental United States possessions) will be shipped F.O.B. Flemington, N.J. All destination, shipping and other charges shall be paid by the Customer in accordance with ALTECH's then current shipping and billing practices.

Delivery dates given in the acceptance of any order are approximate. ALTECH shall not be liable for delays in delivery or in performance due to causes beyond its reasonable control including acts of God, acts of Customer, acts of civil or military authority, fires, strikes or other labor disturbances, war, riot or delays in transportation. In the event of such delay, the date of delivery or performance shall be extended for a period equal to the time lost by reason of the delay.

PRICE - PRICES in any ALTECH publication are subject to change without prior notification. Catalog prices are based on prices published in the current price list. All written quotations are valid for thirty (30) days from the date of quotation. Customer shall pay all sales, use, excise or similar taxes whenever ALTECH must itself pay and/or collect such tax from Customer arising out of the sale.

PAYMENT - Customer agrees to make payment within thirty (30) days of date of the invoice from ALTECH. Customer agrees to pay a late payment charge of one and one-half percent (1.5% per month, or the maximum late payment charge permitted by applicable law, whichever is less, on any unpaid amount for each calendar month (or fraction thereof) that such payment is in default. Orders amounting to less than \$100.00 will be billed at \$100.00 plus freight. Full carton purchases are required. In the event of referral to an attorney for collection, reasonable attorney's fees for collection of the overdue amount shall be paid by Customer. In the event payment is not received within 30 days from the date of invoice, any discount shall be cancelled and the full list price will be due.

LIMITED WARRANTY - ALTECH warrants to Customer that the equipment purchases shall be free from defects in material and workmanship under normal use and service for a period of one year from shipment.

Written notice as an explanation of the circumstances of any claim that the equipment has proved defective in material or workmanship shall be given promptly by the Customer to ALTECH.

ALTECH will not be liable for any misuse, improper operations, improper installation, improper maintenance, alteration, modification, accident or unusual degradation of the equipment or parts due to an unsuitable installation environment.

No representation of other affirmation of facts, including but not limited to statements regarding capacity, suitability for use or performance of the equipment, shall be or be deemed to be a warranty or representation by ALTECH for any purpose, nor give rise to any liability or obligation of ALTECH whatsoever.

Customer's sole and exclusive remedy in the event of breach of warranty, as set forth herein, is expressly limited to (1) the correction of the defect by adjustment, repair, modification, or replacement, or (2) issuance of a credit or refund of the purchase price for the defective equipment at ALTECH's election and sole expense.

EXCEPT AS SPECIFICALLY PROVIDED IN THIS AGREEMENT, THERE ARE NO OTHER WARRANTIES EXPRESSED OR IMPLIED INCLUDING BUT NOT LIMITED TO ANY IMPLIED WARRANTIES OR MERCHANTABILITY OR FITNESS FOR A PARTICULAR PURPOSE.

THIS WARRANTY EXTENDS ONLY TO THE CUSTOMER FROM ALTECH OR ITS AUTHORIZED DISTRIBUTOR.

LIMITATION OF LIABILITY - IN NO EVENT, SHALL ALTECH BE LIABLE FOR LOSS OF PROFITS, INDIRECT, SPECIAL, CONSEQUENTIAL OR OTHER SIMILAR DAMAGES ARISING OUT OF ANY BREACH OF THIS AGREEMENT OR OBLIGATIONS UNDER THE AGREEMENT.

ALTECH SHALL NOT BE LIABLE FOR ANY DAMAGES CAUSED BY DELAY IN SHIPMENT, INSTALLATION OR FURNISHING OF EQUIPMENT OR SERVICES UNDER THIS AGREEMENT.

No action arising out of any claimed breach of this Agreement may be brought by either party more than two (2) years after the cause of action has accrued.

PATENT INDEMNITY - ALTECH shall defend or settle any suit or proceeding brought against Customer based on a claim that any equipment made to ALTECH design and furnished hereunder constitutes an infringement of any existing United States patent, provided (ALTECH) is notified promptly in writing and is given complete authorization and information required for the defense, and ALTECH shall pay all damages and costs awarded against Customer, but shall not be responsible for any costs, expense or compromise incurred or made by Customer without ALTECH's prior written consent. If any equipment is in ALTECH's opinion likely to or does become the subject of a claim for patent infringement, ALTECH may at its option and expense procure for Customer the right to continue using the device, modify it to become non-infringing, but in the event ALTECH is not reasonably able to modify, substitute, or otherwise procure for Customer the right to continue using it, ALTECH will remove such equipment and refund to Customer the amount paid in excess of a reasonable rental for past use.

ALTECH shall not be liable for any infringement or claim based upon use of the equipment in combination with other equipment not supplied by ALTECH or with modifications made by Customer.

The foregoing states the entire liability of ALTECH to Customer arising from patent infringement.

SELLER'S REMEDIES - Should Customer fail to make any payment within ten (10) days of its due date, or fail to perform any other of the Customer's obligation hereunder upon thirty (30) days written notice, or should Customer be or become insolvent or be a party to any bankruptcy receivership proceeding prior to full payment of all amounts payable hereunder, ALTECH may: (a) with or without demand or notice to customer declare the entire amount unpaid immediately due and payable; (b) enter upon the premises where the equipment may be found and remove it (Customer shall assemble the equipment and make it available to ALTECH at a place reasonably convenient to both parties and shall permit and assist ALTECH in effecting the retaking and removal of the equipment); and (c) sell any or all the equipment as permitted under applicable law, applying the proceeds of the sale to payment of the expenses of retaking, repairing and selling the equipment, reasonable attorney fees and to the satisfaction of all indebtedness then due and unpaid under this Agreement. Any surplus shall be paid to Customer and any deficiency shall be paid to ALTECH by Customer.

The remedies provided herein shall be cumulative and in addition to all other remedies provided by law or equity or under the Uniform Commercial Code.

GOVERNING LAW - This agreement will be governed by the Laws of the State of New Jersey.

GENERAL - This Agreement shall only become effective and binding when either (a) it has been accepted and executed by an authorized representative of ALTECH, or (b) the equipment has been shipped to Customer, with or without acceptance in writing hereon. Notice of acceptance is hereby waived by Customer. Customer hereby acknowledges receipt of a true and complete copy hereof.

No addition to or modification of any of the Terms and Conditions of Sale as they appear herein shall be binding upon ALTECH unless signed in writing by duly authorized representative of ALTECH in Flemington, N.J.

Typographical and clerical errors in quotations, orders and acknowledgments are subject to correction.

This Agreement is not assignable without the prior written consent of ALTECH. Any attempt to assign any of the rights, duties or obligations of this Agreement without such consent is void.

If any provision or provisions of this Agreement shall be held to be invalid, illegal or unenforceable, the validity, legality and enforceability, of the remaining provisions shall not in any way be affected or impaired thereby.

ALTECH is not responsible for failure to fulfill its obligation under this Agreement due to causes beyond its control, or except as agreed herein.

THE CUSTOMER ACKNOWLEDGES THAT HE HAS READ THE AGREEMENT, UNDERSTANDS IT, AND AGREES TO BE BOUND BY ITS TERMS AND CONDITIONS. FURTHERMORE, THE CUSTOMER AGREES THAT IT IS THE COMPLETE AND EXCLUSIVE STATEMENT OF THE AGREEMENT BETWEEN THE PARTIES, WHICH SUPERSEDES ALL PROPOSALS OR PRIOR AGREEMENTS, ORAL OR WRITTEN, EXPRESSED OR IMPLIED, AND ALL OTHER COMMUNICATIONS BETWEEN THE PARTIES RELATING TO THE SUBJECT MATTER OF THIS AGREEMENT.

ALTECH OFFERS A LARGE SELECTION OF AUTOMATION AND CONTROL COMPONENTS

Circuit Protection Devices



Altech the market leader in UL508 Manual Motor Controllers/ Miniature Circuit Breakers now introduces UL489 Miniature Circuit Breakers and UL1077 Supplementary Protectors. The UL489 versions are DIN rail mounted, 17.5mm wide, thermal magnetic, 240V, 480Y/277V AC, 50/60Hz, 125 and 250 VDC models, with short circuit interrupt capacity of 10kA, a positive trip indicator, and are line/load reversible. The UL1077 versions are DIN rail mounted, 17.5mm wide, thermal magnetic, 480Y/277V AC, 50/60Hz, a short circuit withstand capacity 10kA, have a positive trip indicator.

Altech Corp.®
35 Royal Rd., Flemington, NJ 08822
908-806-9400
FAX 908-806-9490
www.altechcorp.com

Industrial Enclosures



Altech offers a broad selection of non-metallic and aluminum Industrial Enclosures to meet your diverse design requirements. Sizes range from 1.97 x 2.05 x 1.38 to 35.43 x 11.81 x 5.59 inches. Materials include polycarbonate, polystyrene, polypropylene, ABS or aluminum. Polycarbonate and aluminum series have been recently expanded. Protection up to IP67 (NEMA 4, 4X). Smooth sidewalls or sidewalls with knockouts. Enclosures can be mounted directly onto a panel, frame or other mounting surfaces. EMI / RFI Coating is available. Competitive cover printing is available. Hinge Kits. Customization available.

Altech Corp.®
35 Royal Rd., Flemington, NJ 08822
908-806-9400
FAX 908-806-9490
www.altechcorp.com

Smart Relays



Supports up to 48 I/Os (32 digital inputs & 16 digital outputs). DST Feature Available. Backlit LCD Screen for display & modification of pre-selected parameters of functional blocks, viewing I/O status and programming on the device. PC software for programming, online & offline simulation, documentation & printing. Designed for use in automation for commercial & Industrial sectors. Modbus Communication. UL 508 (UL File No. E352868), IEC 61000-3-2 and IEC 61000-4-2-1-11. 250 lines of ladder programming. 16 soft text messages, Time Switches, Compare Counters, Timers, Counters & 12 analog functions.

Altech Corp.®
35 Royal Rd., Flemington, NJ 08822
908-806-9400
www.altechcorp.com

PCB Spring Clamp & Push-In Terminal Blocks



New spring clamp printed circuit board terminal blocks with push-in technology. Fixed push-in PCB terminals, PCB power terminals push-in, tension spring terminals and push-in plugs.

Altech Corp.®
35 Royal Rd., Flemington, NJ 08822
908-806-9400
www.altechcorp.com

Motor Disconnect Switches



Altech's line of Motor Disconnect Switches are UL 508 listed as Manual Motor Controllers for AC Motor Starting Across-the-line and AC General use. This new 16 page catalog includes the 3 different handle designs, which are all available in gray/black or yellow/red housings. Electrical ratings are 25-150A / 600V. The switches are non-fused DIN Rail mountable. Neat features include: snap-on auxiliary switches, door mounting kit and a retrofit 30A fuse holder. Also featured are Enclosed Motor Disconnect Switches & Fused Enclosed Motor Disconnect Switch (30A) in plastic or stainless housings.

Altech Corp.®
35 Royal Rd., Flemington, NJ 08822
908-806-9400
www.altechcorp.com

Power Supplies



Altech DIN RAIL mountable power supplies have Universal AC input. They are suitable for industrial and automation applications. UL508 Listed or UL Recognized. Single and Three phases up to 960W. Outputs of 5V, 12V, 15V, 24V and 48V. Class 2 devices are available. Installed on DIN rail TS35/ 7.5 or 15. Protections of Short circuit / Overload / Overvoltage / Over temperature. Cooling by free air convection. All-In-One DC-UPS, battery based. Ultra Capacitor DC-UPS, no battery required. World-wide approvals. 3 year warranty.

Altech Corp.®
35 Royal Rd., Flemington, NJ 08822
908-806-9400
www.altechcorp.com



- WEB TOOLS
 - Product Crossings
 - Request for Quote
 - Sample Request
 - Catalog Request
- PRODUCT MENU
 - Circuit Protection / Control >
 - Connectors >
 - Enclosures >
 - European Spare Parts >
 - Foot Switches
 - Interface Modules >
 - Power Supplies
 - Push Buttons & Pilot Lights >
 - Relays >
 - Sensors >
 - Terminal Blocks >
 - Tower Lights
 - Wire & Cable Management >
 - Home

New Products and Promotions

Serving the Automation & Control Industry Since 1984

Circuit Protection

 Circuit Protection Devices	 Busbar and Power Distribution	 Contactors, Overload Relays, Manual Motor Starters	 Motor Disconnect Switches	 European Fuses
--	---	--	---	--

Connectors

 Industrial Rectangular Connectors	 Pin & Sleeve Devices	 Receptacles	 Foot Switches	 Inductive Proximity Sensors
--	---	--	--	--

Enclosures

 Industrial Enclosures	 DIN Enclosures	 Interface Modules	 Safety Relays	 Slimline Relays
---	--	---	---	---

Modules & Relays

Power Supplies

 Power Supplies	 22 & 30 mm Push Buttons	 DIN Rail	 Liquid Tight Strain Reliefs/Corrugated Tubes	 Wire Duct
--	---	--	--	---

Terminal Blocks

 Din Rail Terminal Blocks	 Panel Mount Terminal Blocks	 Printed Circuit Board Terminal Blocks	 Eurostrips	 Distribution Blocks
--	---	---	--	---

Miscellaneous

 Ferrules	 Custom Assembly	 Marking & Engraving Systems	 Power Semi-conductors	 European Spare Parts
--	---	---	---	--

