

# Altech Corp.®

Serving the Automation & Control Industry since 1984



116

103

137



## DIN Rail Power Supplies



# DIN Rail Power Supplies

Since 1984, Altech Corporation has grown to become a leading supplier of automation and industrial control components. Headquartered in Flemington, NJ, Altech has an experienced staff of engineering, manufacturing and sales personnel to provide the highest quality products with superior service. This is the Altech Commitment!

In response to a growing market for high power regulated Power Supplies, Altech introduced the new Din Rail mountable power supply line. They are reliable, cost effective, space economical and easy to install and maintain. They are able to handle any industrial process requirement. In addition, you do not need to oversize them; they are designed to work on 100% load capacity. The universal input, power factor correction and many approvals proves that Altech Power Supplies will function worldwide on a wide variety of applications. Wide operation temperature range, high efficiency and many protections make Altech Power supplies your best choice.

Our well trained technical experts welcome the opportunity to answer your technical questions and provide solutions to your automation and control needs. Give us a call or visit [www.altechcorp.com](http://www.altechcorp.com).



## Quality Commitment

Altech's control components meet diverse national and international standards such as UL, NEC, CSA, IEC, VDE and more. Altech provides superior customer service and delivery through Total Quality Management and Continuous Process Improvement. Altech is ISO 9001 approved. We perform these services with honesty and integrity and are committed to achieve these goals.



## Selection Guide .....4-5



### NEW PSC Compact Class 2 Series

- Compact Design and Lightweight
  - Class 2, UL 1310 Recognized
  - Brown-out protection
  - 10W to 480W rated power
  - Universal single phase input
- .....6-35



### PS Industrial Series

- Robust Metal housing
  - UL 508 listed
  - Built in active PFC function
  - 75W to 960W rated power
  - Single and three phase universal input
- .....86-111



### NEW PSA Flex Series (1 Phase)

- Flex power , solid metal housing
  - UL 508 listed
  - 120W to 600W rated power
  - High efficiency with Boost Power
  - Single phase input
- .....36-47



### PS-C and W Series

- Narrow design, small metal housing
  - UL 508 listed
  - 150% pick load capacity
  - 120W to 480W rated power
  - Single and two phase wide input
- .....112-133



### NEW PSB Flex Series (2 & 3 Phase)

- Flex power , solid metal housing
  - UL 508 listed
  - 120W to 600W rated power
  - High efficiency with Boost Power
  - Two and Three phase input
- .....48-57



### NEW CBI DC UPS System

- Fully automated battery care module
  - Three charging modes
  - 12, 24, 36 and 48V DC single outputs
  - 110-230-277 / 230-400-500VAC input
  - System start from battery function
- .....134-155



### PS-S Slim line Series

- Slim Line Design, plastic housing
  - UL 508 listed
  - DC OK contact
  - 10W to 100W rated power
  - Universal single phase input
- .....58-71



### NEW CB Battery Chargers

- Intelligent battery chargers
  - Suitable for most common battery types
  - Adjustable charging current
  - 2 VDC and 24VDC single output
  - 110-220-277 VAC input
- .....155-189



### PS Low Profile Series

- Low profile Design, plastic housing
  - UL 60950-1 Recognized
  - Isolation Class II
  - 10W to 100W rated power
  - Universal single phase input
- .....72-85

### Accessories

- Redundancy diode module
  - UPS controller module
  - Battery holders and enclosures
  - Ultra capacitor modules
- .....190-199

FAQ .....200-203

Index .....204

Terms & Conditions.....206

# Selection Guide

Choose your product from a wide range of features and options, suitable for almost all applications.

	Cat. No.	Rated Current					Universal Input	Switch Select Input	Parallel Option	UL 508 Listed	UL 60950-1 Rec.	UL 1310 Rec.	EN 60950-1	NEC Class 2 Compliant	DC OK	Short Circuit	Overload	Over Voltage	Over Temperature	CB
		VDC	5	12	15	24														
<b>PSC Class 2 Compact</b>	<b>PSC-10xx</b>	-	0.84A	0.67A	0.42A	-														
	<b>PSC-20xx</b>	-	1.7A	1.4A	1A	-														
	<b>PSC-40xx</b>	-	3.4A	2.7A	1.7A	0.85A														
	<b>PSC-60xx</b>	-	4A	5A	2.5A	1.25A														
	<b>PSC-96xx</b>	-	7.5A	6.4A	4A	2A														
	<b>PSC-151xx</b>	-	-	-	6.3A	3.2A														
	<b>PSC-241xx</b>	-	-	-	10A	5A														
	<b>PSC-481xx</b>	-	-	-	20A	10A														
	<b>PSC-RM20</b>	-	-	-	20A	-														
<b>PSA &amp; PSB Flex</b>	<b>SINGLE PHASE</b>	<b>PSA-120xx</b>	-	-	-	5A	-													
		<b>PSA-180xx</b>	-	-	-	7.5A	-													
		<b>PSA-360xx</b>	-	-	-	14A	-													
		<b>PSA-600xx</b>	-	-	-	25A	-													
	<b>TWO (THREE) PHASE</b>	<b>PSB-120xx</b>	-	-	-	5A	-													
		<b>PSB-180xx</b>	-	-	-	7.5A	-													
		<b>PSB-360xx</b>	-	-	-	14A	-													
		<b>PSB-600xx</b>	-	-	-	25A	-													
<b>PS-S Slimline</b>	<b>SINGLE PHASE</b>	<b>PS-S10xx</b>	2A	0.84A	0.67A	0.42A	-													
		<b>PS-S20xx</b>	3A	1.67A	1.34A	1	-													
		<b>PS-S40xx</b>	6A	3.33A	-	1.7A	0.83A													
		<b>PS-S60xx</b>	10A	5A	-	2.5A	1.25A													
		<b>PS-S100xx</b>	-	7.5A	-	4A	2A													
<b>PS Low Profile</b>	<b>SINGLE PHASE</b>	<b>PS-15xx</b>	2.4A	1.25A	1A	0.63A	-													
		<b>PS-30xx</b>	3A	2A	2A	1.5A	-													
		<b>PS-45xx</b>	5A	3.5A	2.8A	2A	-													
		<b>PS-60xx</b>	6.5A	4.5A	4A	2.5A	-													
		<b>PS-100xx</b>	-	7.5A	6.5A	4.2A	-													

For the latest on Altech Power Supply specifications please visit [www.altechcorp.com/power](http://www.altechcorp.com/power).



# Selection Guide

Choose your product from a wide range of features and options, suitable for almost all applications.

	Cat. No.	Output Voltage					Universal Input	Switch Select Input	Parallel Input	UL 508 Listed	UL 60950-1 Rec.	UL 1310 Rec.	EN 60950-1	NEC Class 2 Compliant	DC OK	Short Circuit	Overload	Over Voltage	Over Temperature	CB
		VDC	5	12	15	24														
PS Industrial	SINGLE PHASE	PS-75xx	-	6.3A	-	3.2A	1.6A													
		PS-120xx	-	10A	-	5A	2.5A													
		PSH-120xx	-	-	-	5A	2.5A													
		PSP-240xx	-	-	-	10A	5A													
		PSP-480xx	-	-	-	20A	10A													
	PSP-480Sxx	-	-	-	20A	10A														
	THREE PHASE	PST-240xx	-	-	-	10A	5A													
		PST-480xx	-	-	-	20A	10A													
		PST-960xx	-	-	-	40A	20A													
		PST-960Pxx	-	-	-	40A	20A													
Compact Housing	SINGLE PHASE	PS-C120xx	-	10A	-	5A	2.5A													
		PS-C240xx	-	-	-	10A	5A													
		PSH-C480xx	-	-	-	20A	10A													
		PSP-C480Pxx	-	-	-	20A	10A													
	WIDE VOLTAGE	PSW-120xx	-	10A	-	5A	2.5A													
		PSW-240xx	-	-	-	10A	5A													
		PSW-480Pxx	-	-	-	20	10													
DC-UPS	CBI12xx	-	3-25A	-	-	-														
	CBI24xx	-	-	-	3-20A	-														
	CBI48xx	-	-	-	-	5-10A														
	CBI280 xx		12V/15A 24V/10A MULTI-VOLTAGE		36V/7A 48V/5A MULTI-VOLTAGE															
Battery Charger	CB12xx	-	3-35A	-	-	-														
	CB24xx	-	-	-	3-20A	-														
	CB12245A	-	6 A	-	5 A	-														
Acces.	PS-RDN				21-28V															
	PS-UPS				21-28V															

PSC Class 2 Series  
Compact Housing

PSA Flex Series  
1 Phase

PSB Flex Series  
2 & 3 Phase

PS-S Slim Series  
Plastic Housing

PS Low Profile Series  
Plastic Housing

PS Industrial Series  
1, 2 & 3 Phase

PS C & W Series  
1 and 2 Phase

CB Type  
Battery Chargers

CBI Type  
DC UPS Systems

Accessories

Appendix

- Three Phase Input
- 220V INPUT ONLY
- Wide Range Input
- Selected items, see data sheet
- Special order item / not UL approved.
- DC OK signal



## Compact Single Phase Power Supply (PSC)

ALTECH's Compact DIN rail switching power supply, PSC Series designed for the fast growing demand of DIN rail applications. These 10W to 480W models are enclosed with fully isolated plastic or metal case to prevent users from hazardous shock. The design complies with the compact requirements that the precious space on the industrial rail can be preserved effectively. Featuring up to 94% of efficiency, this series is cooled only by free air convection up to 70°C that significantly increase the reliability and lifetime of the power supply. Another important feature of PSC Series is its low power consumption (<0.75W) This unique characteristic can significantly expand the application of PSC series beyond just heavy industrial field, but can also be implied to dotcom or IT applications that require green power to save the energy and to obey the anticipated government laws in the near future!

Short circuit protection, overload protection, over voltage protection, and the DC OK signal for monitoring the status of power supply are standard functions for the PSC Series. Typical applications include factory automation, process control, electro-mechanical industry, dotcom and IT.

- Input voltage range: 85-264V AC; 120-370V DC
- AC inrush current (max): Cold start: 20A at 115V AC; 40A at 230V AC
- DC adjustment range:  $\pm 10\%$  rated output voltage
- Overload protection: 105% rated output power
- Over-voltage protection: 115%-150% rated output voltage
- Other protection: Brown out protection
- Setup, rise, time (max): 500ms, 30ms/230V AC  
1000ms, 30ms/115V AC, at full load
- Withstand voltage: I/P-O/P: 3KV AC, I/P-FG:1.5KV AC, O/P-FG:0.5KV AC
- Working temperature: -20 to +70°C (-4° to +158°F), refer to output de-rating curve
- Safety standards: UL508 listed, UL1310 recognized, TUV approved  
EN60950-1 compliant
- EMC standards: EN55022 class B  
EN61000-4-2,3,4,5,6,8,11  
ENV50204; EN55024; EN61000-6-1; EN61204-3;  
Light Industry Level criteria A
- Military Standard MIL-HDBK-217F
- Vibration withstands 2G test
- On/Off Built in remote ON/OFF function (metal case only)



# Compact Single Phase Power Supply (PSC)

## Features:

- Universal AC input/Full range
- Protections: Short circuit / Overload / Overvoltage
- Cooling by free air convection
- DIN rail mountable
- UL1310
- NEC class 2 / LPS compliant (12V,24V,48V only)
- No load power consumption <0.75W
- LED indicator for power on
- 100% full load burn-in test
- DC OK relay contact
- 3 year warranty

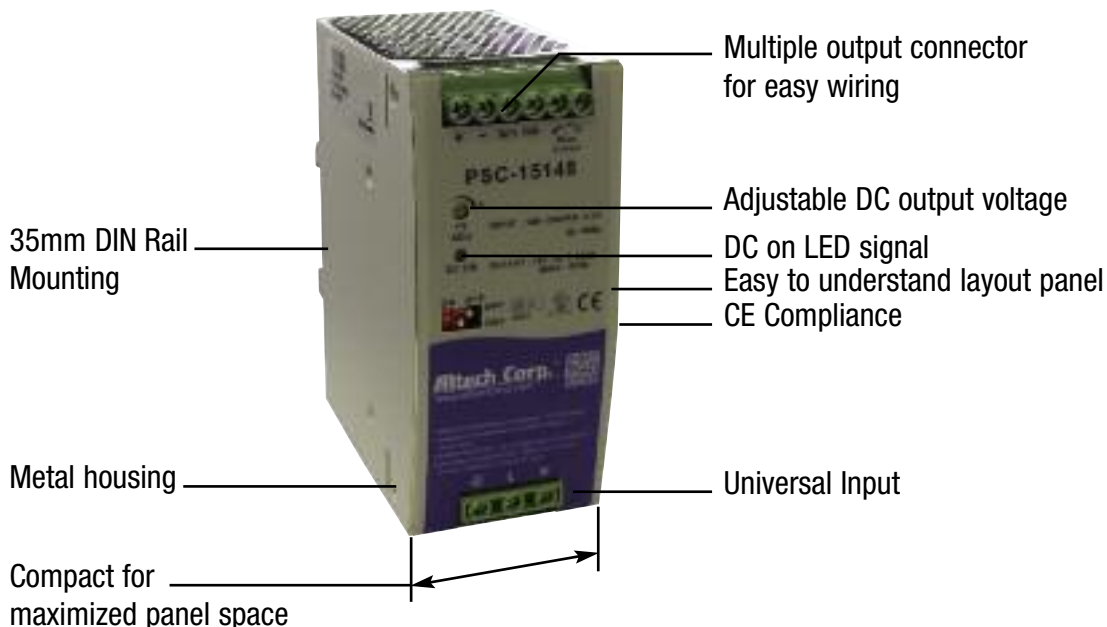

# Compact Single Phase Power Supply (PSC)



## 10W Single Output Industrial DIN Rail Power Supply

Cat. No.	Output		Tol. %	Ripple & Noise	Efficiency	NOTES
	V DC	A				
PSC-1012	12V DC	0.84A	±1%	100 mVp-p	81%	
PSC-1015	15V DC	0.67A	±1%	100 mVp-p	81%	
PSC-1024	24V DC	0.42A	±1%	120 mVp-p	81%	



## 20W Single Output Industrial DIN Rail Power Supply

Cat. No.	Output		Tol. %	Ripple & Noise	Efficiency	NOTES
	V DC	A				
PSC-2012	12V DC	1.7A	±1%	100 mVp-p	83%	
PSC-2015	15V DC	1.4A	±1%	100 mVp-p	85%	
PSC-2024	24V DC	1A	±1%	120 mVp-p	86%	



## 40W Single Output Industrial DIN Rail Power Supply

Cat. No.	Output		Tol. %	Ripple & Noise	Efficiency	NOTES
	V DC	A				
PSC-4012	12V DC	3.4A	±1%	100 mVp-p	84%	
PSC-4015	15V DC	2.7A	±1%	100 mVp-p	84%	
PSC-4024	24V DC	1.7A	±1%	120 mVp-p	84%	
PSC-4048	48V DC	0.85A	±1%	180 mVp-p	85%	



## 60W Single Output Industrial DIN Rail Power Supply

Cat. No.	Output		Tol. %	Ripple & Noise	Efficiency	NOTES
	V DC	A				
PSC-6012	12V DC	5A	±1%	100 mVp-p	86%	
PSC-6015	15V DC	4A	±1%	100 mVp-p	87%	
PSC-6024	24V DC	2.5A	±1%	120 mVp-p	87%	
PSC-6048	48V DC	1.25A	±1%	180 mVp-p	88%	



## 96W Single Output Industrial DIN Rail Power Supply

Cat. No.	Output		Tol. %	Ripple & Noise	Efficiency	NOTES
	V DC	A				
PSC-9612*	12V DC	7.5A	±1%	180 mVp-p	87%	
PSC-9615*	15V DC	6.4A	±1%	180 mVp-p	87%	
PSC-9624	24V DC	4A	±1%	180 mVp-p	88%	
PSC-9648	48V DC	2A	±1%	250 mVp-p	87%	

\*Not included in UL file E361915



# SPECIFICATIONS

## PSC-10 Series

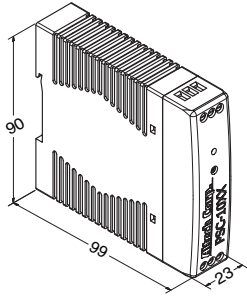

### Terminal Pin. No Assign. (TB1)

Pin No.	Assignment
1	FG ⊕
2	AC/N
3	AC/L

### Terminal Pin. No Assign. (TB2)

Pin No.	Assignment
4	DC OUTPUT +V
5	DC OUTPUT -V
6	DC OK SIGNAL

Universal Input: 88-264V AC, 124-370V DC full range;  
0.23A @ 110V AC; 0.17A @ 230V AC

Connection: Input - 2 poles, Output - 2 poles, single screw terminal  
Size (WxHxD): 23x90x99mm (0.9x3.54x3.94 inches)

Packaging: 1/box; 0.29lbs / 0.13Kg

## PSC-20 Series

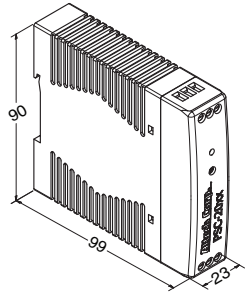

### Terminal Pin. No Assign. (TB1)

Pin No.	Assignment
1	FG ⊕
2	AC/N
3	AC/L

### Terminal Pin. No Assign. (TB2)

Pin No.	Assignment
4	DC OUTPUT +V
5	DC OUTPUT -V
6	DC OK SIGNAL

Universal Input: 88-264V AC, 124-370V DC full range;  
0.45A @ 110V AC; 0.32A @ 230V AC

Connection: Input - 2 poles, Output - 2 poles, single screw terminal  
Size (WxHxD): 23x90x99mm (0.9x3.54x3.94 inches)

Packaging: 1/box; 0.32lbs / 0.14Kg

## PSC-40 Series

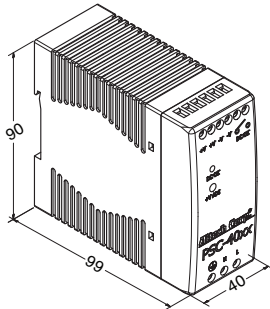

### Terminal Pin. No Assign. (TB1)

Pin No.	Assignment
1	FG ⊕
2	AC/N
3	AC/L

### Terminal Pin. No Assign. (TB2)

Pin No.	Assignment
1/2	DC OUTPUT +V
3/4	DC OUTPUT -V
5/6	DC OK Relay Contact

Universal Input: 88-264V AC, 124-370V DC full range;  
0.8A @ 115V AC, 0.4A @ 230V AC

Connection: Input - 2 poles, Output - 2 poles, double screw terminal  
Size (WxHxD): 40x90x99mm (1.57x3.54x3.94 inches)

Packaging: 1/box; 0.63lbs / 0.28Kg

## PSC-60 Series

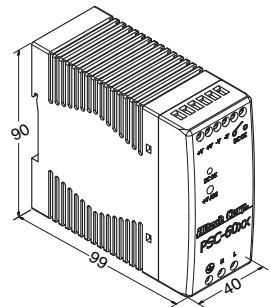

### Terminal Pin. No Assign. (TB1)

Pin No.	Assignment
1	FG ⊕
2	AC/N
3	AC/L

### Terminal Pin. No Assign. (TB2)

Pin No.	Assignment
1/2	DC OUTPUT +V
3/4	DC OUTPUT -V
5/6	DC OK Relay Contact

Universal Input: 88-264V AC, 124-370V DC full range;  
1.3A @ 115V AC, 0.6A @ 230V AC

Connection: Input - 2 poles, Output - 2 poles, double screw terminal  
Size (WxHxD): 40x90x99mm (1.57x3.54x3.94 inches)

Packaging: 1/box; 0.67lbs / 0.3Kg

## PSC-96 Series

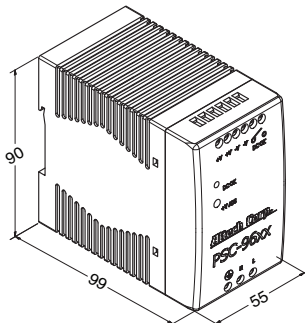

### Terminal Pin. No Assign. (TB1)

Pin No.	Assignment
1	FG ⊕
2	AC/N
3	AC/L

### Terminal Pin. No Assign. (TB2)

Pin No.	Assignment
1/2	DC OUTPUT +V
3/4	DC OUTPUT -V
5/6	DC OK Relay Contact

Universal Input: 88-264V AC, 124-370V DC full range;  
1.1A @ 115V AC, 0.55A @ 230V AC

Connection: Input - 2 poles, Output - 2 poles, double screw terminal  
Size (WxHxD): 55x90x99mm (2.17x3.54x3.94 inches)

Packaging: 1/box; 0.9lbs / 0.4Kg



# PSC-10 Series



## Features:

- Universal AC input (88-264V AC)
- Protections: Short Circuit / Overload / Overvoltage
- Brown-out protection
- Installed on DIN rail TS35 / 7.5 or 15
- True DC OK signal output
- All wiring 105°C long life electrolytic capacitors
- High operation temperature up to 70°C
- Withstands 2G vibration test
- High efficiency, long life and high reliability
- 3 year warranty
- UL1310 Class 2 Power unit / LPS pass
- UL508 (Industrial control equipment) listed

## OUTPUT

## INPUT

## PROTECTION

## ENVIRONMENT

## SAFETY & EMC

## OUTPUT

Cat. No.	PSC-1012	PSC-1015	PSC-1024
DC VOLTAGE	12V	15V	24V
RATED CURRENT	0.84A	0.67A	0.42A
CURRENT RANGE	0~0.84A	0~0.67A	0~0.42A
RATED POWER	10.08W	10.05W	10.08W
RIPPLE & NOISE (max)	100mVp-p	100mVp-p	120mVp-p
Ripple & noise are measured at 20MHz of bandwidth by using a 12" twisted pair-wire terminated with a 0.1µF & 47µF parallel capacitor			
VOLTAGE ADJ. RANGE	10.8~13.2V	13.5~16.5V	21.6~26.4V
VOLTAGE TOLERANCE	±1.0%	±1.0%	±1.0%
Tolerance: includes set up tolerance, line regulation and load regulation.			
LINE REGULATION	±1.0%	±1.0%	±1.0%
LOAD REGULATION	±1.0%	±1.0%	±1.0%
SETUP, RISE TIME	< 800ms, < 100ms/230V AC at full load		
HOLD UP TIME (Typ.)	> 32ms / 230V AC; > 16ms / 115V AC at full load		
VOLTAGE RANGE	88V~264VAC; 124V~370VDC Derating may be needed under low input voltages. Please check the derating curve for more details.		
FREQUENCY RANGE	47~63Hz		
EFFICIENCY (Typ.)	81%	81%	81%
AC CURRENT (Typ.)	0.23A/115VAC; 0.17A/230VAC		
INRUSH CURRENT (Typ.)	15A / 115V AC; 30A / 230V AC		
LEAKAGE CURRENT	< 1mA/ 230VAC		
OVERLOAD PROTECTION	> 102% rated output power Protection type: Constant current limiting, recovers automatically after fault condition is removed.		
OVERVOLTAGE PROTECTION	115%~150% rated output voltage Protection type: Latch-off mode.		
OVER TEMPERATURE PROTECTION	Power supply shut down at 70°C constant current limiting / output voltage goes to 0; re-power on to recover		
WORKING TEMP.	-20 ~ +70°C (Refer to output load derating curve)		
WORKING HUMIDITY	20 ~ 90% RH non-condensing		
STORAGE TEMP. / HUMIDITY	-40 ~ +85°C; 10 ~ 95% RH		
TEMP. COEFFICIENT	±0.03% / °C (0 ~ 50°C)		
VIBRATION	10 ~ 500Hz; 2G 10min. / 1cycle, 60 min. each long X,Y, Z axes		
SAFETY STANDARDS	UL508, TUV EN60950-1:2006+A11, UL1310 NEC class 2 compliant		
WITHSTAND VOLTAGE	I/P-O/P: 3KVAC (4242DC) I/P-FG: 1.5KVAC (2121DC) 1 minute		
ISOLATION RESISTANCE	I/P-O/P, I/P-FG, O/P-FG: 100M Ohms/500VDC		
EMI CONDUCTION & RADIATION	EN55022:2006+A1:2007 Class B		
HARMONIC CURRENT	EN61000-3-2:2006 Class A, EN61000-3-3:2008		
EMS IMMUNITY	EN61204-3:2000, EN55024:1998+A1:2001+A2:2003 light industry level, criteria A		
The power supply is considered a component which will installed into a final equipment. The final equipment must be re-confirmed that it still meets EMC directives.			
DC OK Signal	Open collector. Max: 40mA		
MTBF	562.7K hrs MIL-HDBK-217K		
DIMENSION	23x90x99 mm (WxHxD)		
PACKING	0.13Kg/48 pcs. / 7.44Kg		
CONNECTION	I/P 3 poles, O/P: 3 poles screw DIN terminal		
COOLING	Free air convection		
All parameters NOT specially mentioned are measured at 230V AC input, rated load and 25°C of ambient temperature.			



# PSC-10 Series

## Mechanical Specification

Unit : mm / inch

Terminal Pin. No Assign. (TB1)

Pin No.	Assignment
1	FG Ⓢ
2	AC/N
3	AC/L

Terminal Pin. No Assign. (TB2)

Pin No.	Assignment
4	DC OUTPUT +V
5	DC OUTPUT -V
6	DC OK SIGNAL

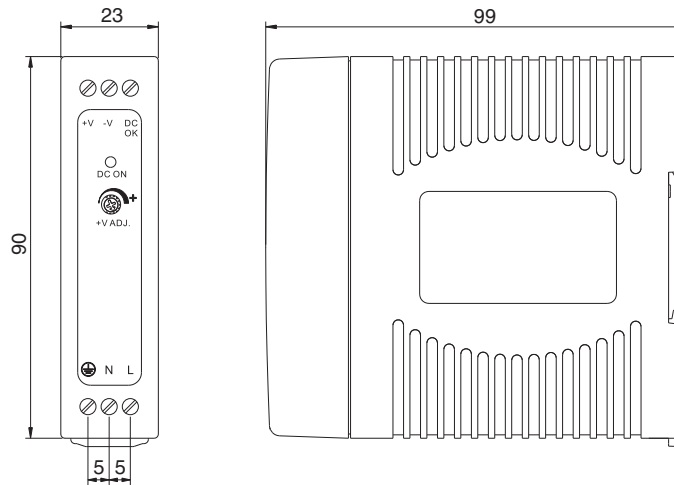

## Application of DC OK Active Signal

(a) 5V signal

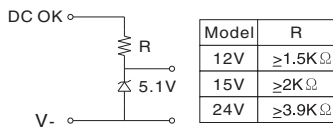

(b) LED

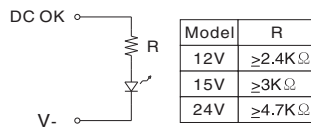

(c) Relay

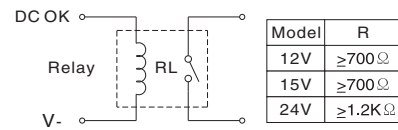

## Block Diagram

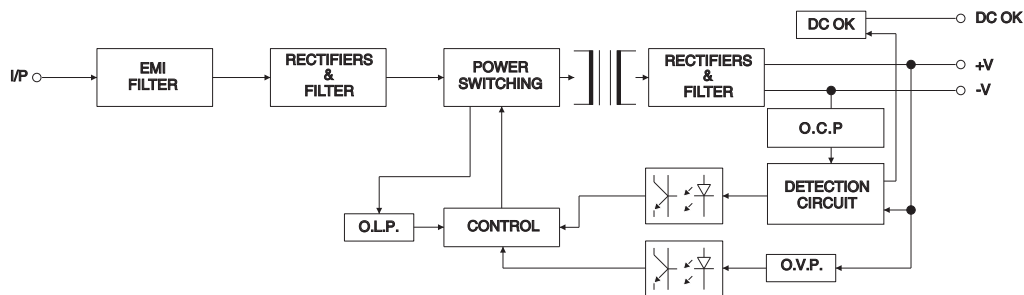

## Derating Curve

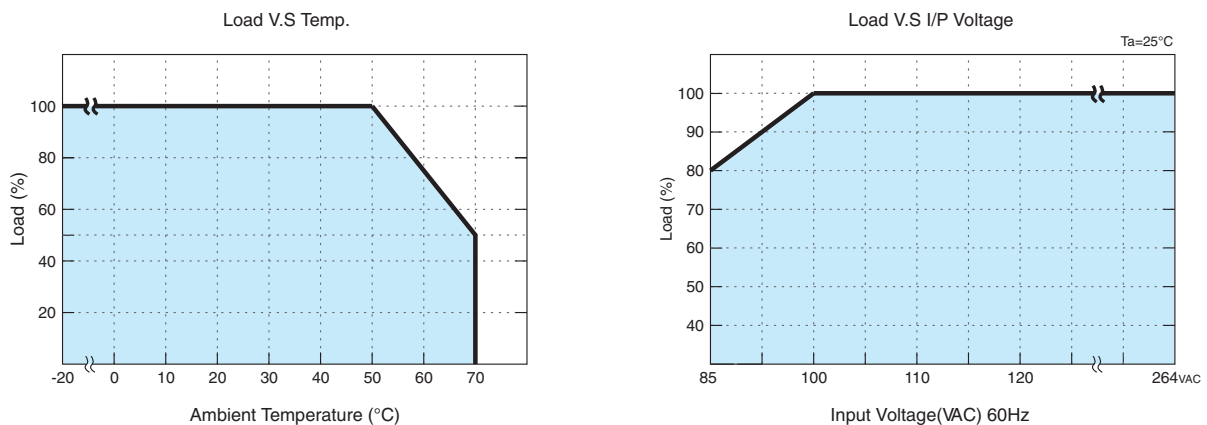

Note: All dimensions are in millimeters, to convert to inches multiply by 0.03937.



# PSC-20 Series



## Features:

- Universal AC input (88-264V AC)
- Protections: Short Circuit / Overload / Overvoltage
- Brown-out protection
- Installed on DIN rail TS35 / 7.5 or 15
- True DC OK signal output
- All wiring 105°C long life electrolytic capacitors
- High operation temperature up to 70°C
- Withstands 2G vibration test
- High efficiency, long life and high reliability
- 3 year warranty
- UL1310 Class 2 Power unit / LPS pass
- UL508 (Industrial control equipment) listed

## OUTPUT

## INPUT

## PROTECTION

## ENVIRONMENT

## SAFETY & EMC

## OUTPUT

Cat. No.	PSC-2012	PSC-2015	PSC-2024
DC VOLTAGE	12V	15V	24V
RATED CURRENT	1.7A	1.4A	1A
CURRENT RANGE	0~1.7A	0~1.4A	0~1A
RATED POWER	20.4W	21W	24W
RIPPLE & NOISE (max)	100mVp-p	100mVp-p	120mVp-p
Ripple & noise are measured at 20MHz of bandwidth by using a 12" twisted pair-wire terminated with a 0.1µF & 47µF parallel capacitor			
VOLTAGE ADJ. RANGE	10.8~13.2V	13.5~16.5V	21.6~26.4V
VOLTAGE TOLERANCE	±1.0%	±1.0%	±1.0%
Tolerance: includes set up tolerance, line regulation and load regulation.			
LINE REGULATION	±1.0%	±1.0%	±1.0%
LOAD REGULATION	±1.0%	±1.0%	±1.0%
SETUP, RISE TIME	< 800ms, < 100ms/230V AC at full load		
HOLD UP TIME (Typ.)	> 32ms / 230V AC; > 16ms / 115V AC at full load		
VOLTAGE RANGE	88V~264VAC; 124V~370VDC Derating may be needed under low input voltages. Please check the derating curve for more details.		
FREQUENCY RANGE	47~63Hz		
EFFICIENCY (Typ.)	83%	85%	86%
AC CURRENT (Typ.)	0.45A/115VAC; 0.32A/230VAC		
INRUSH CURRENT (Typ.)	20A / 115V AC; 40A / 230V AC		
LEAKAGE CURRENT	< 1mA/ 230VAC		
OVERLOAD PROTECTION	> 105% rated output power Protection type: Constant current limiting, recovers automatically after fault condition is removed.		
OVERVOLTAGE PROTECTION	115%~150% rated output voltage Protection type: Latch-off mode.		
OVER TEMPERATURE PROTECTION	Power supply shut down at 70°C constant current limiting / output voltage goes to 0; re-power on to recover		
WORKING TEMP.	-20 ~ +70°C (Refer to output load derating curve)		
WORKING HUMIDITY	20 ~ 90% RH non-condensing		
STORAGE TEMP. / HUMIDITY	-40 ~ +85°C; 10 ~ 95% RH		
TEMP. COEFFICIENT	±0.03% / °C (0 ~ 50°C)		
VIBRATION	10 ~ 500Hz, 2G 10min. / 1cycle, 60 min. each long X,Y, Z axes		
SAFETY STANDARDS	UL508, TUV EN60950-1:2006+A11, UL1310 NEC class 2 compliant		
WITHSTAND VOLTAGE	I/P-O/P: 4242DC I/P-FG: 2121DC 1 minute		
ISOLATION RESISTANCE	I/P-O/P, I/P-FG, O/P-FG: 100M Ohms/500VDC		
EMI CONDUCTION & RADIATION	EN55022:2006+A1:2007 Class B		
HARMONIC CURRENT	EN61000-3-2:2006 Class A, EN61000-3-3:2008		
EMS IMMUNITY	EN61204-3:2000, EN55024:1998+A1:2001+A2:2003 light industry level, criteria A		
The power supply is considered a component which will installed into a final equipment. The final equipment must be re-confirmed that it still meets EMC directives.			
DC OK Signal	Open collector. Max: 40mA		
MTBF	120.4K HRS MIL-HDBK-217 (25°C)	131.3K HRS MIL-HDBK-217 (25°C)	125.9K HRS MIL-HDBK-217 (25°C)
DIMENSION	23x90x99 mm (WxHxD)		
PACKING	0.14Kg/48 pcs./7.92Kg		
CONNECTION	I/P 3 poles, O/P: 3 poles screw DIN terminal		
COOLING	Free air convection		
All parameters NOT specially mentioned are measured at 230V AC input, rated load and 25°C of ambient temperature.			



# PSC-20 Series

## Mechanical Specification

Unit : mm / inch

Terminal Pin. No Assign. (TB1)

Pin No.	Assignment
1	FG Ⓢ
2	AC/N
3	AC/L

Terminal Pin. No Assign. (TB2)

Pin No.	Assignment
4	DC OUTPUT +V
5	DC OUTPUT -V
6	DC OK SIGNAL

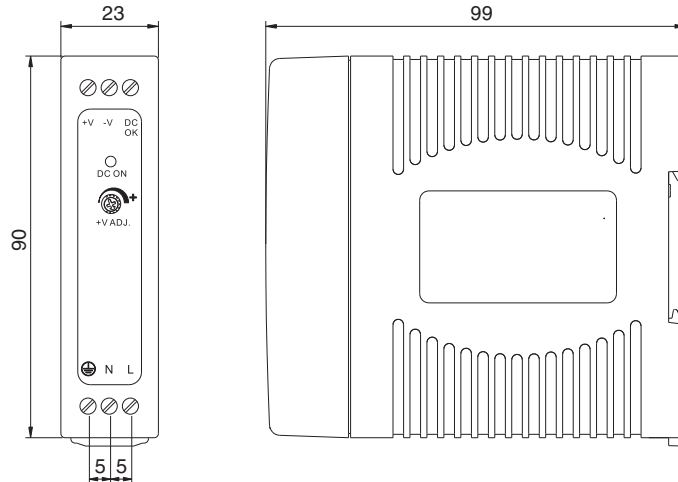

## Application of DC OK Active Signal

(a) 5V signal

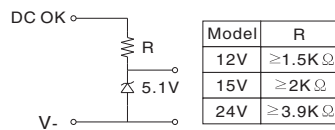

(b) LED

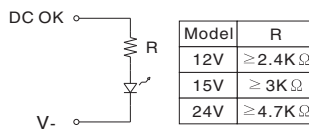

(c) Relay

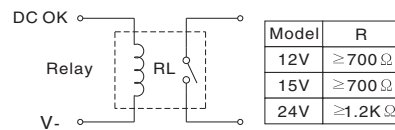

## Block Diagram

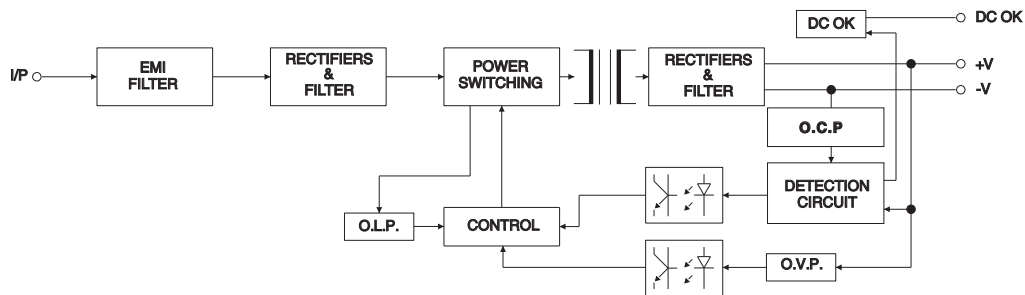

## Derating Curve

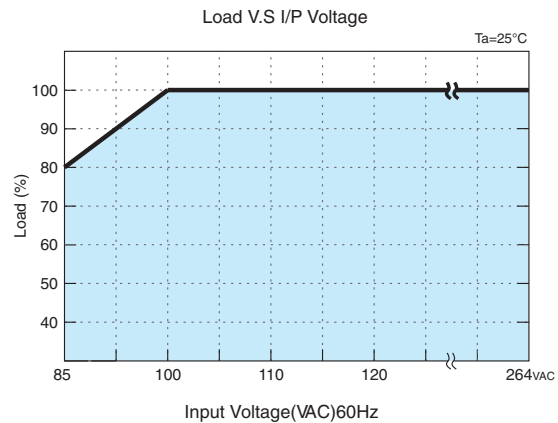
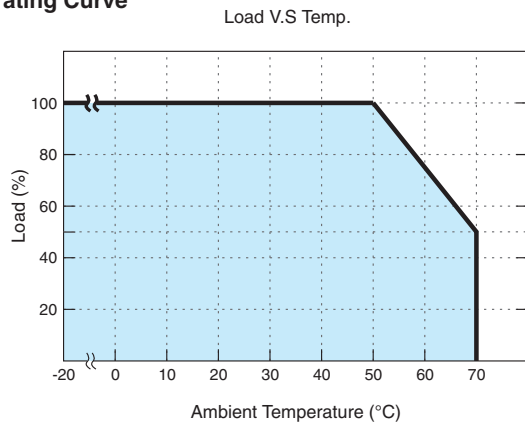

Note: All dimensions are in millimeters, to convert to inches multiply by 0.03937.



# PSC-40 Series



## Features:

- Universal AC input (88-264V AC)
- Protections: Short Circuit / Overload / Overvoltage
- Brown-out protection
- Installed on DIN rail TS35 / 7.5 or 15
- True DC OK signal output
- All wiring 105°C long life electrolytic capacitors
- High operation temperature up to 70°C
- Withstands 2G vibration test
- High efficiency, long life and high reliability
- 3 year warranty
- UL1310 Class 2 Power unit / LPS pass
- UL508 (Industrial control equipment) listed

## OUTPUT

## INPUT

## PROTECTION

## ENVIRONMENT

## SAFETY & EMC

## OUTPUT

Cat. No.	PSC-4012	PSC-4015	PSC-4024	PSC-4048
DC VOLTAGE	12V	15V	24V	48V
RATED CURRENT	3.4A	2.7A	1.7A	0.85A
CURRENT RANGE	0 ~ 3.4A	0 ~ 2.7A	0 ~ 1.7A	0 ~ 0.85A
RATED POWER	40.8W	40.5W	40.8W	40.8W
RIPPLE & NOISE (max)	100mVp-p	100mVp-p	120mVp-p	180mVp-p
Ripple & noise are measured at 20MHz of bandwidth by using a 12" twisted pair-wire terminated with a 0.1µF & 47µF parallel capacitor				
VOLTAGE ADJ. RANGE	10.8 ~ 13.2V	13.5 ~ 16.5V	21.6 ~ 26.4V	43.2 ~ 52.8V
VOLTAGE TOLERANCE	±1.0%	±1.0%	±1.0%	±1.0%
Tolerance: includes set up tolerance, line regulation and load regulation.				
LINE REGULATION	±1.0%	±1.0%	±1.0%	±1.0%
LOAD REGULATION	±1.0%	±1.0%	±1.0%	±1.0%
SETUP, RISE TIME	< 800ms, < 50ms / 230VAC at full load			
HOLD UP TIME (Typ.)	> 32ms / 230VAC; >16ms / 115VAC at full load			
VOLTAGE RANGE	88 ~ 264VAC; 124 ~ 370VDC			
Derating may be needed under low input voltages. Please check the derating curve for more details.				
FREQUENCY RANGE	47~63Hz	84%	84%	85%
EFFICIENCY (Typ.)	84%	84%	84%	85%
AC CURRENT (Typ.)	0.8 A / 115VAC; 0.4A / 230VAC			
INRUSH CURRENT (Typ.)	COLD START 30A / 115VAC; 60A / 230VAC			
LEAKAGE CURRENT	< 1mA/ 230VAC			
OVERLOAD PROTECTION	> 105% rated output power Protection type: Constant current limiting, recovers automatically after fault condition is removed.			
OVERVOLTAGE PROTECTION	115% ~ 150% rated output voltage Protection type: latch-off mode			
OVER TEMPERATURE PROTECTION	Power supply shut down at 70°C constant current limiting / output voltage goes to 0; re-power on to recover			
WORKING TEMP.	-20 ~ +70°C (Refer to output load derating curve)			
WORKING HUMIDITY	20 ~ 90% RH non-condensing			
STORAGE TEMP. / HUMIDITY	-40 ~ +85°C; 10 ~ 95% RH			
TEMP. COEFFICIENT	±0.03% / °C (0 ~ 50°C)			
VIBRATION	10 ~ 500Hz, 2G 10min. / 1cycle, 60 min. each long X,Y, Z axes			
SAFETY STANDARDS	UL508, TUV EN60950-1:2006+A11, UL1310 NEC class 2 compliant			
WITHSTAND VOLTAGE	I/P-O/P: 4242DC I/P-FG: 2121DC 1 minute			
ISOLATION RESISTANCE	I/P-O/P, I/P-FG, O/P-FG: 100M Ohms/500VDC			
EMI CONDUCTION & RADIATION	EN55022: 2006 Class B			
HARMONIC CURRENT	EN61000-3-2: 2006 Class A, EN61000-3-3: 1995+A1: 2001+A2: 2005			
EMS IMMUNITY	EN61204-3:2000, EN55024:1998+A1:2001+A2:2003 light industry level, criteria A			
The power supply is considered a component which will installed into a final equipment. The final equipment must be re-confirmed that it still meets EMC directives.				
DC OK Signal	Relay contact (30VDC / 1A, 120VAC / 1A)			
MTBF	947.2K hrs MIL-HDBK-217K			
DIMENSION	40x90x99 mm (WxHxD)			
PACKING	0.28Kg/27 pcs./8.76Kg			
CONNECTION	I/P 3 poles, O/P: 6 poles screw DIN terminal			
COOLING	Free air convection			
All parameters NOT specially mentioned are measured at 230V AC input, rated load and 25°C of ambient temperature.				

# PSC-40 Series

## Mechanical Specification

Unit : mm / inch

Terminal Pin. No Assign. (TB1)

Pin No.	Assignment
1	FG ⊕
2	AC/N
3	AC/L

Terminal Pin. No Assign. (TB2)

Pin No.	Assignment
1,2	DC OUTPUT +V
3,4	DC OUTPUT -V
5,6	DC OK RELAY CONTACT

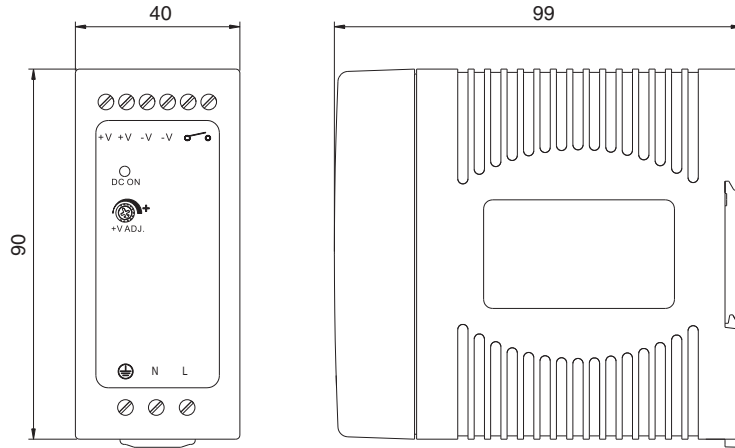

## Block Diagram

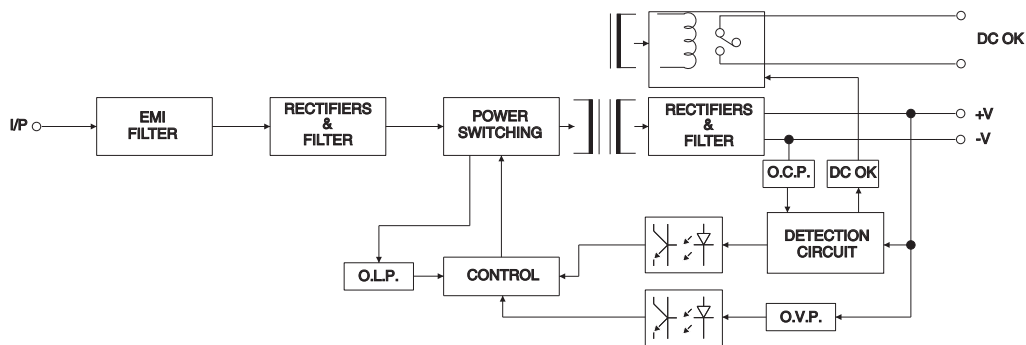

## DC OK Relay Contact

Contact Close	When the output voltage reaches the adjusted output voltage
Contact Open	When the output voltage drop below 90% rated output voltage
Contact Ratings (max.)	30V / 1A resistive load

## Derating Curve

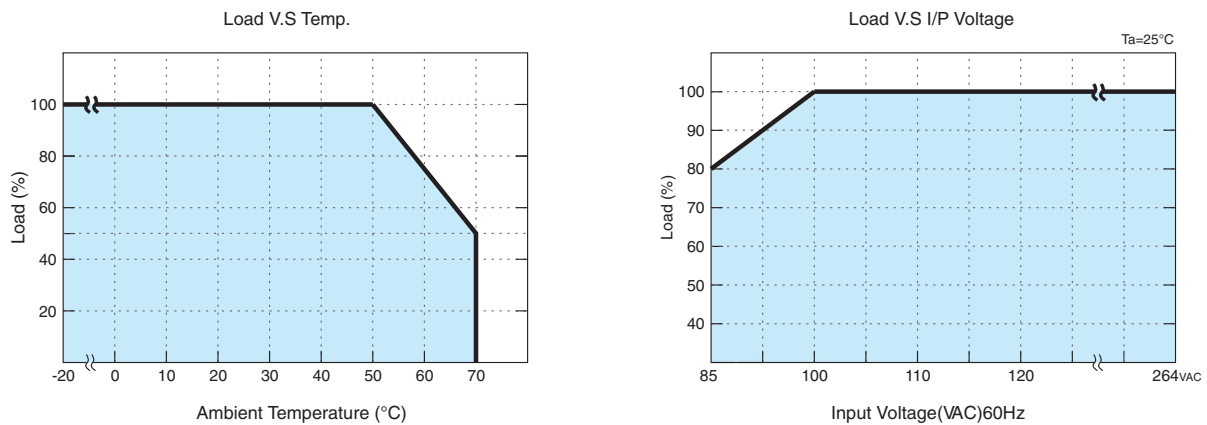

Note: All dimensions are in millimeters, to convert to inches multiply by 0.03937.





# PSC-60 Series



## Features:

- Universal AC input (88-264V AC)
- Protections: Short Circuit / Overload / Overvoltage
- Brown-out protection
- Installed on DIN rail TS35 / 7.5 or 15
- True DC OK signal output
- All wiring 105°C long life electrolytic capacitors
- High operation temperature up to 70°C
- Withstands 2G vibration test
- High efficiency, long life and high reliability
- 3 year warranty
- UL1310 Class 2 Power unit / LPS pass
- UL508 (Industrial control equipment) listed

## OUTPUT

## INPUT

## PROTECTION

## ENVIRONMENT

## SAFETY & EMC

## OUTPUT

Cat. No.	PSC-6012	PSC-6015	PSC-6024	PSC-6048
DC VOLTAGE	12V	15V	24V	48V
RATED CURRENT	5A	4A	2.5A	1.25A
CURRENT RANGE	0 ~ 5A	0 ~ 4A	0 ~ 2.5A	0 ~ 1.25A
RATED POWER	60W	60W	60W	60W
RIPPLE & NOISE (max)	100mVp-p	100mVp-p	120mVp-p	180mVp-p
VOLTAGE ADJ. RANGE	10.8 ~ 13.2V	13.5 ~ 16.5V	21.6 ~ 26.4V	43.2 ~ 52.8V
VOLTAGE TOLERANCE	±1.0%	±1.0%	±1.0%	±1.0%
LINE REGULATION	±1.0%	±1.0%	±1.0%	±1.0%
LOAD REGULATION	±1.0%	±1.0%	±1.0%	±1.0%
SETUP, RISE TIME	< 800ms, < 50ms / 230VAC at full load Length of set up time is measured at sold first start. Turning ON/OFF the power supply may lead to increase of the set up time.			
HOLD UP TIME (Typ.)	> 32ms / 230VAC; >16ms / 115VAC at full load			
VOLTAGE RANGE	88 ~ 264VAC; 124 ~ 370VDC Derating may apply in low input voltage. Please check the derating curve for more details.			
FREQUENCY RANGE	47~63Hz			
EFFICIENCY (Typ.)	86%	87%	87%	88%
AC CURRENT (Typ.)	1.3 A / 115VAC; 0.6A / 230VAC			
INRUSH CURRENT (Typ.)	COLD START 30A / 115VAC; 60A / 230VAC			
LEAKAGE CURRENT	<1mA / 230VAC			
OVER LOAD PROTECTION	> 102% rated output power Protection type: Constant current limiting, recovers automatically after fault condition is removed			
OVER VOLTAGE PROTECTION	115% ~ 150% rated output voltage Protection type: latch-off mode			
OVER TEMPERATURE PROTECTION	Power supply shut down at 70°C constant current limiting / output voltage goes to 0; re-power on to recover			
WORKING TEMP.	-20 ~ +70°C (Refer to output load derating curve)			
WORKING HUMIDITY	20 ~ 90% RH non-condensing			
STORAGE TEMP. / HUMIDITY	-40 ~ +85°C; 10 ~ 95% RH			
TEMP. COEFFICIENT	±0.03% / °C (0 ~ 50°C)			
VIBRATION	10 ~ 500Hz, 2G 10min. / 1cycle, 60 min. each long X,Y, Z axes			
SAFETY STANDARDS	UL508, TUV EN60950-1:2006+A11, UL1310 NEC class 2 compliant			
WITHSTAND VOLTAGE	I/P-O/P: 4242DC, I/P-FG: 2121DC 1 minute			
ISOLATION RESISTANCE	I/P-O/P, I/P-FG, O/P-FG: 100M Ohms/500VDC			
EMI CONDUCTION & RADIATION	EN55022: 2006 Class B			
HARMONIC CURRENT	EN61000-3-2: 2006 Class A, EN61000-3-3: 1995+A1: 2001+A2: 2005			
EMS IMMUNITY	EN61204-3: 2000, EN55024: 1998+A1:2001+A2: 2003 light industry level, criteria A The power supply is considered a component which will installed into a final equipment. The final equipment must be re-confirmed that it still meets EMC directives.			
DC OK Signal	Relay contact (24VDC / 1A, 120VAC / 1A)			
MTBF	944.6K HRS MIL-HDBK-217F			
DIMENSION	40x90x99 mm (WxHxD)			
PACKING	0.3kg; 27pcs / 9.3kg			
CONNECTION	I/P: 3 poles, O/P: 6 poles screw DIN terminal			
COOLING	Free air convection All parameters NOT specially mentioned are measured at 230V AC input, rated load and 25°C of ambient temperature.			

# PSC-60 Series

## Mechanical Specification

Unit : mm / inch

Terminal Pin. No Assign. (TB1)

Pin No.	Assignment
1	FG ⊕
2	AC/N
3	AC/L

Terminal Pin. No Assign. (TB2)

Pin No.	Assignment
1,2	DC OUTPUT +V
3,4	DC OUTPUT -V
5,6	DC OK RELAY CONTACT

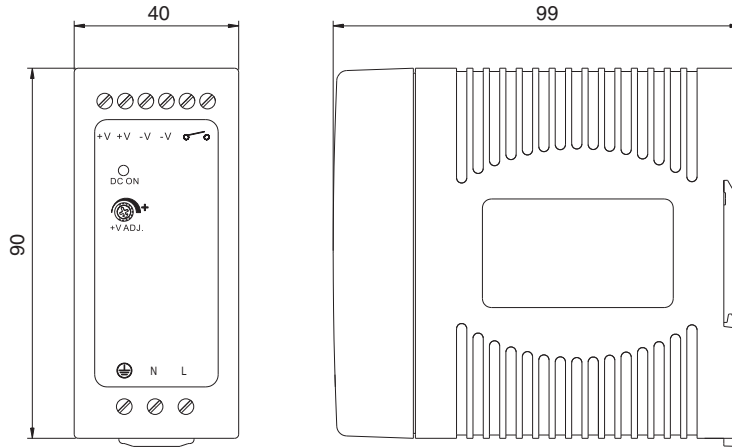

## Block Diagram

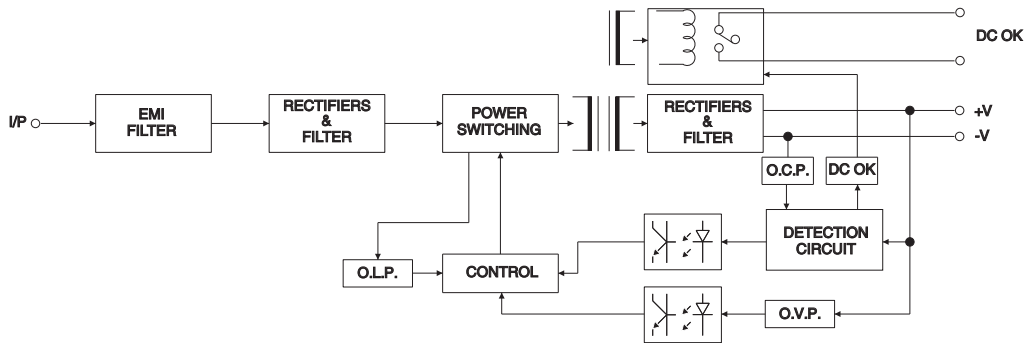

## DC OK Relay Contact

Contact Close	When the output voltage reaches the adjusted output voltage
Contact Open	When the output voltage drop below 90% rated output voltage
Contact Ratings (max.)	30V / 1A resistive load

## Derating Curve

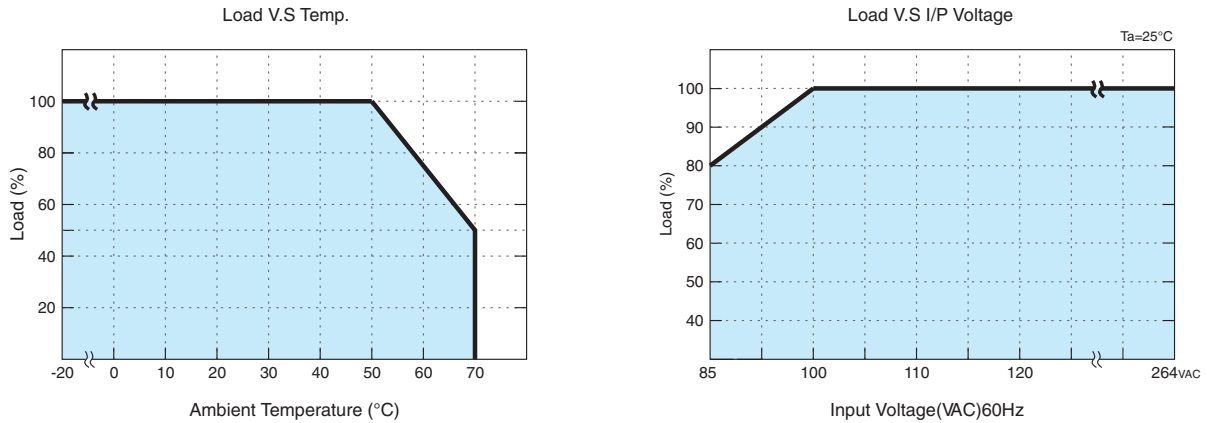

Note: All dimensions are in millimeters, to convert to inches multiply by 0.03937.



# PSC-96 Series



## Features:

- Universal AC input (88-264V AC)
- Protections: Short Circuit / Overload / Overvoltage
- Brown-out protection
- Installed on DIN rail TS35 / 7.5 or 15
- True DC OK signal output
- All wiring 105°C long life electrolytic capacitors
- High operation temperature up to 70°C
- Withstands 2G vibration test
- High efficiency, long life and high reliability
- 3 year warranty
- UL1310 Class 2 Power unit / LPS pass
- UL508 (Industrial control equipment) listed

## OUTPUT

## INPUT

## PROTECTION

## ENVIRONMENT

## SAFETY & EMC

## OUTPUT

Cat. No.	PSC-9612*	PSC-9615*	PSC-9624	PSC-9648
DC VOLTAGE	12V	15V	24V	48V
RATED CURRENT	7.5A	6.4A	4A	2A
CURRENT RANGE	0 ~ 7.5A	0 ~ 6.4A	0 ~ 4A	0 ~ 2A
RATED POWER	90W	96W	96W	96W
RIPPLE & NOISE (max)	180mVp-p	180mVp-p	180mVp-p	250mVp-p
Ripple & noise are measured at 20MHz of bandwidth by using a 12" twisted pair-wire terminated with a 0.1µF & 47µF parallel capacitor				
VOLTAGE ADJ. RANGE	10.8 ~ 13.2V	13.5 ~ 16.5V	21.6 ~ 26.4V	43.2 ~ 52.8V
VOLTAGE TOLERANCE	±1.0%	±1.0%	±1.0%	±1.0%
Tolerance: includes set up tolerance, line regulation and load regulation.				
LINE REGULATION	±1.0%	±1.0%	±1.0%	±1.0%
LOAD REGULATION	±2.0%	±2.0%	±2.0%	±2.0%
SETUP, RISE TIME	< 800ms, < 40ms / 230VAC at full load			
HOLD UP TIME (Typ.)	> 32ms / 230VAC; >16ms / 115VAC at full load			
VOLTAGE RANGE	88 ~ 264VAC; 124 ~ 370VDC Derating may apply in low input voltage. Please check the derating curve for more details.			
FREQUENCY RANGE	47Hz~63Hz			
POWER FACTOR (Typ.)	< 0.92 / 230VAC; < 0.98 / 115VAC at full load			
EFFICIENCY (Typ.)	87%	87%	88%	87%
AC CURRENT (Typ.)	1.1 A / 115VAC; 0.55A / 230VAC			
INRUSH CURRENT (Typ.)	COLD START 30A / 115VAC; 60A / 230VAC			
LEAKAGE CURRENT	<1mA / 230VAC			
OVER LOAD PROTECTION	> 102% rated output power Protection type: Constant current limiting, recovers automatically after fault condition is removed.			
OVER VOLTAGE PROTECTION	115% ~ 150% rated output voltage Protection type: latch-off mode			
OVER TEMPERATURE PROTECTION	90°C ± 10°C (RTH2) detect on heat sink of power transistor Protection type: Shut down overvoltage, re-power on to recover			
WORKING TEMP.	-20 ~ +70°C (Refer to output load derating curve)			
WORKING HUMIDITY	20 ~ 90% RH non-condensing			
STORAGE TEMP. / HUMIDITY	-40 ~ +85°C; 10 ~ 95% RH			
TEMP. COEFFICIENT	±0.03% / °C (0 ~ 50°C)			
VIBRATION	10 ~ 500Hz, 2G 10min. / 1cycle, 60 min. each long X,Y, Z axes			
SAFETY STANDARDS	UL508, TUV EN60950-1:2006+A11, UL1310 NEC class 2 compliant			
WITHSTAND VOLTAGE	I/P-O/P: 4242DC I/P-FG: 2121DC 1 minute			
ISOLATION RESISTANCE	I/P-O/P, I/P-FG, O/P-FG: 100M Ohms/500VDC			
EMI CONDUCTION & RADIATION	EN55022:2006 Class B			
HARMONIC CURRENT	EN61000-3-2:2006 Class A, EN61000-3-3: 1995+A1: 2001+A2: 2005			
EMS IMMUNITY	EN61204-3:2000, EN55024:1998+A1:2001+A2:2003 light industry level, criteria A The power supply is considered a component which will be installed into a final equipment. The final equipment must be re-confirmed that it still meets EMC directives.			
DC OK Signal	Relay contact (24VDC / 1A, 120VAC / 1A)			
MTBF	120.4K Hrs MIL-HDBK-217F			
DIMENSION	55x90x99 mm (WxHxD)			
PACKING	0.4Kg/24 pcs. / 10.8Kg			
CONNECTION	I/P 3 poles, O/P: 6 poles screw DIN terminal			
COOLING	Free air convection			
All parameters NOT specially mentioned are measured at 230V AC input, rated load and 25°C of ambient temperature.				

\*Not included in UL E361935

# PSC-96 Series

## Mechanical Specification

Unit : mm / inch

Terminal Pin. No Assign. (TB1)

Pin No.	Assignment
1	FG ⊕
2	AC/N
3	AC/L

Terminal Pin. No Assign. (TB2)

Pin No.	Assignment
1,2	DC OUTPUT +V
3,4	DC OUTPUT -V
5,6	DC OK RELAY CONTACT

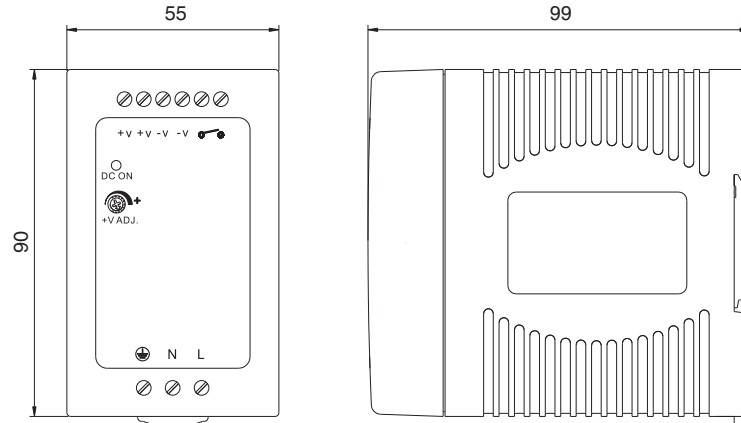

## Block Diagram

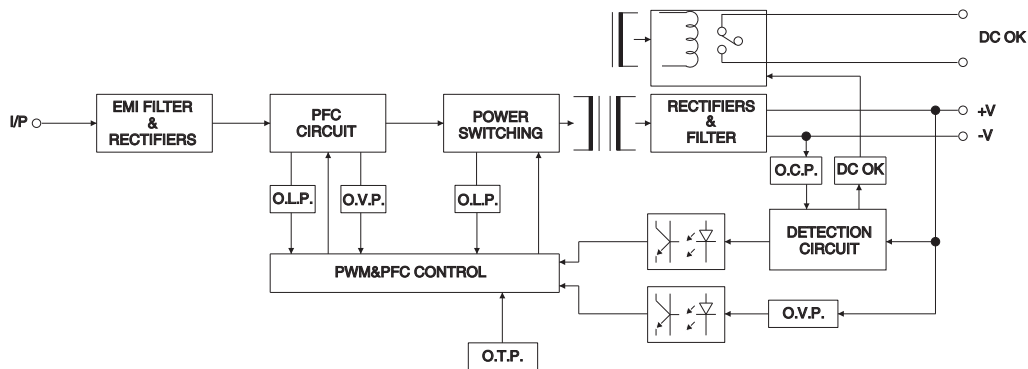

## DC OK Relay Contact

Contact Close	When the output voltage reaches the adjusted output voltage
Contact Open	When the output voltage drop below 90% rated output voltage
Contact Ratings (max.)	30V / 1A resistive load

## Derating Curve

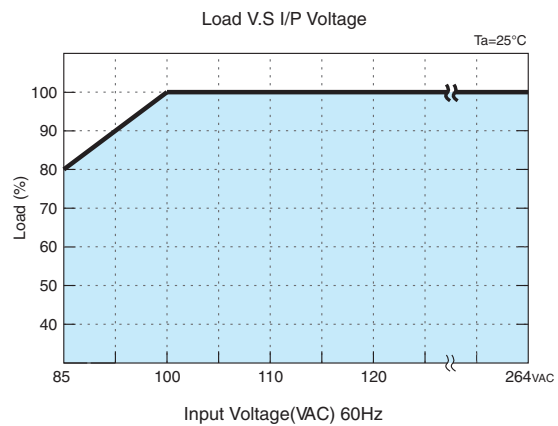
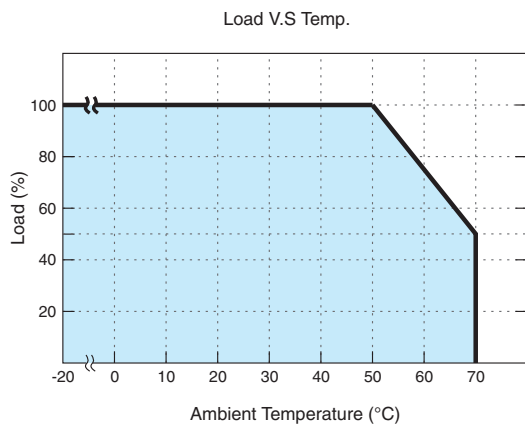

Note: All dimensions are in millimeters, to convert to inches multiply by 0.03937.



# Compact Single Phase Power Supply (PSC)



## Features:

- Universal AC input (88-264V AC)
- Installed on DIN rail TS-35 / 7.5 or 15
- Built-in active PFC function, PF > 0.95
- 150% peak load capability
- 100% full load burn-in test
- Protection: SCP, OLP, OVP, OTP
- Two selectable peak load modes
- Built-in DC OK Relay contact
- Built-in Remote ON / OFF function
- 3 years warranty
- UL 508



## 150W DIN Rail Power Supply

Cat. No.	Phases	Output V DC A	Tol. %	Ripple & Noise	Efficiency	NOTES
PSC-15124	1	24V DC 6.3A	±1%	≤240 mVp-p	≥87%	
PSC-15148	1	48V DC 3.2A	±1%	≤480 mVp-p	≥87%	



## 240W DIN Rail Power Supply

Cat. No.	Phases	Output V DC A	Tol. %	Ripple & Noise	Efficiency	NOTES
PSC-24124	1	24V DC 10A	±1%	≤150 mVp-p	≥91%	
PSC-24148	1	48V DC 5A	±1%	≤300 mVp-p	≥92%	



## 480W DIN Rail Power Supply

Cat. No.	Phases	Output V DC A	Tol. %	Ripple & Noise	Efficiency	NOTES
PSC-48124	1	24V DC 20A	±1%	≤240 mVp-p	≥93%	
PSC-48148	1	48V DC 10A	±1%	≤480 mVp-p	≥94%	



## 20A DIN Rail Redundancy Module

Cat. No.	Phases	Output V DC A	Input VDC	Input A	NOTES
PSC-RM20	1	24V DC 20A	24VDC	2x20A	

\*\*Other output voltages on request.

# SPECIFICATIONS

## PSC-151 Series

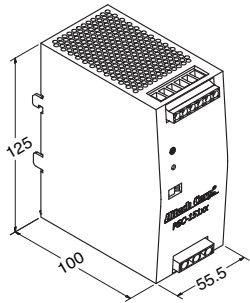

Terminal Pin No. Assignment (TB1)

Pin NO.	Assignment
1	FG ⊕
2	AC/L
3	AC/N

Terminal Pin No. Assignment (TB2)

Pin NO.	Assignment
1	DC+
2	DC-
3	INH+
4	INH-
5,6	Relay Contact

Switch No. Assignment

SW NO.	Assignment
SW1	PEAK LOAD SETTING
SW2	REMOTE ON/OFF SETTING

- Universal Input:** 2.0A @ 115VAC / 1.0A @ 230VAC  
**Connection Input:** 2 poles, single screw terminal  
**Connection Output:** 2 poles, single screw terminal  
**Size (WxHxD):** 55.5x12.5x100 mm (2.19x4.92x3.93 in.)  
**Packaging:** 1/box; 0.72kg (1.6 lbs)

## PSC-241 Series

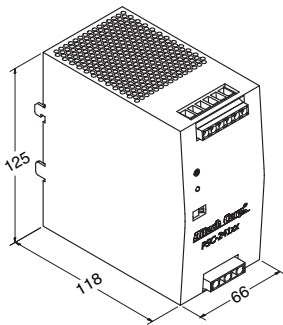

Terminal Pin No. Assignment (TB1)

Pin NO.	Assignment
1	FG ⊕
2	AC/L
3	AC/N

Terminal Pin No. Assignment (TB2)

Pin NO.	Assignment
1	DC+
2	DC-
3	INH+
4	INH-
5,6	Relay Contact

Switch No. Assignment

SW NO.	Assignment
SW1	PEAK LOAD SETTING
SW2	REMOTE ON/OFF SETTING

- Universal Input:** 2.6A @ 115VAC / 1.3A @ 230VAC  
**Connection Input:** 2 poles, single screw terminal  
**Connection Output:** 2 poles, single screw terminal  
**Size (WxHxD):** 66x12.5x118 mm (2.6x4.9x4.65 in.)  
**Packaging:** 1/box; 0.9kg (2.0 lbs)

## PSC-481 Series

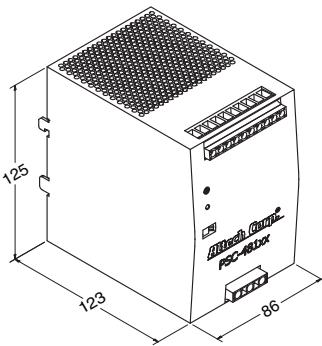

Terminal Pin No. Assignment (TB1)

Pin NO.	Assignment
1	FG ⊕
2	AC/L
3	AC/N

Terminal Pin No. Assignment (TB2)

Pin NO.	Assignment
1-3	DC+
4-6	DC-
7	INH+
8	INH-
9,10	DCOK Signal

Switch No. Assignment

SW NO.	Assignment
SW1	PEAK LOAD SETTING
SW2	REMOTE ON/OFF SETTING

- Universal Input:** 5.0A @ 115VAC / 2.5A @ 230VAC  
**Connection Input:** 2 poles, single screw terminal  
**Connection Output:** 2 poles, single screw terminal  
**Size (WxHxD):** 86x12.5x123 mm (3.4x4.9x4.85 in.)  
**Packaging:** 1/box; 1.45kg (3.2 lbs)

## PSC-RM20

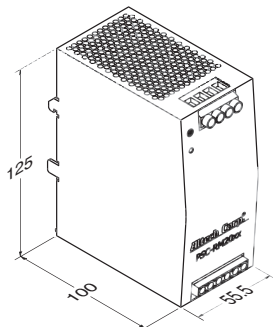

Terminal Pin. No Assignment (TB1)

Pin No.	Assignment
1	Vout+
2	Vout-
3,4	Vin-
5	Vin B+
6	Vin A+

Terminal Pin. No Assignment (TB2)

Pin No.	Assignment
1	Alarm B1
2	Alarm B2
3	Alarm A1
4	Alarm A2

- Input:** 2x20A @ 24VDC  
**Connection Input:** 2 poles, single screw terminal  
**Connection Output:** 2 poles, single screw terminal  
**Size (WxHxD):** 55.5x12.5x100 mm (2.19x4.92x3.93 in.)  
**Packaging:** 1/box; 0.72kg (1.6 lbs)



# PSC-151 Series



## Features:

- Universal AC input (88-264V AC)
- Installed on DIN rail TS-35 / 7.5 or 15
- Built-in active PFC function, PF > 0.95
- 150% peak load capability
- 100% full load burn-in test
- Protection: SCP, OLP, OVP, OTP
- Two selectable peak load modes
- Built-in DC OK Relay contact
- Built-in Remote ON / OFF function
- 3 years warranty
- UL 508

## OUTPUT

Cat. No.	PSC-15124	PSC-15148
----------	-----------	-----------

DC VOLTAGE	24V	48V
RATED CURRENT	6.3A	3.2A
CURRENT RANGE	0~6.3A	0~3.2A
RATED POWER	150W	150W
PEAK CURRENT	9.45A	4.8A
PEAK POWER	225W (3sec.)	
	3 seconds or 20% duty cycle max. and the average output power should not exceed the rate power.	
RIPPLE & NOISE (max)	240mVp-p	480mVp-p
	Ripple & noise are measured at 20MHz of bandwidth by using a 12" twisted pair-wire terminated with a 0.1µF & 47µF parallel capacitor.	
VOLTAGE ADJ. RANGE	-2% ~ +8%	-2% ~ +8%
VOLTAGE TOLERANCE	±1.0%	±1.0%
	Tolerance: includes set up tolerance, line regulation and load regulation.	
LINE REGULATION	±0.5%	±0.5%
LOAD REGULATION	±1.0%	±1.0%
SETUP, RISE TIME	700ms, 30ms / 230VAC / 115VAC at full load	
HOLD UP TIME (Typ.)	16ms / 230VAC; 16ms / 115VAC at full load	

## INPUT

VOLTAGE RANGE	88 ~ 264VAC; 124 ~ 373VDC	
	Derating may apply in low input voltage. Please check the derating curve for more details.	
FREQUENCY RANGE	47 ~ 63Hz	
POWER FACTOR(Typ.)	0.9 / 230VAC; 0.98 / 115VAC at full load	
EFFICIENCY (Typ.)	87%	87%
AC CURRENT (Typ.)	2.0A / 115VAC; 1.0A / 230VAC	
INRUSH CURRENT (Typ.)	33A / 115VAC; 65A / 230VAC	
LEAKAGE CURRENT	<1mA/ 240VAC	

## PROTECTION

OVERLOAD PROTECTION	105% ~ 150% rated output power for 3 sec and then shutdown in O/P with auto-recovery. 150% or greater rated power or short circuit is constant current limiting. If O/P drops to 40% output then it auto-recover 5 times; if fault condition is not removed during auto recovery, the system will shut down and needs to be restarted to recover.	
OVER VOLTAGE	29 ~ 33V	56 ~ 65V
	Protection type: Latch-off mode, repower on to recover.	
OVER TEMPERATURE	95 ±5°C (TSW: detect on heatsink of power diode) Protection type: Shut down o/p voltage, recovers automatically after temperature goes down	

## ENVIRONMENT

WORKING TEMP.	-10 ~ +70°C (Refer to derating curve) Installation clearance: 40mm from top, 20mm from bottom, 5mm from the left and right side are recommended when loaded permanently with full power. In case the adjacent device is a heat source, 15mm clearance is recommended.	
WORKING HUMIDITY	20 ~ 95% RH non-condensing	
STORAGE TEMP. / HUMIDITY	-40 ~ +85°C, 10 ~ 95% RH	
TEMP. COEFFICIENT	±0.03% / °C (0 ~ 50°C)	
VIBRATION	10 ~ 500Hz, 2G 10min. / 1cycle, 60min. each along X, Y, Z axes	

## SAFETY & EMC

SAFETY STANDARDS	UL 508 / TUV EN 60950-1	
WITHSTAND VOLTAGE	I/P-O/P: 4242VDC, I/P-FG: 2121VDC, O/P-FG: 707VDC, O/P-DC OK: 707VDC	
ISOLATION RESISTANCE	I/P-O/P, I/P-FG, O/P-FG: >100M Ohms / 500VDC / 25°C / 70% RH	
EMI CONDUCTION & RADIATION	EN55022 (CISPR22) Class B	
HARMONIC CURRENT	EN61000-3-2, -3	
EMS IMMUNITY	Compliance to EN61000-4-2,3,4,5,6,8,11; ENV50204; EN55024; EN61000-6-2; (EN50082-2); EN61204-3; heavy industry level; criteria A, MEET SEMI F47 The power supply is considered a component which will installed into a final equipment. The final equipment must be re-confirmed that it still meets EMC directives.	

## OUTPUT

DC OK RELAY. CONTACT RATINGS (max)	60VDC / 0.3A, 30VDC / 1A, 30VAC / 0.5A resistive load	
MTBF	62.7K HRS (MIL-HDBK-217F)	
DIMENSION	55.5x125.2x99.8 mm (WxHxD)	
PACKING	0.72kg; 12pcs / 12.8kg	
COOLING	Free air convection	
	All parameters NOT specially mentioned are measured at 230VAC input, rated load and 25°C of ambient temperature.	

# PSC-151 Series

## Mechanical Specification

Terminal Pin No. Assignment (TB1)

Pin NO.	Assignment
1	FG ⊕
2	AC/L
3	AC/N

Terminal Pin No. Assignment (TB2)

Pin NO.	Assignment
1	DC+
2	DC-
3	INH+
4	INH-
5,6	Relay Contact

Switch No. Assignment

SW NO.	Assignment
SW1	PEAK LOAD SETTING
SW2	REMOTE ON/OFF SETTING

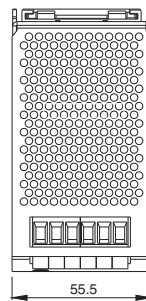

Unit : mm / inch

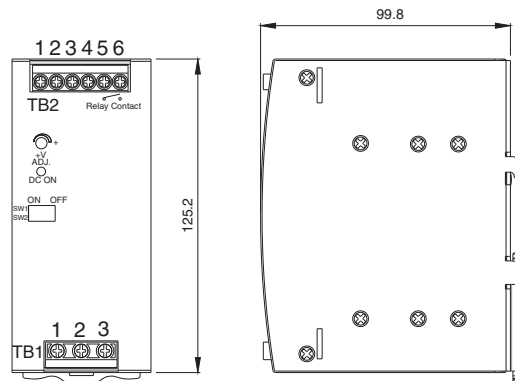

## Block Diagram

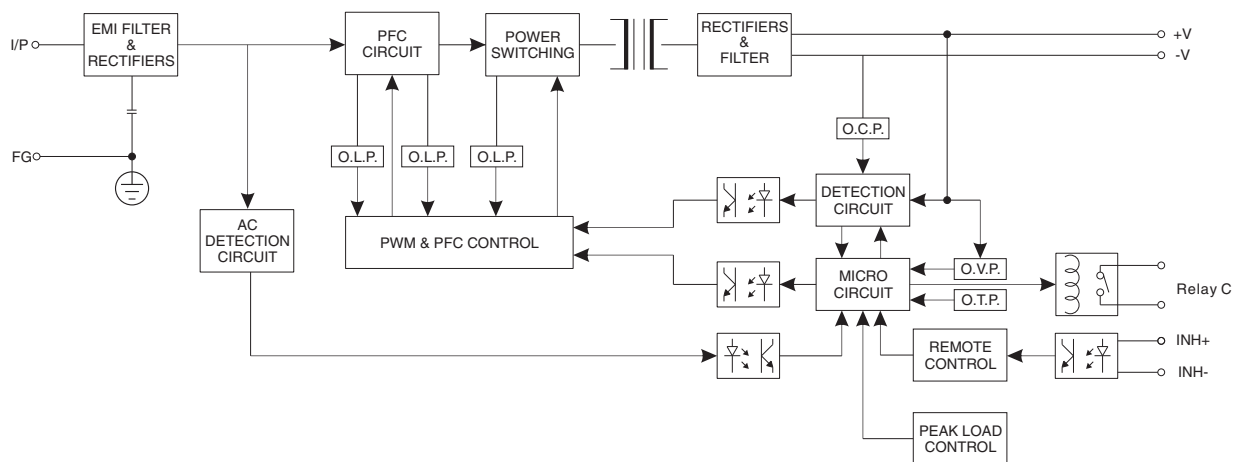

## DC OK Relay Contact

Contact Close	When the output voltage reaches the adjusted output voltage.
Contact Open	When the output voltage drop below 45% rated output voltage.
Contact Ratings(max.)	30V/1A resistive load

Note: All dimensions are in millimeters, to convert to inches multiply by 0.03937.





# PSC-151 Series



## Peak Load SW1 ON (Mode1) Default setting

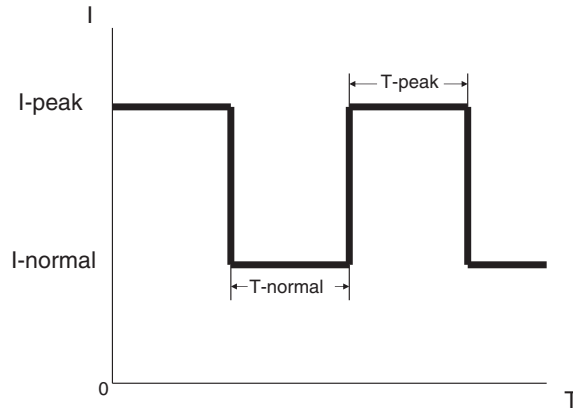

T-peak presents while the unit is working within 110%~150% Rating output power. See curve " B " for the variation in T-peak between output current and holdup time. If T-peak is more than the time setting in curve "B", the output current will drop to the constant current limit (I-normal) that is 105% rating power, meanwhile, I-normal and T-normal will be presenting. See curve "A" for the timing back to I-Peak of T-normal and this Mode can use for easy 2-stage battery charger.

## Peak Load SW2 OFF (Mode2)

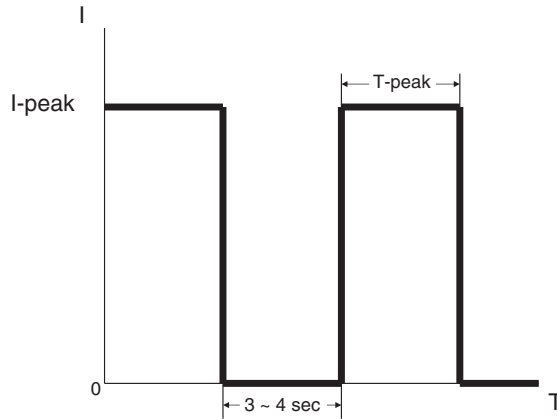

T-peak presents while the unit is working within 110%~150% Rating output power. See curve " B " for the variation in T-peak between output current and holdup time. If T-peak is more than the time setting in curve "B", the output current will be shut down for 3~4 sec, then auto-recovery.

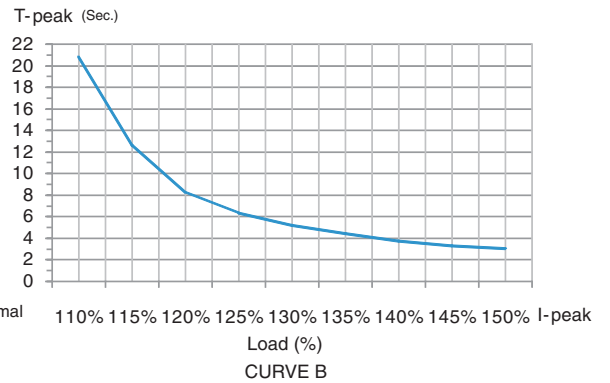
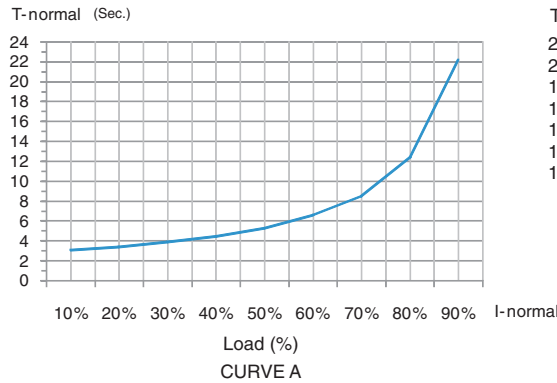

# PSC-151 Series

## Remote ON/OFF

The PSU can be turned ON/OFF by using the "Remote Control" function.

SW2	INH+(3 PIN)/INH-(4 PIN)	Output Status
OFF	SW ON (>2.5V)	ENABLE
OFF	SW OFF (<0.8V)	DISABLE
ON	SW ON (>2.5V)	DISABLE
ON	SW OFF (<0.8V)	ENABLE

(Default Setting)

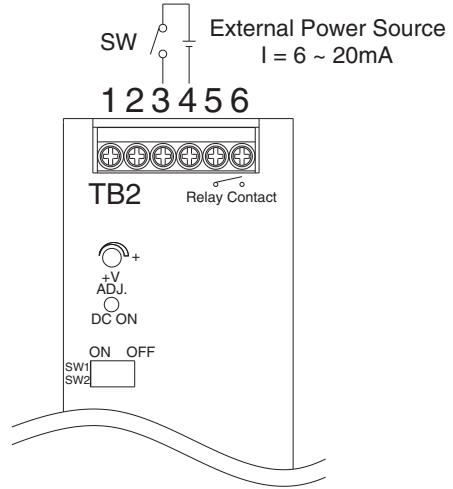

## Derating Curve

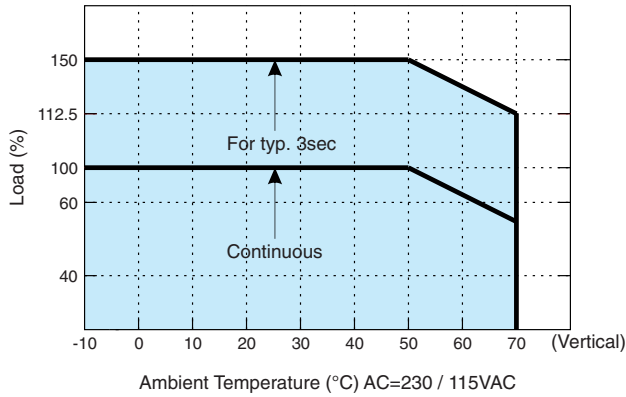

## Output derating VS input Voltage

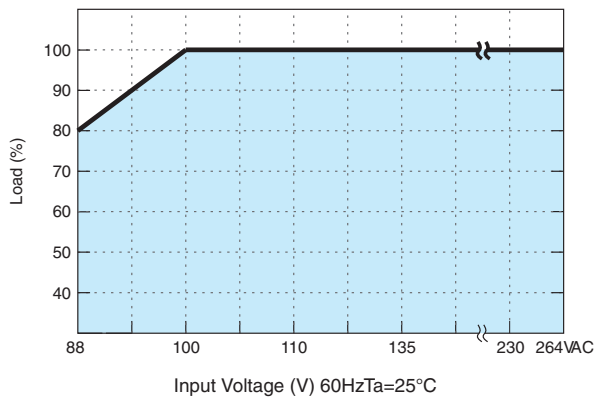



# PSC-241 Series



## Features:

- Universal AC input (88-264V AC)
- High efficiency 92% and low power dissipation
- Installed on DIN rail TS-35 / 7.5 or 15
- Built-in active PFC function, PF > 0.95
- 150% peak load capability
- 100% full load burn-in test
- Protection: SCP, OLP, OVP, OTP
- Two selectable peak load modes
- Built-in DC OK Relay contact
- Built-in Remote ON / OFF function
- 3 years warranty
- UL 508

## OUTPUT

Cat. No.	PSC-24124	PSC-24148
----------	-----------	-----------

DC VOLTAGE	24V	48V
RATED CURRENT	10A	5A
CURRENT RANGE	0~10A	0~5A
RATED POWER	240W	240W
PEAK CURRENT	15A	7.5A
PEAK POWER	360W (3sec.) Two selectable peak load modes 3 seconds or 20% duty cycle Max. The average output power should not exceed the rate power.	
RIPPLE & NOISE (max)	150mVp-p Ripple & noise are measured at 20MHz of bandwidth by using a 12" twisted pair-wire terminated with a 0.1µF & 47µF parallel capacitor.	300mVp-p
VOLTAGE ADJ. RANGE	-2% ~ +8%	-2% ~ +8%
VOLTAGE TOLERANCE	±1.0%	±1.0%
LINE REGULATION	±0.5%	±0.5%
LOAD REGULATION	±1.0%	±1.0%
SETUP, RISE TIME	700ms, 30ms / 230VAC / 115VAC at full load	
HOLD UP TIME (Typ.)	20ms / 230VAC; 20ms / 115VAC at full load	

## INPUT

VOLTAGE RANGE	88 ~ 264VAC; 124 ~ 373VDC Derating may apply in low input voltage. Please check the derating curve for more details.	
FREQUENCY RANGE	47 ~ 63Hz	
POWER FACTOR (Typ.)	0.96 / 230VAC; 0.96 / 115VAC at full load	
EFFICIENCY (Typ.)	91%	92%
AC CURRENT (Typ.)	2.6A / 115VAC; 1.3A / 230VAC	
INRUSH CURRENT (Typ.)	33A / 115VAC; 65A / 230VAC	
LEAKAGE CURRENT	<1mA/ 240VAC	

## PROTECTION

OVERLOAD	105% ~ 150% rated output power for 3 sec and then shutdown in O/P with auto-recovery. 150% or greater rated power or short circuit is constant current limiting. If O/P drops to 40% output then it auto-recover 5 times; if fault condition is not removed during auto recovery, the system will shut down and needs to be restarted to recover.	
OVER VOLTAGE	28 ~ 33V Protection type: Shut down O/P voltage with auto-recovery	56 ~ 65V
OVER TEMPERATURE	95 ±5°C (TSW: detect on heatsink of power diode) Protection type: Shut down o/p voltage, recovers automatically after temperature goes down	

## ENVIRONMENT

WORKING TEMP.	-25 ~ +70°C (Refer to output load derating curve) Installation clearances: 40mm on top, 20mm on the left and right side are recommended when loaded permanently with full power. In case the adjacent device is a heat source, 15mm clearance is recommended.	
WORKING HUMIDITY	20 ~ 95% RH non-condensing	
STORAGE TEMP. / HUMIDITY	-40 ~ +85°C; 10 ~ 95% RH	
TEMP. COEFFICIENT	±0.03% °C (0 ~ 50°C)	
VIBRATION	10 ~ 500Hz, 2G 10min. / 1cycle, 60 min. each long X,Y, Z axes	

## SAFETY & EMC

SAFETY STANDARDS	UL508, TUV EN60950-1		
WITHSTAND VOLTAGE	I/P-O/P: 4242VDC	I/P-FG2121VDC	O/P-F/G: 707VDC O/P-DC OK: 707VDC
ISOLATION RESISTANCE	I/P-O/P, I/P-FG, O/P-FG: > 100M Ohms / 500VDC / 25°C / 70% RH		
EMI CONDUCTION & RADIATION	EN55022:2006 Class B		
HARMONIC CURRENT	EN61000-3-2: 2006 Class A, ENG1000-3-3: 1995+A1: 2001+A2: 2005		
EMS IMMUNITY	EN61204-3: 2000, EN55024: 1998+A1: 2001+A2: 2003 light industry level, criteria A The power supply is considered a component which will installed into a final equipment. The final equipment must be re-confirmed that it still meets EMC directives.		

## OUTPUT

DC OK RELAY CONTACT RATINGS (max)	60VDC / 0.3A, 30VDC / 1A, 30VAC / 0.5A resistive load		
MTBF	57K HRS (MIL-HDBK-217F)		
DIMENSION	65.8x125.2x117.7 mm (WxHxD)		
PACKING	0.9kg; 12pcs / 12.8kg		
COOLING	Free air convection		

All parameters NOT specially mentioned are measured at 230VAC input, rated load and 25°C of ambient temperature.

# PSC-241 Series

## Mechanical Specification

Unit : mm / inch

### Terminal Pin No. Assignment (TB1)

Pin NO.	Assignment
1	FG ⊕
2	AC/L
3	AC/N

### Terminal Pin No. Assignment (TB2)

Pin NO.	Assignment
1	DC+
2	DC-
3	INH+
4	INH-
5,6	Relay Contact

### Switch No. Assignment

SW NO.	Assignment
SW1	PEAK LOAD SETTING
SW2	REMOTE ON/OFF SETTING

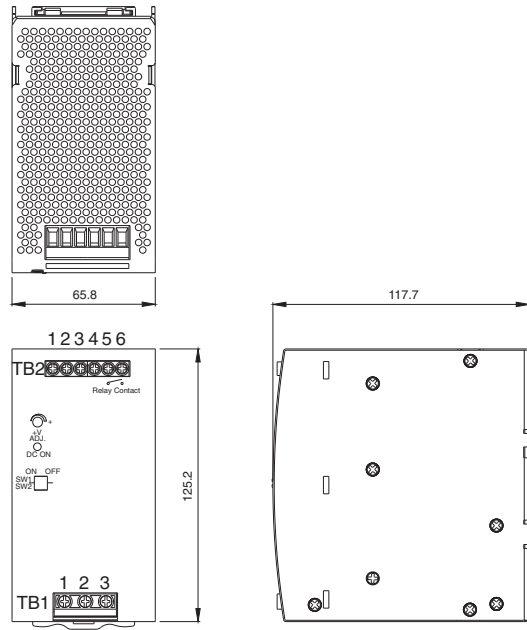

## Block Diagram

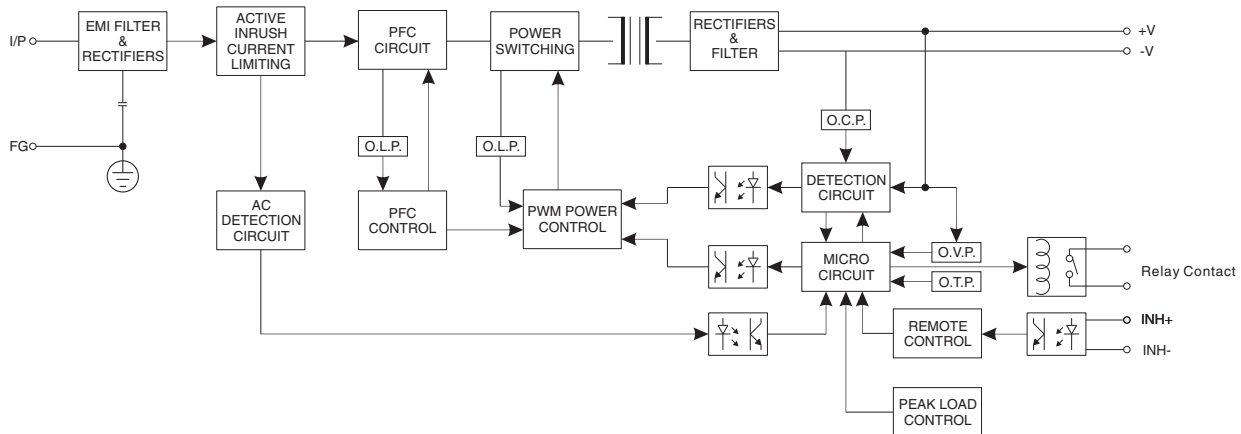

## DC OK Relay Contact

Contact Close	When the output voltage reaches the adjusted output voltage.
Contact Open	When the output voltage drop below 45% rated output voltage.
Contact Ratings(max.)	30V/1A resistive load

Note: All dimensions are in millimeters, to convert to inches multiply by 0.03937.





# PSC-241 Series



## Peak Load SW1 ON (Mode1) Default setting

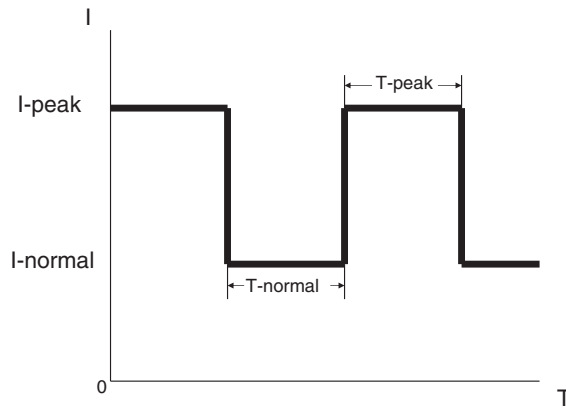

T-peak presents while the unit is working within 110%~150% Rating output power. See curve " B " for the variation in T-peak between output current and holdup time. If T-peak is more than the time setting in curve "B", the output current will drop to the constant current limit (I-normal) that is 105% rating power, meanwhile, I-normal and T-normal will be presenting. See curve "A" for the timing back to I-Peak of T-normal and this Mode can use for easy 2-stage battery charger.

## Peak Load SW2 OFF (Mode2)

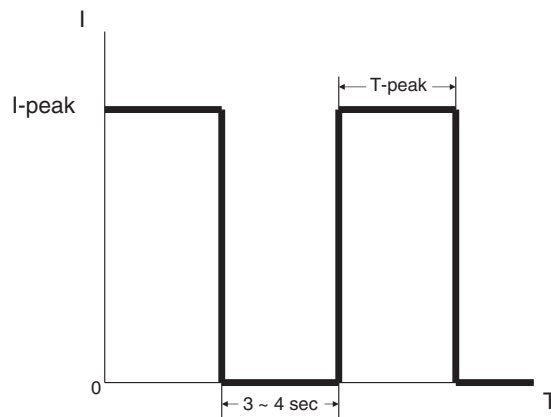

T-peak presents while the unit is working within 110%~150% Rating output power. See curve " B " for the variation in T-peak between output current and holdup time. If T-peak is more than the time setting in curve "B", the output current will be shut down for 3~4 sec, then auto-recovery.

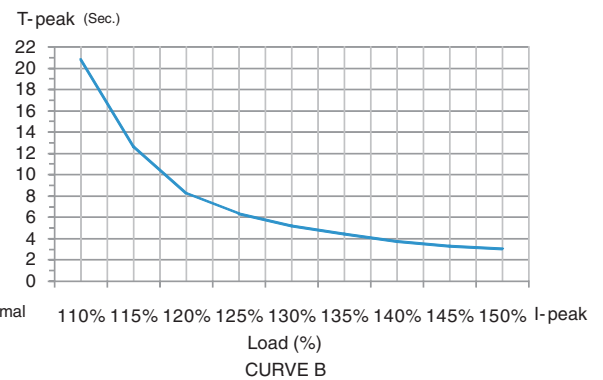
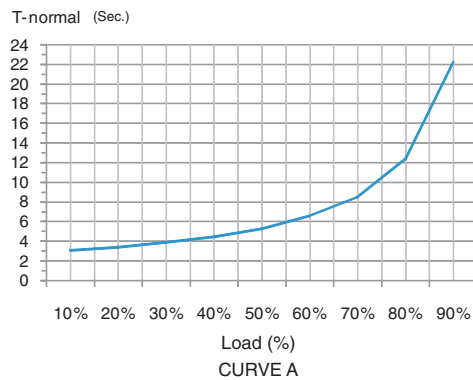

# PSC-241 Series

## Remote ON/OFF

The PSU can be turned ON/OFF by using the "Remote Control" function.

SW2	INH+(3 PIN)/ INH-(4 PIN)	Output Status
OFF	SW ON (>2.5V)	ENABLE
OFF	SW OFF (<0.8V)	DISABLE
ON	SW ON (>2.5V)	DISABLE
ON	SW OFF (<0.8V)	ENABLE

(Default Setting)

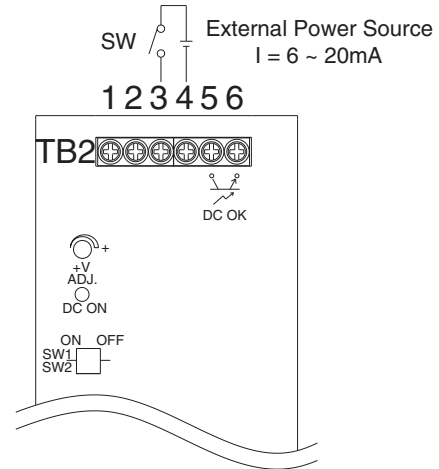

## Derating Curve

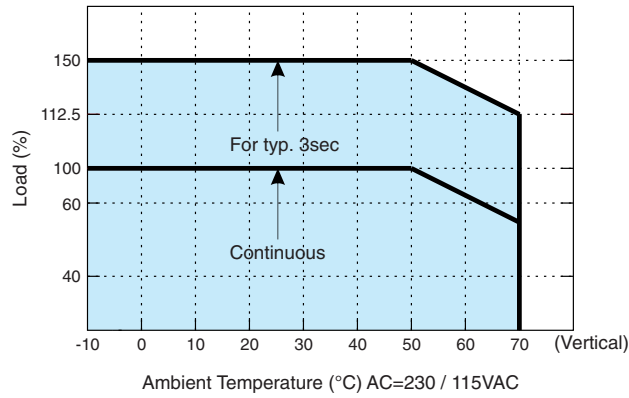

## Output derating VS input Voltage

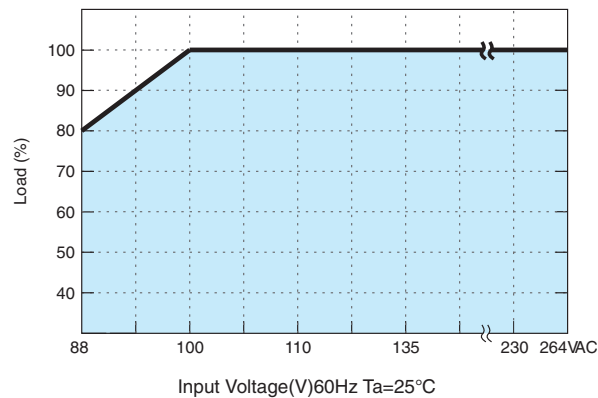



# PSC-481 Series



## Features:

- Universal AC input (88-264V AC)
- Installed on DIN rail TS-35 / 7.5 or 15
- Built-in active PFC function, PF > 0.95
- 150% peak load capability
- Protection: SCP, OLP, OVP, OTP
- Two selectable peak load modes
- Built-in DC OK (Open Collector Signal)
- Built-in Remote ON / OFF function
- 3 years warranty
- UL 508

## OUTPUT

Cat. No.	PSC-48124	PSC-48148
----------	-----------	-----------

DC VOLTAGE	24V	48V
RATED CURRENT	20A	10A
CURRENT RANGE	0~20A	0~10A
RATED POWER	480W	480W
PEAK CURRENT	30A	15A
PEAK POWER	720W (3sec.) Two selectable peak load modes 3 seconds or 20% duty cycle Max. The average output power should not exceed the rate power.	
RIPPLE & NOISE (max)	240mVp-p Ripple & noise are measured at 20MHz of bandwidth by using a 12" twisted pair-wire terminated with a 0.1µF & 47µF parallel capacitor.	480mVp-p
VOLTAGE ADJ. RANGE	-5% ~ +5%	
VOLTAGE TOLERANCE	±1.0%	±1.0%
	Tolerance: includes set up tolerance, line regulation and load regulation.	
LINE REGULATION	±0.5%	±0.5%
LOAD REGULATION	±1.0%	±1.0%
SETUP, RISE TIME	800ms, 100ms / 230VAC / 115VAC at full load	
HOLD UP TIME (Typ.)	16ms / 230VAC; 16ms / 115VAC at full load	

## INPUT

VOLTAGE RANGE	88 ~ 264VAC; 124 ~ 373VDC Derating may apply in low input voltage. Please check the derating curve for more details.	
FREQUENCY RANGE	47 ~ 63Hz	
POWER FACTOR (Typ.)	0.96 / 230VAC / 115VAC at full load	
EFFICIENCY (Typ.)	93%	94%
AC CURRENT (Typ.)	5.0A / 115VAC; 2.5A / 230VAC	
INRUSH CURRENT (Typ.)	33A / 115VAC; 65A / 230VAC	
LEAKAGE CURRENT	< 1mA / 240VAC	

## PROTECTION

OVERLOAD	105% ~ 150% rated output power for 3 sec and then shutdown in O/P with auto-recovery. 150% or greater rated power or short circuit is constant current limiting. If O/P drops to 40% output then it auto-recover 5 times; if fault condition is not removed during auto recovery, the system will shut down and needs to be restarted to recover.	
OVER VOLTAGE	29 ~ 33V Protection type: Latch-off mode.	56 ~ 65V
OVER TEMPERATURE	95 ±5°C (TSW: detect on heatsink of power diode) Protection type: Shut down o/p voltage, recovers automatically after temperature goes down	

## ENVIRONMENT

WORKING TEMP.	-20 ~ +70°C (Refer to output load derating curve) Installation clearance: 40mm from top, 20mm from the left and right side are recommended when loaded permanently with full power. In case the adjacent device is a heat source, 15mm clearance is recommended.	
WORKING HUMIDITY	20 ~ 95% RH non-condensing	
STORAGE TEMP. / HUMIDITY	-40 ~ +85°C; 10 ~ 95% RH	
TEMP. COEFFICIENT	±0.03% / °C (0 ~ 50°C)	
VIBRATION	10 ~ 500Hz, 2G 10min. / 1 cycle, 60 min. each long X, Y, Z axes	

## SAFETY & EMC

SAFETY STANDARDS	UL 508 / EN 60950-1	
WITHSTAND VOLTAGE	I/P-O/P: 4242VDC, I/P-FG: 2121VDC, O/P-FG: 707VDC, O/P-DC OK: 707VDC	
ISOLATION RESISTANCE	I/P-O/P, I/P-FG, O/P-FG: >100M Ohms / 500VDC / 25°C / 70% RH	
EMI CONDUCTION & RADIATION	EN 55022 (CISPR22), EN 61000-6-3	
HARMONIC CURRENT	EN61000-3-2, -3-3	
EMS IMMUNITY	IEC 61000-4-2, 3, 4, 5, 6, 8, 11; EN 61000-6-1; EN 61204-3 The power supply is considered a component which will be installed into a final equipment. The final equipment must be re-confirmed that it still meets EMC directives.	

## OUTPUT

DC OK RELAY CONTACT RATINGS (max)	60VDC / 0.3A, 30VDC / 1A, 30VAC / 0.5A resistive load	
DIMENSION	86.3x124.8x123.4 mm (WxHxD)	
PACKING	1.45kg; 8pcs / 12kg All parameters NOT specially mentioned are measured at 230VAC input, rated load and 25°C of ambient temperature.	

# PSC-481 Series

## Mechanical Specification

Unit : mm / inch

Terminal Pin No. Assignment (TB1)

Pin NO.	Assignment
1	FG ⊕
2	AC/L
3	AC/N

Terminal Pin No. Assignment (TB2)

Pin NO.	Assignment
1-3	DC+
4-6	DC-
7	INH+
8	INH-
9,10	DC OK Singal

Switch No. Assignment

SW NO.	Assignment
SW1	PEAK LOAD SETTING
SW2	REMOTE ON/OFF SETTING

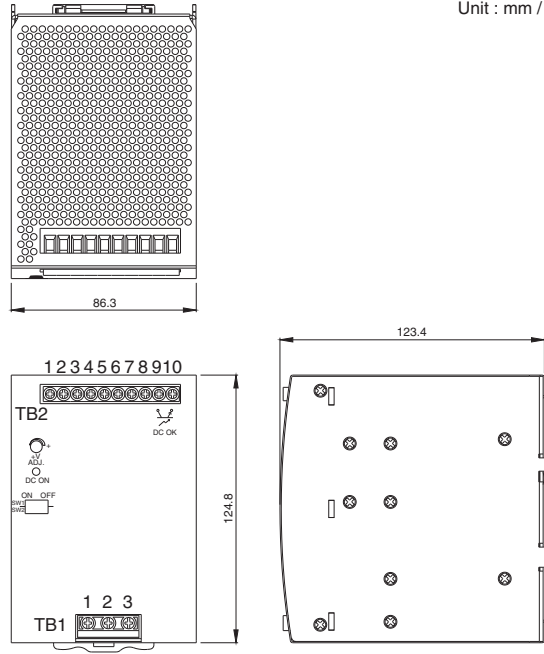

## Block Diagram

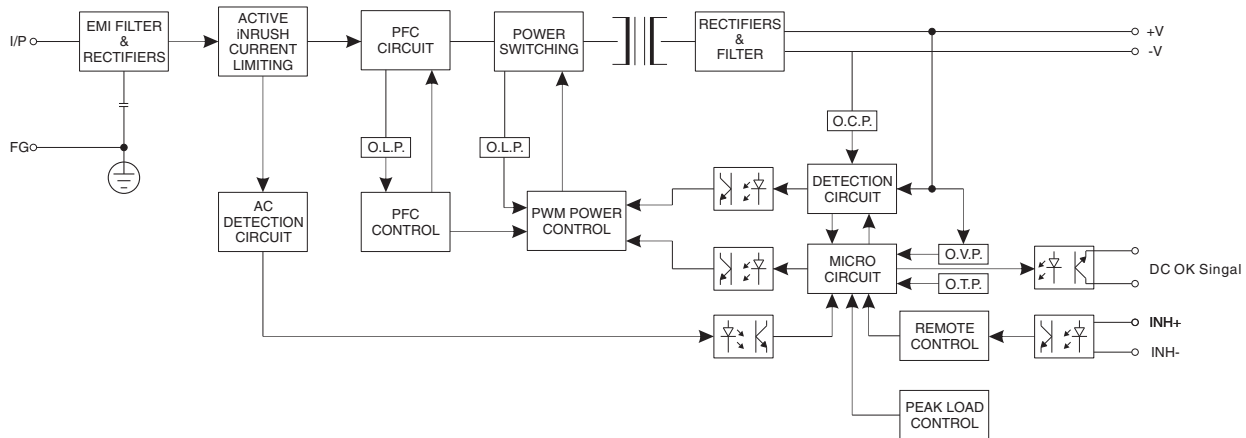

## DC OK Relay Contact

Contact Ratings(max.)	CTR : MIN. 50% at $I_f = 5mA, V_{ce} = 5V$
Isolation Voltage	Between input and output Viso = 3750Vrms

Note: All dimensions are in millimeters, to convert to inches multiply by 0.03937.





# PSC-481 Series



## Peak Load SW1 ON (Mode1) Default setting

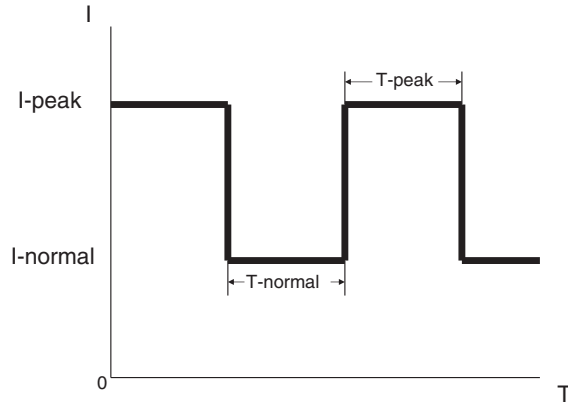

T-peak presents while the unit is working within 110%~150% Rating output power. See curve " B " for the variation in T-peak between output current and holdup time. If T-peak is more than the time setting in curve "B", the output current will drop to the constant current limit (I-normal) that is 105% rating power, meanwhile, I-normal and T-normal will be presenting. See curve "A" for the timing back to I-Peak of T-normal and this Mode can use for easy 2-stage battery charger.

## Peak Load SW2 OFF (Mode2)

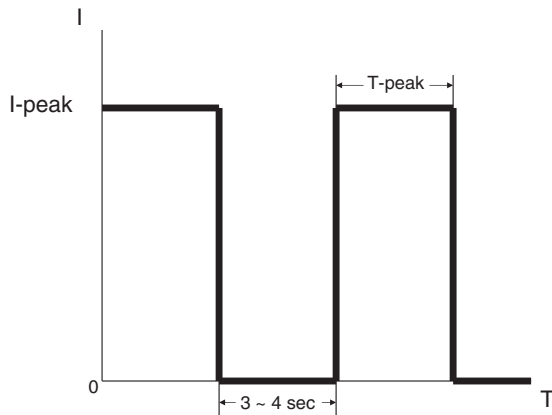

T-peak presents while the unit is working within 110%~150% Rating output power. See curve " B " for the variation in T-peak between output current and holdup time. If T-peak is more than the time setting in curve "B", the output current will be shut down for 3~4 sec, then auto-recovery.

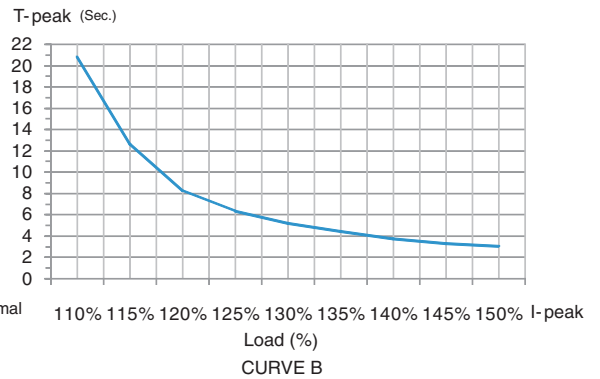
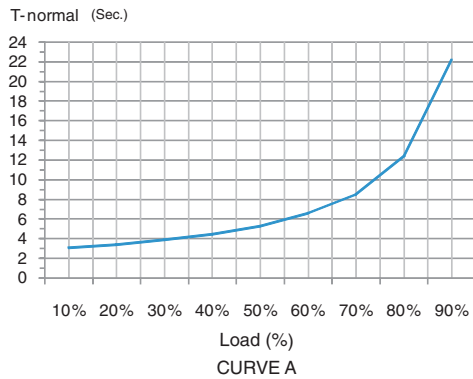

# PSC-481 Series

## Remote ON/OFF

The PSU can be turned ON/OFF by using the "Remote Control" function.

SW2	INH+(3 PIN)/ INH-(4 PIN)	Output Status
OFF	SW ON (>2.5V)	ENABLE
OFF	SW OFF (<0.8V)	DISABLE
ON	SW ON (>2.5V)	DISABLE
ON	SW OFF (<0.8V)	ENABLE

(Default Setting)

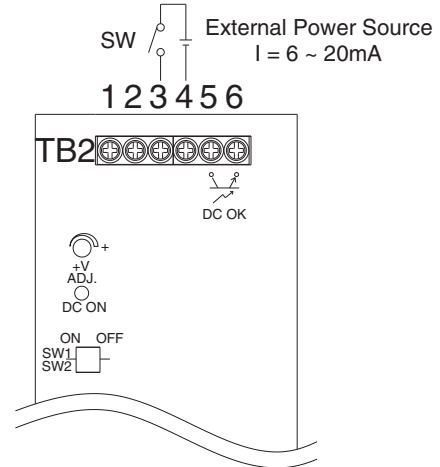

## Derating Curve

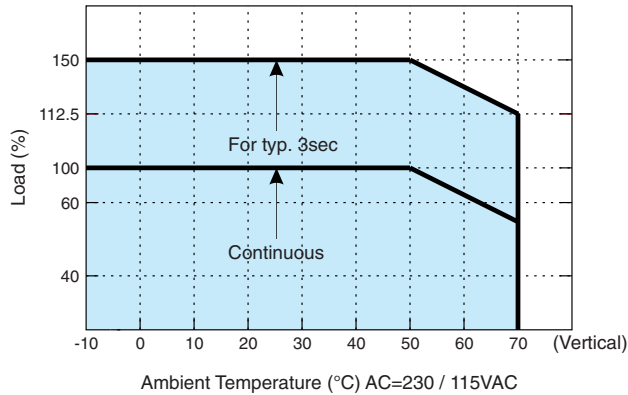

## Output derating VS input Voltage

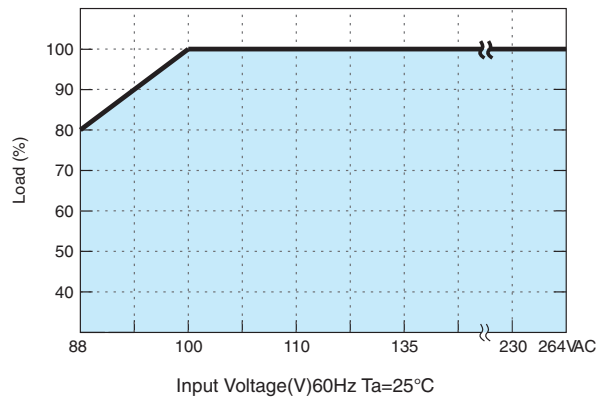



# PSC-RM20 Specifications



### Features:

- Suitable for redundant operation of 24V system
- Installed on DIN Rail TS35 / 7.5 or 15
- Relay contact signal output and LED indicator for input failure alarm
- Cooling by free air convection
- 3 year warranty

## OUTPUT

### Cat. No. PS-RDN20

REVERSE VOLTAGE (max.)	30V
OUTPUT CURRENT (max.)	20A
VOLTAGE DROP	0.5V
LED INDICATORS	Two green LED's indicating each input is OK or fail

## INPUT

INPUT VOLTAGE RANGE	21 ~ 28V
NUMBER OF INPUTS	Two
INPUT CURRENT (max.)	20A per input

## PROTECTION

INPUT VOLTAGE ALARM	When input is $\geq 20V (\pm 5\%)$ or $\leq 30V (\pm 5\%)$ relay contacts
RELAY CONTACT RATING (max.)	30VDC, 1A

## ENVIRONMENT

WORKING TEMP.	-20 ~ +70°C
WORKING HUMIDITY	20 ~ 90% RH non-condensing
STORAGE TEMP., HUMIDITY	-40 ~ +85°C, 10 ~ 95% RH
VIBRATION	10 ~ 500Hz, 2G 10min./1cycle, 60 min. each long X,Y, Z axes
MOUNTING	Compliance to IEC60068-2-6

## SAFETY & EMC

WITHSTAND VOLTAGE	Terminal- Chassis: 0.5KVAC, Relay Contacts- Terminal: 0.5KVAC
ISOLATION RESISTANCE	Terminal- Chassis: $\geq 100M \text{ Ohms} / 500VDC (25^\circ C; 70\% RH)$
EMI CONDUCTION & RADIATION	Compliance to EN55022 (CISPR22) Class B
EMS IMMUNITY	Compliance to EN61000-4-2,3,4,5,6,8; ENV50204; heavy industry level; criteria A,

## OUTPUT

MTBF	996.8Khrs min. MIL-HDBK-217K (25°C)
DIMENSION	55.5x125.2x100mm (WxHxD)
PACKING	0.45Kg; 20pcs / 11Kg / 1.29CUFT

All parameters NOT specially mentioned are measured at 24V DC input, rated load and 25°C of ambient temperature.

### Block Diagram

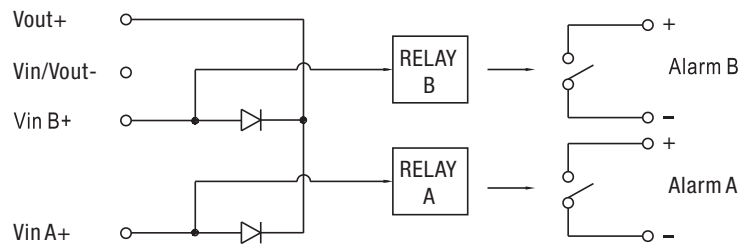

## Mechanical Specification

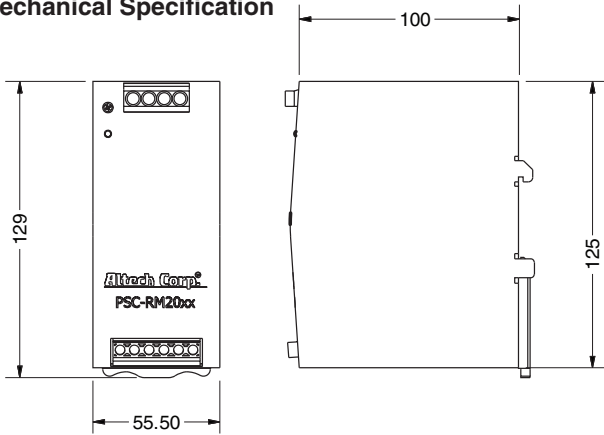

Terminal Pin. No Assignment (TB1)

Pin No.	Assignment
1	Vout+
2	Vout-
3,4	Vin-
5	Vin B+
6	Vin A+

Terminal Pin. No Assignment (TB2)

Pin No.	Assignment
1	Alarm B1
2	Alarm B2
3	Alarm A1
4	Alarm A2

## Applications

### 1. 1+1 Redundancy

Using 1 more PSU as the redundant unit

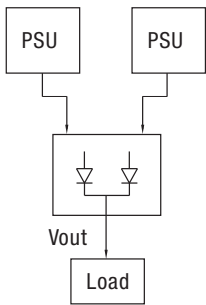

### 2. 1+N Redundancy: Using more PSUs as the redundant units to increase the reliability

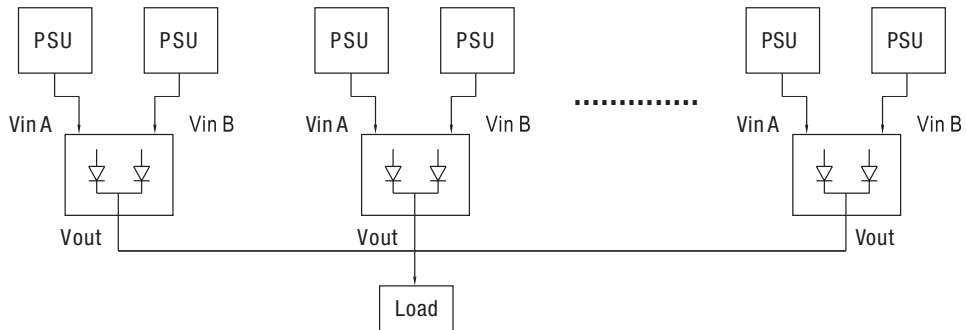

### 3. Single Use: Connecting only one PSU to one PS-RDN20 to reduce the stress of the diodes and hence increase the reliability

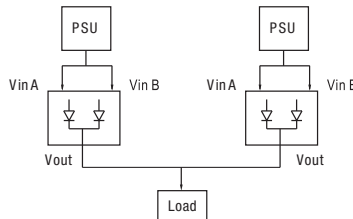

## Derating Curve

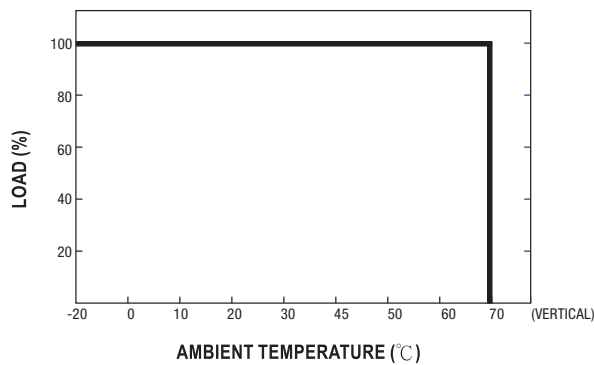

Note: All dimensions are in millimeters, to convert to inches multiply by 0.03937.



# FLEX Power Single Phase 24V DC Power Supplies

## More flexibility in input voltage

The FLEX line of power supplies are suitable to a wide range of input voltage. With a single type it is therefore possible to meet the requirements of more applications and consequently improve design activity and stock management.

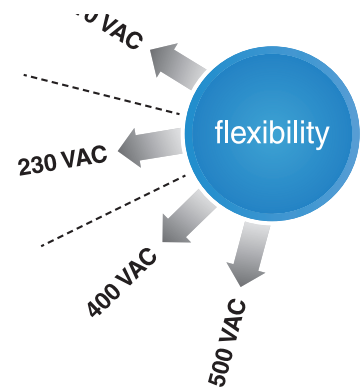

## More Power: *Power Boost*

As an example, PSA-18024 is a 24Vdc power supply that features a continuous duty current of 7.5A at 110°C and 5A at 60°C and a Power Boost of 150%, equivalent to 7.5A, for at least 3 min. This feature allows the use of a smaller size unit to power demanding loads such as motors, solenoid valves, lamps and other loads with transient overload behavior which would otherwise require an oversize power supply.

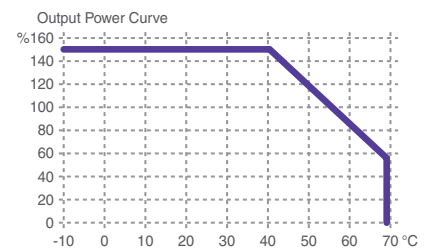

## More flexibility in input voltage

As an example, PSA-18024 can be the right solution for two design cases in very different temperature conditions:

- 1) 7.5A, 24Vdc in continuous duty at 40°C.
- 2) 5A, 24Vdc in continuous duty at 60°C +Power Boost 7,5A for at least 3 min.

## Power Good relay for monitoring the output voltage level

Output voltage is continuously monitored. The units 24 VDC output are equipped with Power Good relay. The NO contact triggers any time the output voltage level goes below 20Vdc (24 Vdc output). This feature is particularly useful in redundant applications.

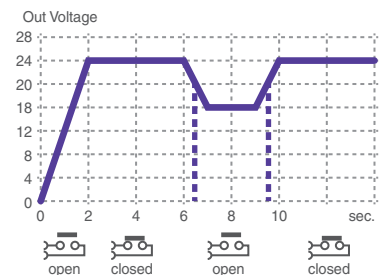

## Applications in compliance with EN 60204-1 standard

The FLEX Power units comply with the requirement of EN60204-1 standard that an overload of 50% over the nominal current be withstand by the power supply for at least 1 hour to allow the tripping of magneto-thermic switches on the output. These features allows the implementation of "Control of commands and Emergency stops" by means of industrial PCs, PLC, remote I/O, etc. required by the standard.



# FLEX Power Single Phase 24V DC Power Supplies

## Hiccup Mode Automatic Restart

This is the default factory setting of all FLEX Power units. In case of shortcircuit or overloading, the output current is interrupted. The device tries again to re-establish output voltage and normal condition about every 2 second till the problem is cleared.

## Manual Reset Mode Restart by Operator

In case of short-circuit or overload, the output current is interrupted. In order to restart the output it is necessary to switch-off the input circuit for about 1 minute. This protection mode is particularly suggested in applications where safety procedures require that reset be carried out only by an authorized person.

## Continuous Output mode

In case of short-circuit or overload, the output current is kept at high values with near zero voltage. In case of short circuit the current can reach up to 3 times the rated current at 60°C. This protection mode is used to meet the requirements of demanding loads such as motors, solenoid valves, lamps, PLC with highly capacitive input circuits and other loads with marked transient overload behavior.

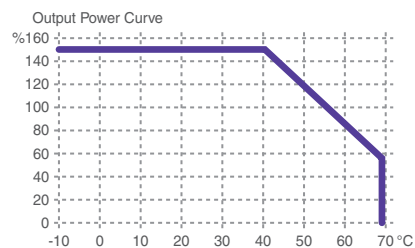
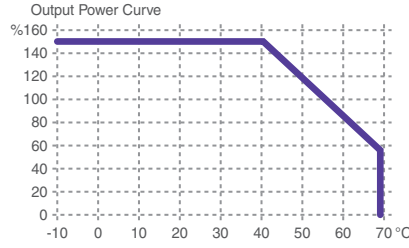
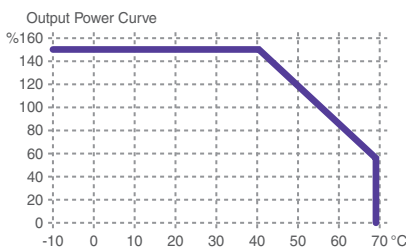

## Jumper settings



HICUP  
MODE



MANUAL  
RESET



CONTINUOUS  
OUT MODE

---

## Output circuits protected by magneto-thermic circuit breakers

Standard output circuit breakers can be triggered quickly and reliably with FLEX technology, which allows three times the nominal current at 60°C. Defective current paths are selectively disconnected, the defect is limited and the important parts of the system remain in operation. This together with the 50% overload capacity in compliance with EN60204-1 allows to safely manage any overload and short circuit condition.

## Reduced dimensions and snap-on DIN rail bracket

The higher performances obtained with the FLEX Power line, allow almost half dimensions as conventional technology and higher performances. An example is the PSA-12024 (120V) with maximum current is 12A. In permanent duty at 40°C it can deliver 5A at 24Vdc. All FLEX units feature the new DIN rail mounting bracket, easy to use and safe against heavy loading and vibrations.

## Easy Parallel connection

With FLEX technology it is easy to double capacity. The units PSA-360, PSB-360, PSA-600 and PSB-600 can be easily connected in parallel without needing high precision instruments. Follow instructions supplied with each unit.

# FLEX Power Single Phase 24V DC Power Supplies

## Specifications



### Features:

- Multiple overload/ short circuit protection modes
- Efficiency above 91%
- Small size
- DIN rail mountable
- Cooling by free air convection
- UL508 (industrial control equipment) approved
- EN60950-1
- Built-in DC OK relay contact
- 3 year warranty



### 120W DIN Rail Power Supply

Cat. No.	Phases	Output V DC A	Tol. %	Ripple & Noise	Efficiency	NOTES
PSA-12024	1	24V DC 5A	±3%	≤80 mVp-p	≥91%	



### 180W DIN Rail Power Supply

Cat. No.	Phases	Output V DC A	Tol. %	Ripple & Noise	Efficiency	NOTES
PSA-18024	1	24V DC 7.5A	±3%	≤80 mVp-p	≥91%	

12V DC and 48V DC output on request.



### 360W DIN Rail Power Supply

Cat. No.	Phases	Output V DC A	Tol. %	Ripple & Noise	Efficiency	NOTES
PSA-36024	1	24V DC 14A	±3%	≤80 mVp-p	≥91%	

12V DC and 48V DC output on request.



### 600W DIN Rail Power Supply

Cat. No.	Phases	Output V DC A	Tol. %	Ripple & Noise	Efficiency	NOTES
PSA-60024	1	24V DC 25A	±3%	≤80 mVp-p	≥92%	

48V DC output on request.

\*\*Other output voltages on request.

# SPECIFICATIONS

## PSA-12024 Series

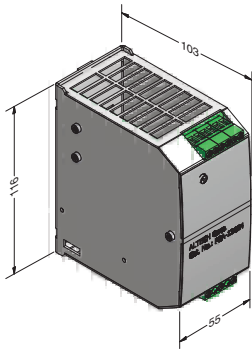

Terminal Pin. No Assignment (TB1)		Terminal Pin. No Assignment (TB2)	
Pin No.	Assignment PSA-12024 (1 phase)	Pin No.	Assignment PSA-12024 (1 phase)
1	N/AC	1/2	DC OUTPUT -V
2	L/AC	3/4	DC OUTPUT +V
3	FG ⊕	5/6	Relay Contact

**Nominal Input Data:** 115VAC/1.8A - 230VAC/0.9A (selectable by switch)

**Connection:** screw terminal blocks for wires 0.2-2.5mm<sup>2</sup> / AWG 24-14

**Size (WxHxD):** 55x116x103 mm (2.17x4.57x4.06 inches)

**Packaging:** 1/box; 0.5kg (1.1 lbs)

## PSA-18024 Series

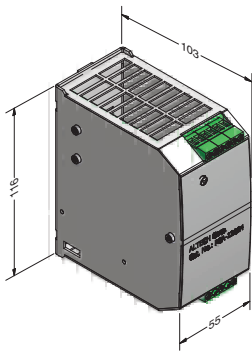

Terminal Pin. No Assignment (TB1)		Terminal Pin. No Assignment (TB2)	
Pin No.	Assignment PSA-18024 (1 phase)	Pin No.	Assignment PSA-18024 (1 phase)
1	N/AC	1/2	DC OUTPUT -V
2	L/AC	3/4	DC OUTPUT +V
3	FG ⊕	5/6	Relay Contact

**Nominal Input Data:** 115VAC/2.8A - 230VAC/1.3A (selectable by switch)

**Connection:** screw terminal blocks for wires 0.2-2.5mm<sup>2</sup> / AWG 24-14

**Size (WxHxD):** 55x116x103 mm (2.17x4.57x4.06 inches)

**Packaging:** 1/box; 0.6kg (1.32 lbs)

## PSA-36024 Series

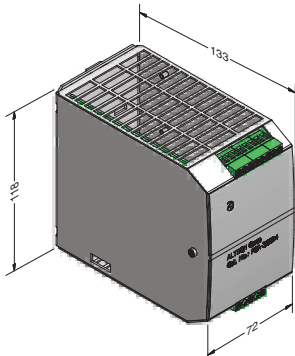

Terminal Pin. No Assignment (TB1)		Terminal Pin. No Assignment (TB2)	
Pin No.	Assignment PSA-36024 (1 phase)	Pin No.	Assignment PSA-36024 (1 phase)
1	N/AC	1/2/3	DC OUTPUT -V
2	L/AC	4/5/6	DC OUTPUT +V
3	FG ⊕	7/8	Relay Contact

**Nominal Input Data:** 115VAC/3.3A - 230VAC/2.2A (selectable by switch)

**Connection:** screw terminal blocks for wires 0.2-2.5mm<sup>2</sup> / AWG 24-14

**Size (WxHxD):** 72x116x133 mm (2.83x4.49x5.24 inches)

**Packaging:** 1/box; 0.72kg (1.59 lbs)

## PSA-60024 Series

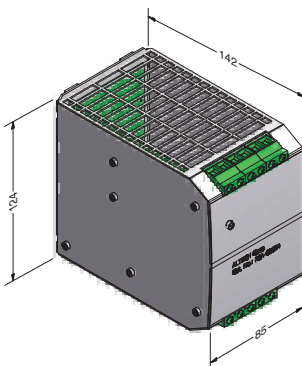

Terminal Pin. No Assignment (TB1)		Terminal Pin. No Assignment (TB2)	
Pin No.	Assignment PSA-60024 (1 phase)	Pin No.	Assignment PSA-60024 (1 phase)
1	N/AC	1/2	DC OUTPUT -V
2	L/AC	3/4	DC OUTPUT +V
3	Jumper 115V AC	5/6	Relay Contact
4	Jumper 115V AC		
5	FG ⊕		

**Nominal Input Data:** 115VAC/8.0A - 230VAC/4.2A (selectable by switch)

**Connection:** screw terminal blocks for wires up to 4mm<sup>2</sup> / 11AWG (solid), 6mm<sup>2</sup> / 10AWG (stranded)

**Size (WxHxD):** 85x120x142 mm (3.35x4.72x5.59 inches)

**Packaging:** 1/box; 1.0kg (2.2 lbs)



# PSA-120 Series (1 Phase) Specifications

## Features:

- Multiple overload/ short circuit protection modes
- Efficiency above 91%
- Small size
- DIN rail mountable
- Cooling by free air convection
- UL 508 (industrial control equipment) approved
- EN60950-1
- Built-in DC OK relay circuit
- 3 year warranty



## OUTPUT

### Cat. No. PSA-12024

DC VOLTAGE	24 V
RATED CURRENT	5A
CURRENT RANGE	0-5A
RATED POWER	120 W
RIPPLE & NOISE (max)	100 mVp-p Ripple & noise are measured at 20MHz of bandwidth by using a 12" twisted pair-wire terminated with a 0.1µF & 47µF parallel capacitor.
VOLTAGE ADJ. RANGE	22 V ~ 27 V
VOLTAGE TOLERANCE	-0.3% Tolerance: includes set up tolerance, line regulation and load regulation.
START UP WITH STRONG LOAD	≤ 50,000 µF
SHORT CIRCUIT CURRENT I <sub>cc</sub>	12A Max 2 sec.: Hiccup mode Permanent: Continuous mode
DISSIPATION POWER LOAD max	11 W
LINE REGULATION	± 0.5%
LOAD REGULATION	± 1%
SETUP, RISE TIME	1 sec. (max) Length of set up time is measured at cold first start. Turning ON/OFF the power supply may lead to increase of the set up time.
HOLD UP TIME (Typ.)	20 msec

## INPUT

VOLTAGE RANGE	90 ~ 135V AC / 180 ~ 264V AC switch select
FREQUENCY RANGE	47 ~ 63 Hz
EFFICIENCY (Typ.)	>91 %
AC CURRENT (115 - 230V)	1.8 - 0.9V AC
INRUSH CURRENT (Typ.)	< 11 A ≤ 5 msec
INTERNAL FUSE	4A (T)
EXTERNAL FUSE (recommended)	10 A (MCB curve B)
LEAKAGE CURRENT	< 1.5 mA @ 230 V AC

## PROTECTION

OVERLOAD	In (60°C) x 1.5 <sup>3</sup> ≥ 3 min. Current max. Overload @ 4VDC (permanent) I <sub>max</sub> =In (60°C) x (1.8 - 2.2)
OVER VOLTAGE	30 ~ 35 VDC
OVER TEMPERATURE	Shuts down output and automatically restarts when the temperature inside goes down
SHORT CIRCUIT PROTECTION	1 Hiccup Mode / 2 Fold Back / 3 Restart After Main - Selectable

## ENVIRONMENT

WORKING TEMP.	-25 up to +70 °C
HUMIDITY	95 % at 25°C, no condensation
STORAGE TEMP.	-40 up to +85 °C
TEMP. COEFFICIENT	± 0.03% / C° (0 ~ 60 °C)
MOUNTING	In according to IEC60068-2-6

## SAFETY & EMC

SAFETY STANDARDS	UL508 Listed, IEC/EN 60950, EN 50178, IEC/EN 60950, EN60950-1, PELV EN 60204-1
WITHSTAND VOLTAGE	I/P-O/P: 3k VAC I/P-FG: 1.6k VAC O/P-FG: 500 VAC
PROTECTION CLASS	IP 20 (EN/IEC 60529)
ISOLATION RESISTANCE	100 MΩ (min) @ 500 VDC
EMI CONDUCTION & RADIATION	EN61000-6-4
HARMONIC CURRENT	EN61000-3-2
EMS IMMUNITY	EN 61000-4-2, EN 61000-4-3, EN 61000-4-4, EN 61000-4-5, EN 61000-4-6, EN61000-6-2, The power supply is considered a component which will be installed into a final equipment. The final equipment must be re-confirmed that it still meets EMC directives.

## OTHERS

MTBF IEC 61709	> 500,000 h
DC OK AKTIV SIGNAL (max.)	20 ~ 30 VDC
POLLUTION DEGREE	2
CONNECTION TERMINAL BLOCK	2.5 mm Screw terminal (24 ~ 14 AWG)
DIMENSION	55x110x105 mm ( 2.16x4.33x4.13 in )
PACKING	0.50 kg ( 1.1 lbs) each

All parameters NOT specially mentioned are measured at 230V AC input, rated load and 25°C of ambient temperature.

## Mechanical Specification

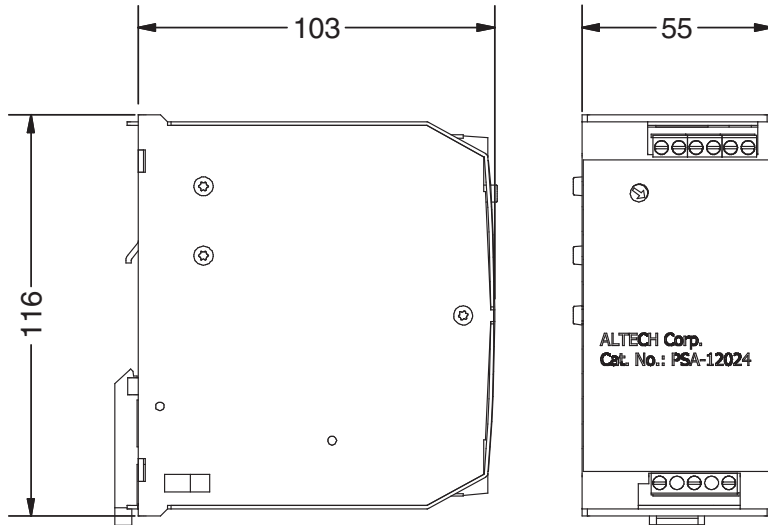

TB1 Terminal Pin. No Assignment

Pin No.	Assignment (1 phase)
1	N / AC
2	L / AC
2	FG Ⓧ

TB2 Terminal Pin. No Assignment

Pin No.	Assignment
1,2	DC output -V
3,4	DC output +V
5,6	DC OK relay contacts

## DC OK Relay Contact

Outputs are used for preventive function monitoring of the power supply. An electrically isolated signal contact is available. The signal contact closes when the output power is OK and opens when the output voltage falls below 20Vdc  $\pm$ 5%.

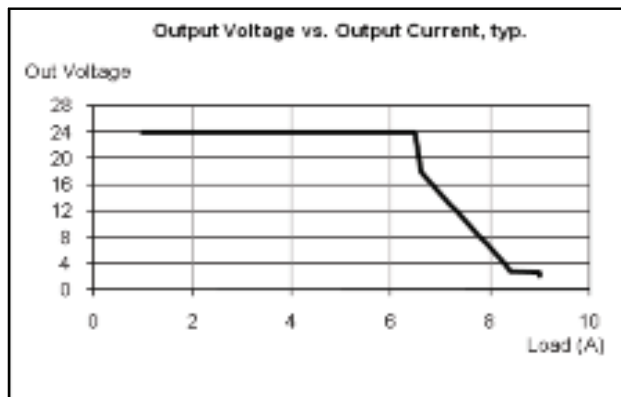

## Output Derating Curve

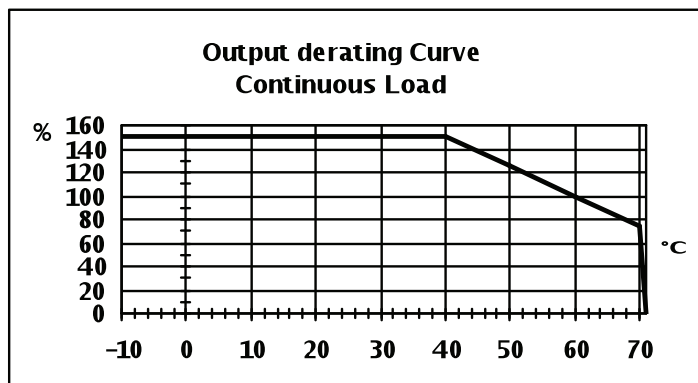

Note: All dimensions are in millimeters, to convert to inches multiply by 0.03937.





# PSA-180 Series (1 Phase)

## Specifications



### Features:

- Multiple overload/ short circuit protection modes
- Efficiency above 91%
- Small size
- DIN rail mountable
- Cooling by free air convection
- UL508 (industrial control equipment) approved
- EN60950-1
- Built-in DC OK relay contact
- 3 year warranty

### OUTPUT

Cat. No.	PSA-18024
DC VOLTAGE	24 V
RATED CURRENT	7.5 A
CURRENT RANGE	0-7.5A
RATED POWER	180 W
RIPPLE & NOISE (max)	100 mVp-p
VOLTAGE ADJ. RANGE (DC)	10 V ~ 14 V
VOLTAGE TOLERANCE	-0.03
START UP WITH STRONG LOAD	≤ 50,000 μF
SHORT CIRCUIT CURRENT I <sub>cc</sub>	16 A Max 2 sec.: Hiccup mode Permanent: Continuous mode
DISSIPATION POWER LOAD mas	17 W
LINE REGULATION	± 0.5%
LOAD REGULATION	± 1%
SETUP, RISE TIME	1 sec. (max)
HOLD UP TIME (Typ.)	Length of set up time is measured at cold first start. Turning ON/OFF the power supply may lead to increase of the set up time. Typ. 20 msec

### INPUT

VOLTAGE RANGE	90 ~ 135V AC / 180 ~ 264V AC switch select
FREQUENCY RANGE	47 ~ 63 Hz +-6%
EFFICIENCY (Typ.)	>91 %
AC CURRENT (115 – 230 Vac.)	2.8 ~ 1.3 A
INRUSH CURRENT (Typ.)	< 11 A < 5 msec
INTERNAL FUSE	4A (T)
EXTERNAL FUSE (recommended)	10 A (MCB curve B)
LEAKAGE CURRENT	< 1.5 mA @ 230 Vac

### PROTECTION

OVERLOAD	In (60°C) x 1.5 <sup>3</sup> (3 min.) Current max. Overload @ 4Vdc (permanent) I <sub>max</sub> =In (60°C) x (1.8 - 2.2)
OVER VOLTAGE	30 – 35 Vdc
OVER TEMPERATURE	Yes. Shuts down output and automatically restarts when the temperature inside goes down
SHORT CIRCUIT PROTECTION	1 Hiccup Mode / 2 Fold Back / 3 Restart After Main - Selectable

### ENVIRONMENT

DC OK AKTIV SIGNAL (max.)	20 ~ 30 Vdc
WORKING TEMP.	-25 up to +70 °C
HUMIDITY	95 % at 25°C, no condensation
STORAGE TEMP	-40 up to +85 °C
TEMP. COEFFICIENT	± 0.03% / C° (0 ~ 60 °C)
MOUNTING	In according to IEC60068-2-6

### SAFETY & EMC

SAFETY STANDARDS	UL508 Listed IEC/EN 60950, EN 50178, IEC/EN 60950, EN60950-1, PELV EN 60204-1
WITHSTAND VOLTAGE	I/P-O/P: 3k VAC I/P-FG: 1.6k VAC O/P-FG: 500 VAC
PROTECTION CLASS	IP 20 (EN/IEC 60529)
ISOLATION RESISTANCE	100 MΩ (min) @ 500 Vdc
EMI CONDUCTION & RADIATION	EN61000-6-4
HARMONIC CURRENT	EN61000-3-2
EMS IMMUNITY	EN 61000-4-2, EN 61000-4-3, EN 61000-4-4, EN 61000-4-5, EN 61000-4-6, EN61000-6-2, EN61000-6-4, The power supply is considered a component which will be installed into a final equipment. The final equipment must be re-confirmed that it still meets EMC directives.

### OTHERS

MTBF IEC 61709	> 500.000 h
POLLUTION DEGREE	2
CONNECTION TERMINAL BLOCK	2.5 mm Screw terminal (24 ~ 14 AWG)
DIMENSION	55x110x105 mm ( 2.16x4.33x4.13 in )
PACKING	0.60 kg ( 1.3 lbs) each
NOTE	All parameters NOT specially mentioned are measured at 230V AC input, rated load and 25°C of ambient temperature.

## Mechanical Specification

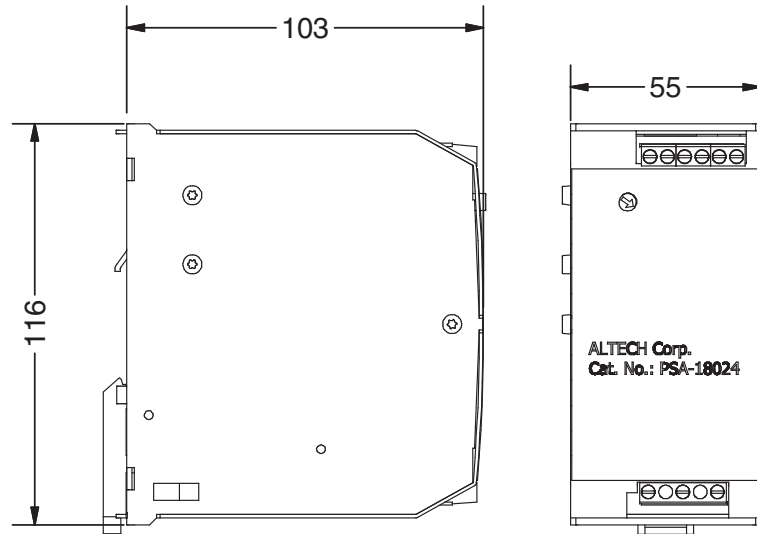

TB1 Terminal Pin. No Assignment

Pin No.	Assignment (1 phase)
1	N / AC
2	L / AC
3	FG ⊕

TB1 Terminal Pin. No Assignment

Pin No.	Assignment
1,2	DC output -V
3,4	DC output +V
5,6	DC OK relay contacts

## DC OK Relay Contact

Outputs are used for preventive function monitoring of the power supply. An electrically isolated signal contact is available. The signal contact closes when the output power is OK and opens when the output voltage falls below 20Vdc  $\pm$ 5%.

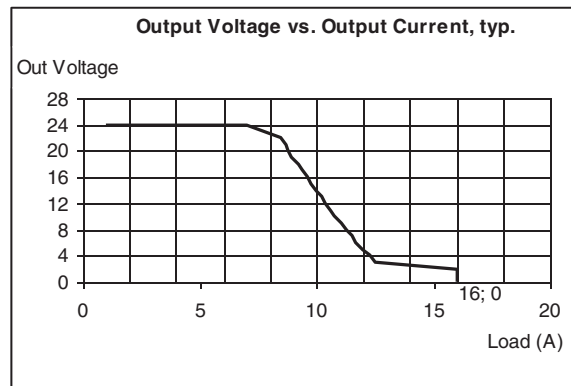

## Output Derating Curve

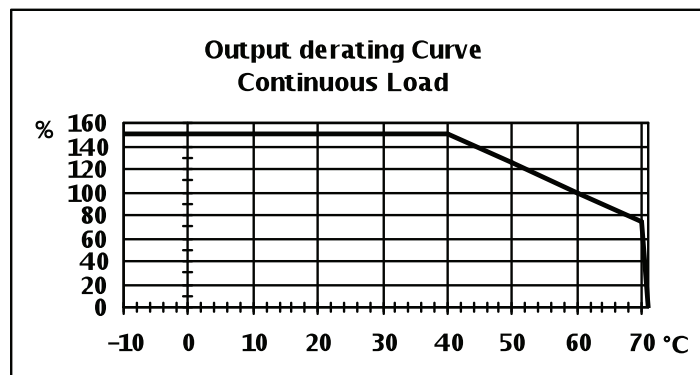

*Note: All dimensions are in millimeters, to convert to inches multiply by 0.03937.*



# PSA-360 Series (1 Phase) Specifications



## Features:

- Multiple overload/ short circuit protection modes
- Efficiency above 91%
- **Easy parallel connection for more power**
- Small size
- DIN rail mountable
- Cooling by free air convection
- UL508 (industrial control equipment) approved
- EN60950-1
- Built-in DC OK relay contact
- 3 year warranty

## OUTPUT

Cat. No.	PSA-36024
DC VOLTAGE	24 V
RATED CURRENT	14 A
CURRENT RANGE	0 ~ 14 A
RATED POWER	336 W
RIPPLE & NOISE (max)	80 mVp-p
VOLTAGE ADJ. RANGE (DC)	22 ~ 27 V
VOLTAGE TOLERANCE	-0.03
START UP WITH STRONG LOAD	≤ 50,000 μF
SHORT CIRCUIT CURRENT I <sub>cc</sub>	30 A
DISSIPATION POWER LOAD P <sub>max</sub>	28 W
LINE REGULATION	± 0.5%
LOAD REGULATION	± 1%
SETUP, RISE TIME	1 sec. (max)
HOLD UP TIME (Typ.)	Typ. 20 msec
VOLTAGE RANGE	90 ~ 135V AC / 180 ~ 264V AC switch select

Ripple & noise are measured at 20MHz of bandwidth by using a 12" twisted pair-wire terminated with a 0.1μF & 47μF parallel capacitor.  
Tolerance: includes set up tolerance, line regulation and load regulation.  
Length of set up time is measured at cold first start. Turning ON/OFF the power supply may lead to increase of the set up time.

## INPUT

FREQUENCY RANGE	47 ~ 63 Hz
EFFICIENCY (Typ.)	>91 %
AC CURRENT (115 – 230 Vac.)	3.3 ~ 2.2 A
INRUSH CURRENT (Typ.)	< 16 A < 5 msec
INTERNAL FUSE	6.3 A (T)
EXTERNAL FUSE (recommended)	16 A (MCB curve B)
LEAKAGE CURRENT	< 1.5 mA @ 230 Vac

## PROTECTION

OVERLOAD	I <sub>n</sub> (60°C) x 1.5 <sup>3</sup> (3 min.)
OVER VOLTAGE	Current max. Overload @ 4Vdc (permanent) I <sub>max</sub> =I <sub>n</sub> (60°C) x (1.8 - 2.2)
OVER TEMPERATURE	14 ~ 17 Vdc                      30 ~ 35 Vdc                      50 ~ 55 Vdc
SHORT CIRCUIT PROTECTION	Yes. Shuts down output and automatically restarts when the temperature inside goes down 1 Hiccup Mode / 2 Fold Back / 3 Restart After Main - Selectable

## ENVIRONMENT

DC OK AKTIV SIGNAL (max.)	20 ~ 30 Vdc
WORKING TEMP.	-25 up to +70 °C
HUMIDITY	(>60°derating 2.5% °C)
STORAGE TEMP	95 % at 25°C, no condensation
TEMP. COEFFICIENT	-40 up to +85 °C
MOUNTING	± 0.03% / °C (0 ~ 60 °C)
	I <sub>n</sub> according to IEC60068-2-6

## SAFETY & EMC

SAFETY STANDARDS	UL508 Listed IEC/EN 60950, EN 50178, IEC/EN 60950, EN60950-1, PELV EN 60204-1
WITHSTAND VOLTAGE	I/P-O/P: 3k VAC    I/P-FG: 1.6k VAC    O/P-FG: 500 VAC
PROTECTION CLASS	IP 20 (EN/IEC 60529)
ISOLATION RESISTANCE	100 MΩ (min) @ 500 Vdc
EMI CONDUCTION & RADIATION	EN61000-6-4
HARMONIC CURRENT	
EMS IMMUNITY	EN 61000-4-2, EN 61000-4-3, EN 61000-4-4, EN 61000-4-5, EN 61000-4-6, EN61000-6-2, EN61000-6-4,
	The power supply is considered a component which will be installed into a final equipment. The final equipment must be re-confirmed that it still meets EMC directives.

## OTHERS

MTBF IEC 61709	> 500.000 h
POLLUTION DEGREE	2
CONNECTION TERMINAL BLOCK	2.5 mm Screw terminal (24 ~ 14 AWG)
DIMENSION	72x115x135 mm ( 2.8x4.5x5.3 in )
PACKING	0.65 kg ( 1.4 lbs) each
NOTE	All parameters NOT specially mentioned are measured at 230V AC input, rated load and 25°C of ambient temperature.

## Mechanical Specification

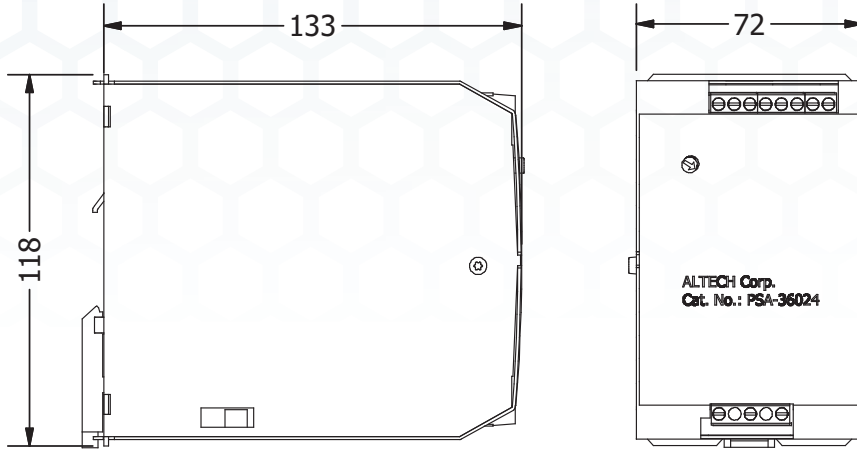

TB1 Terminal Pin. No Assignment

Pin No.	Assignment (1 phase)
1	N
2	L
	FG ⊕

TB1 Terminal Pin. No Assignment

Pin No.	Assignment
1,2,3	DC output -V
4,5,6	DC output +V
7,8	DC OK relay contacts

## DC OK Relay Contact

Outputs are used for preventive function monitoring of the power supply. An electrically isolated signal contact is available. The signal contact closes when the output power is OK and opens when the output voltage falls below 20Vdc ±5%.

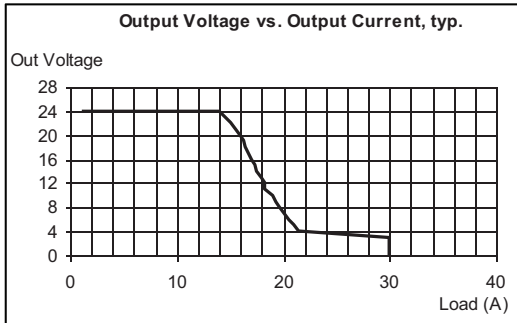

## Output Derating Curve

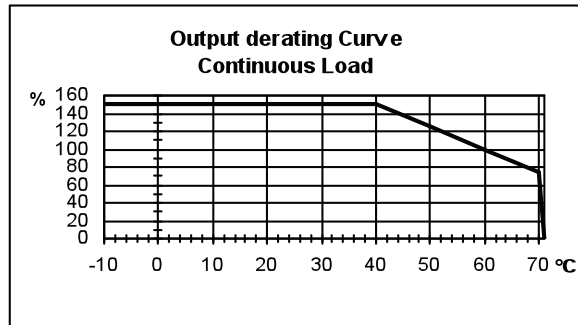

## Parallel Connection

A parallel connection with the same model power supply can be set up to increase the output power. The output has to be adjusted approximately to the same value (± 20mV) while applying a 1-2 A load to all devices before connecting them in parallel. In PSA-360xx, for more power, the position of the Easy Parallel jumper needs to be changed to enable a parallel connection. In this mode up to 4 power supplies can be put together in parallel.

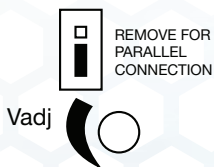
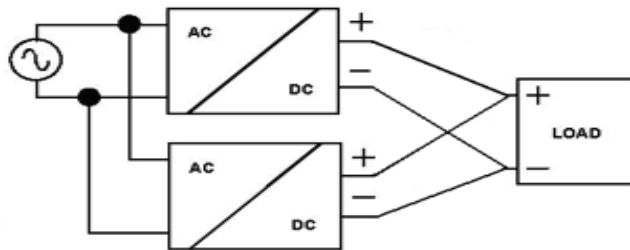

Easy Parallel connection  
OFF (factory selection)

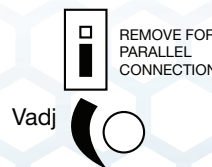

Easy Parallel  
ON

Note: All dimensions are in millimeters, to convert to inches multiply by 0.03937.



# PSA-600 Series (1 Phase)

## Specifications



### Features:

- Multiple overload/ short circuit protection modes
- Efficiency above 92%
- **Easy parallel connection for more power**
- Small size
- DIN rail mountable
- Cooling by free air convection
- UL508 (industrial control equipment) approved
- EN60950-1
- Built-in DC OK relay contact
- 3 year warranty

### OUTPUT

#### Cat. No. PSA-60024

DC VOLTAGE	24 V
RATED CURRENT	25 A
CURRENT RANGE	0-25A
RATED POWER	600 W
RIPPLE & NOISE (max)	100 mVp-p
Ripple & noise are measured at 20MHz of bandwidth by using a 12" twisted pair-wire terminated with a 0.1µF & 47µF parallel capacitor.	
VOLTAGE ADJ. RANGE	22 V ~ 27 V
VOLTAGE TOLERANCE	-0.03
Tolerance: includes set up tolerance, line regulation and load regulation.	
START UP WITH STRONG LOAD	≤ 50,000 µF
SHORT CIRCUIT CURRENT I <sub>cc</sub>	60 A
Max 2 sec.: Hiccup mode	
Permanent: Continuous mode	
DISSIPATION POWER LOAD mas	54 W
LINE REGULATION	± 0.5%
LOAD REGULATION	± 1%
SETUP, RISE TIME	1 sec. (max)
Length of set up time is measured at cold first start. Turning ON/OFF the power supply may lead to increase of the set up time.	
HOLD UP TIME (Typ.)	Typ. 20 msec

### INPUT

VOLTAGE RANGE	90 ~ 135V AC / 180 ~ 264V AC switch select
FREQUENCY RANGE	47 ~ 63 Hz +-6%
EFFICIENCY (Typ.)	>91 %
AC CURRENT (115 – 230 Vac.)	8 ~ 4.2 A
INRUSH CURRENT (Typ.)	< 16 A < 5 msec
INTERNAL FUSE	10A (T)
EXTERNAL FUSE (recommended)	16 A (curve B)
LEAKAGE CURRENT	< 1.5 mA @ 230 Vac

### PROTECTION

OVERLOAD	In (60°C) x 1.5 <sup>3</sup> (3 min.) Current max. Overload @ 4Vdc (permanent) I <sub>max</sub> =In (60°C) x (1.8 - 2.2)
OVER VOLTAGE	30 ~ 35 Vdc
OVER TEMPERATURE	Yes. Shuts down output and automatically restarts when the temperature inside goes down
SHORT CIRCUIT PROTECTION	1 Hiccup Mode / 2 Fold Back / 3 Restart After Main - Selectable

### ENVIRONMENT

DC OK AKTIV SIGNAL (max.)	20 ~ 30 Vdc
WORKING TEMP.	-25 up to +70 °C
HUMIDITY	95 % at 25°C, no condensation
STORAGE TEMP	-40 up to +85 °C
TEMP. COEFFICIENT	± 0.03% / C° (0 ~ 60 °C)
MOUNTING	In according to IEC60068-2-6

### SAFETY & EMC

SAFETY STANDARDS	UL508 Listed IEC/EN 60950, EN 50178, IEC/EN 60950, EN60950-1, PELV EN 60204-1
WITHSTAND VOLTAGE	I/P-O/P: 3k VAC I/P-FG: 1.6k VAC O/P-FG: 500 VAC
PROTECTION CLASS	IP 20 (EN/IEC 60529)
ISOLATION RESISTANCE	100 MΩ (min) @ 500 Vdc
EMI CONDUCTION & RADIATION	EN61000-6-4
HARMONIC CURRENT	
EMS IMMUNITY	EN 61000-4-2, EN 61000-4-3, EN 61000-4-4, EN 61000-4-5, EN 61000-4-6, EN61000-6-2, EN61000-6-4,

The power supply is considered a component which will be installed into a final equipment. The final equipment must be re-confirmed that it still meets EMC directives.

### OTHERS

MTBF IEC 61709	> 500.000 h
POLLUTION DEGREE	2
CONNECTION TERMINAL BLOCK	4 mm Screw terminal (30 ~ 10 AWG)
DIMENSION	85x120x140 mm ( 3.34x4.72x5.51 in )
PACKING	0.75 kg (1.9 lbs) each
NOTE	All parameters NOT specially mentioned are measured at 230V AC input, rated load and 25°C of ambient temperature.



## Mechanical Specification

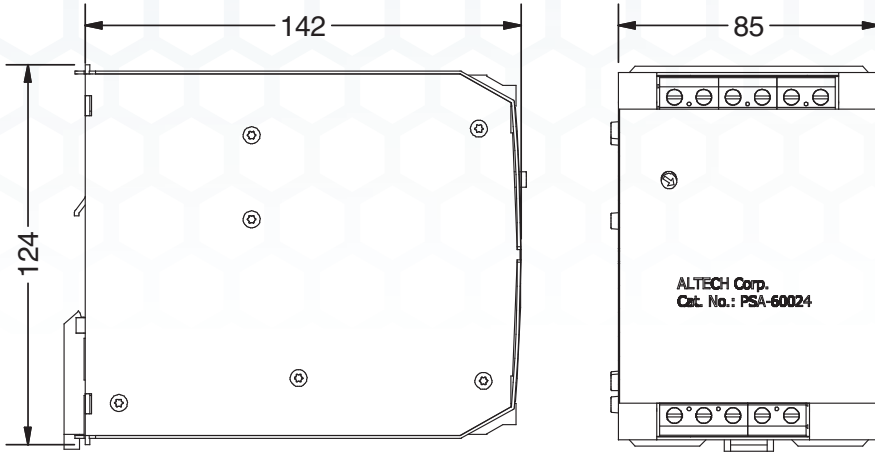

TB1 Terminal Pin. No Assignment

Pin No.	Assignment (1 phase)
1	N / AC
2	L / AC
3	Jumper 115V AC
4	Jumper 115V AC
5	FG

TB2 Terminal Pin. No Assignment

Pin No.	Assignment
1,2	DC output -V
3,4	DC output +V
5,6	DC OK relay contacts

### DC OK Relay Contact

Outputs are used for preventive function monitoring of the power supply. An electrically isolated signal contact is available. The signal contact closes when the output power is OK and opens when the output voltage falls below 20Vdc  $\pm$ 5%.

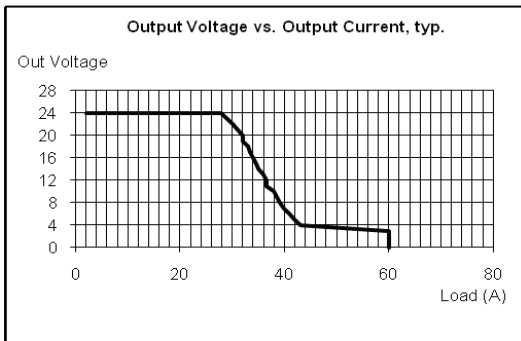

### Output Derating Curve

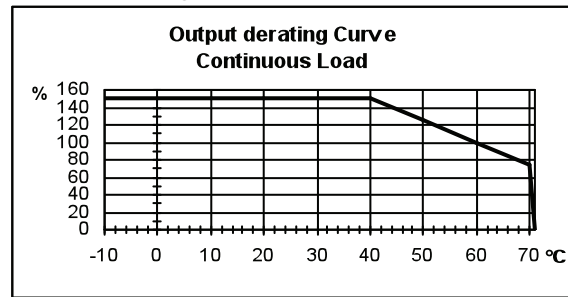

### Parallel Connection

A parallel connection with the same model power supply can be set up to increase the output power. The output has to be adjusted approximately to the same value ( $\pm$  20mV) while applying a 1-2 A load to all devices before connecting them in parallel. In PSA-600xx, for more power, the position of the Easy Parallel jumper needs to be changed to enable a parallel connection. In this mode up to 4 power supplies can be put together in parallel.

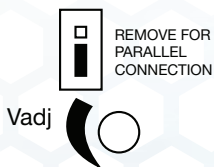
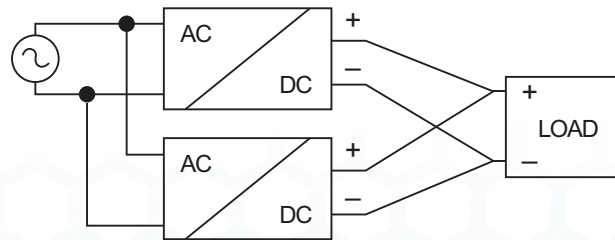

Easy Parallel connection  
OFF (factory selection)

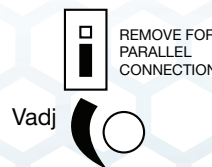

Easy Parallel  
ON

Note: All dimensions are in millimeters, to convert to inches multiply by 0.03937.

# FLEX Power Two and Three Phase 24V DC\*\* Power Supplies

## Specifications



### Features:

- Multiple overload/ short circuit protection modes
- Efficiency above 91%
- Small size
- DIN rail mountable
- Cooling by free air convection
- UL508 (industrial control equipment) approved
- EN60950-1
- Built-in DC OK relay contact
- 3 year warranty



### 120W DIN Rail Power Supply

Cat. No.	Phases	Output V DC A	Tol. %	Ripple & Noise	Efficiency	NOTES
PSB-12024	2	24V DC 5A	±3%	≤80 mVp-p	≥91%	



### 180W DIN Rail Power Supply

Cat. No.	Phases	Output V DC A	Tol. %	Ripple & Noise	Efficiency	NOTES
PSB-18024	2	24V DC 7.5A	±3%	≤80 mVp-p	≥91%	

12 VDC and 48 VDC output on request



### 360W DIN Rail Power Supply

Cat. No.	Phases	Output V DC A	Tol. %	Ripple & Noise	Efficiency	NOTES
PSB-36024	2	24V DC 14A	±3%	≤80 mVp-p	≥91%	

12 VDC and 48 VDC output on request



### 600W DIN Rail Power Supply

Cat. No.	Phases	Output V DC A	Tol. %	Ripple & Noise	Efficiency	NOTES
PSB-60024	3	24V DC 25A	±3%	≤80 mVp-p	≥92%	

48 VDC output on request

\*\*Other output voltages on request.

# SPECIFICATIONS

## PSB-12024 Series

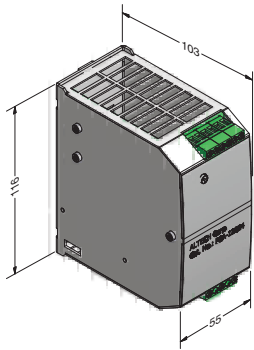

TB1 Terminal Pin. No Assignment

Pin No.	Assignment (2 phase)
1	N / L
2	L / L
3	FG ⊕

TB2 Terminal Pin. No Assignment

Pin No.	Assignment
1,2	DC output -V
3,4	DC output +V
5,6	DC OK relay contacts

**Nominal Input Data:** 230VAC/1.0A - 400VAC/0.5A - 500VAC/0.4A  
(selectable by switch)

**Connection:** screw terminal blocks for 0.2-2.5mm<sup>2</sup> / AWG 24-14 wires.

**Size (WxHxD):** 55x116x103 mm (2.17x4.57x4.06 inches)

**Packaging:** 1/box; 0.5kg (1.1 lbs)

## PSB-18024 Series

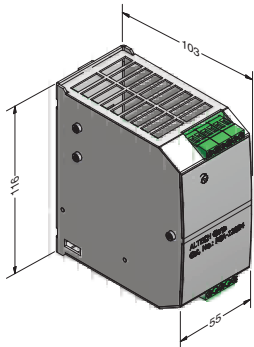

TB1 Terminal Pin. No Assignment

Pin No.	Assignment (2 phase)
1	N / L
2	L / L
3	FG ⊕

TB2 Terminal Pin. No Assignment

Pin No.	Assignment
1,2	DC output -V
3,4	DC output +V
5,6	DC OK relay contacts

**Nominal Input Data:** 230VAC/1.5A - 400VAC/0.8A - 500VAC/0.7A  
(selectable by switch)

**Connection:** screw terminal blocks for 0.2-2.5mm<sup>2</sup> / AWG 24-14 wires.

**Size (WxHxD):** 55x116x103 mm (2.17x4.57x4.06 inches)

**Packaging:** 1/box; 0.6kg (1.32 lbs)

## PSB-36024 Series

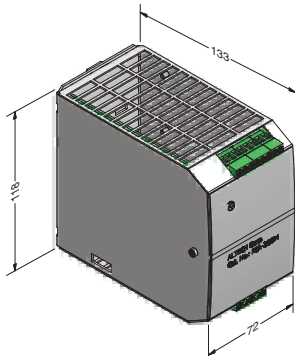

TB1 Terminal Pin. No Assignment

Pin No.	Assignment (2 phase)
1	N/L
2	L/L
3	FG ⊕

TB2 Terminal Pin. No Assignment

Pin No.	Assignment
1,2,3	DC output -V
4,5,6	DC output +V
7,8	DC OK relay contacts

**Nominal Input Data:** 230VAC/2.2A - 400VAC/1.4A - 500VAC/1.0A  
(selectable by switch)

**Connection:** screw terminal blocks for 0.2-2.5mm<sup>2</sup> / AWG 24-14 wires.

**Size (WxHxD):** 72x116x133 mm (2.83x4.49x5.24 inches)

**Packaging:** 1/box; 0.72kg (1.59 lbs)

## PSB-60024 Series

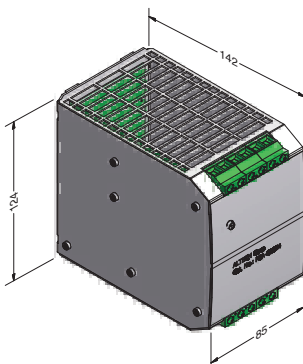

TB1 Terminal Pin. No Assignment

Pin No.	Assignment (3 phase)
1	L1
2	L2
3	L3
4	FG ⊕
5	FG ⊕

TB2 Terminal Pin. No Assignment

Pin No.	Assignment
1,2	DC output -V
3,4	DC output +V
5,6	DC OK relay contacts

**Nominal Input Data:** 400VAC/0.95A - 500VAC/0.85A

**Connection:** screw terminal blocks for wires up to 4mm<sup>2</sup> / 11AWG (solid), 6mm<sup>2</sup> / 10AWG (stranded)

**Size (WxHxD):** 85x120x142 mm (3.35x4.72x5.59 inches)

**Packaging:** 1/box; 1.1kg (2.43 lbs)



# PSB-120 Series (2 Phase) Specifications



## Features:

- Multiple overload/ short circuit protection modes
- Efficiency above 91%
- Small size
- DIN rail mountable
- Cooling by free air convection
- UL508 (industrial control equipment) approved
- EN60950-1
- Built-in DC OK relay contact
- 3 year warranty

## OUTPUT

Cat. No.	PSB-12024
DC VOLTAGE	24 V
RATED CURRENT	5A
CURRENT RANGE	0 - 5 A
RATED POWER	120 W
RIPPLE & NOISE (max)	100 mVp-p
VOLTAGE ADJ. RANGE	22 V ~ 27 V
VOLTAGE TOLERANCE	-0.03
START UP WITH STRONG LOAD	≤ 50,000 μF
CURRENT SHORT CIRCUIT I <sub>cc</sub>	12A
DISSIPATION POWER LOAD max	11 W
LINE REGULATION	± 0.5%
LOAD REGULATION	± 1%
SETUP, RISE TIME	1 sec. (max)
HOLD UP TIME (Typ.)	Typ. 20 msec

Ripple & noise are measured at 20MHz of bandwidth by using a 12" twisted pair-wire terminated with a 0.1μF & 47μF parallel capacitor.

Tolerance: includes set up tolerance, line regulation and load regulation.

Length of set up time is measured at cold first start. Turning ON/OFF the power supply may lead to increase of the set up time.

## INPUT

VOLTAGE RANGE	187 ~ 264 V AC / 330 ~ 550V AC by switch
FREQUENCY RANGE	47 ~ 63 Hz +-6%
EFFICIENCY (Typ.)	>91 %
AC CURRENT (115 – 230 Vac.)	1.0 ~ 0.58 ~ 0.46A
INRUSH CURRENT (Typ.)	< 11 A < 5 msec
INTERNAL FUSE	T 4 A
EXTERNAL FUSE (recommended)	10 A (MCB curve B)
LEAKAGE CURRENT	< 1.5 mA @ 230 Vac

## PROTECTION

OVERLOAD	In (60°C) x 1.5 <sup>3</sup> 3 min.; Current max. Overload @ 4Vdc (permanent) I <sub>max</sub> =In (60°C) x (1.8 ~ 2.2)
OVER VOLTAGE	30 – 35 Vdc
OVER TEMPERATURE	Yes. Shuts down output and automatically restarts when the temperature inside goes down
SHORT CIRCUIT PROTECTION	1 Hiccup Mode / 2 Fold Back / 3 Restart After Main - Selectable

## ENVIRONMENT

DC OK AKTIV SIGNAL (max.)	20 ~ 30 Vdc
WORKING TEMP.	-25 up to +70 °C (>60°derating 2.5% °C)
HUMIDITY	95 % at 25°C, no condensation
STORAGE TEMP	-40 up to +85 °C
TEMP. COEFFICIENT	± 0.03% / C° (0 – 60 °C)
VIBRATION	In according to IEC60068-2-6

## SAFETY & EMC

SAFETY STANDARDS	UL508 approved, IEC/EN 60950, EN 50178, IEC/EN 60950, EN60950-1, PELV EN 60204-1
WITHSTAND VOLTAGE	I/P-O/P: 3k VAC I/P-FG: 1.6k VAC O/P-FG: 500 VAC
PROTECTION CLASS	IP 20 (EN/IEC 60529)
ISOLATION RESISTANCE	100 MΩ (min) @ 500 Vdc
EMI CONDUCTION & RADIATION	EN61000-6-4
HARMONIC CURRENT	EN61000-3-2
EMS IMMUNITY	EN 61000-4-2, EN 61000-4-3, EN 61000-4-4, EN 61000-4-5, EN 61000-4-6, EN61000-6-2,
NOTE	The power supply is considered a component which will be installed into a final equipment. The final equipment must be re-confirmed that it still meets EMC directives.

## OTHERS

MTBF IEC 61709	> 500.000 h
POLLUTION DEGREE	2
CONNECTION TERMINAL BLOCK	2.5 mm Screw (24 ~ 14 AWG)
DIMENSION	55x110x105 mm ( 2.16x4.33x4.13 in )
PACKING	0.50 kg ( 1.1 lbs) each
NOTE	All parameters NOT specially mentioned are measured at 230V AC input, rated load and 25°C of ambient temperature.

## Mechanical Specification

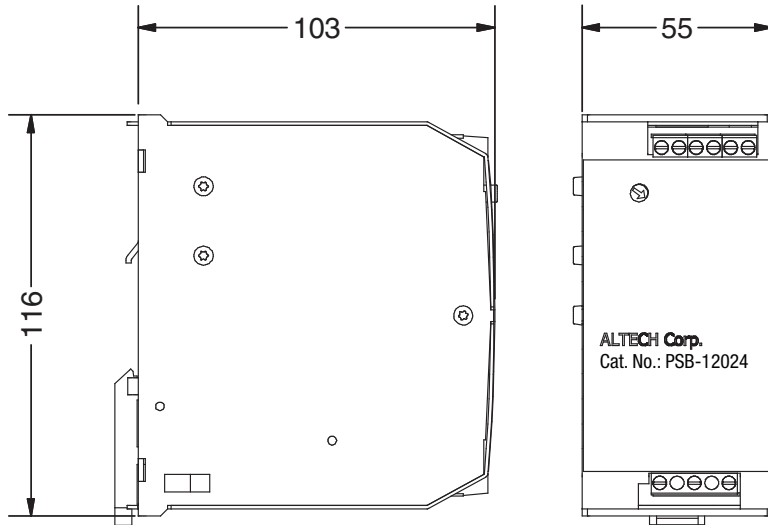

TB1 Terminal Pin. No Assignment

Pin No.	Assignment (2 phase)
1	N / L
2	L / L
3	FG ⊕

TB2 Terminal Pin. No Assignment

Pin No.	Assignment
1,2	DC output -V
3,4	DC output +V
5,6	DC OK relay contacts

## DC OK Relay Contact

Outputs are used for preventive function monitoring of the power supply. An electrically isolated signal contact is available. The signal contact closes when the output power is OK and opens when the output voltage falls below 20Vdc  $\pm$ 5%.

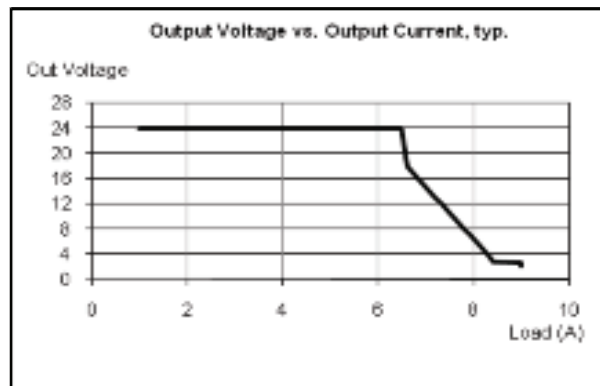

## Output Derating Curve

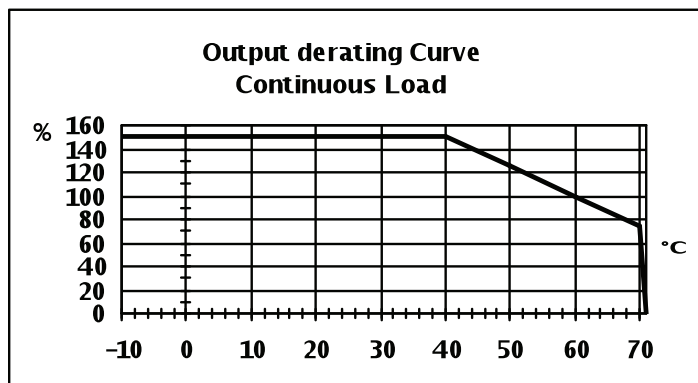

Note: All dimensions are in millimeters, to convert to inches multiply by 0.03937.



# PSB-180 Series (2 Phase) Specifications



## Features:

- Multiple overload/ short circuit protection modes
- Efficiency above 91%
- Small size
- DIN rail mountable
- Cooling by free air convection
- UL508 (industrial control equipment) approved
- EN60950-1
- Built-in DC OK relay contact
- 3 year warranty

## OUTPUT

Cat. No.	PSB-18024
DC VOLTAGE	24 V
RATED CURRENT	7.5 A
CURRENT RANGE	0 - 7.5 A
RATED POWER	180 W
RIPPLE & NOISE (max)	100 mVp-p
VOLTAGE ADJ. RANGE	22 V ~ 27 V
VOLTAGE TOLERANCE	-0.03
START UP WITH STRONG LOAD	≤ 50,000 μF
CURRENT SHORT CIRCUIT I <sub>cc</sub>	16 A
DISSIPATION POWER LOAD P <sub>max</sub>	17 W
LINE REGULATION	± 0.5%
LOAD REGULATION	± 1%
SETUP, RISE TIME	1 sec. (max)
HOLD UP TIME (Typ.)	Typ. 20 msec

Ripple & noise are measured at 20MHz of bandwidth by using a 12" twisted pair-wire terminated with a 0.1μF & 47μF parallel capacitor.

Tolerance: includes set up tolerance, line regulation and load regulation.

Length of set up time is measured at cold first start. Turning ON/OFF the power supply may lead to increase of the set up time.

## INPUT

VOLTAGE RANGE	187 ~ 264 V AC / 330 ~ 550V AC by switch
FREQUENCY RANGE	47 ~ 63 Hz +-6%
EFFICIENCY (Typ.)	>91 %
AC CURRENT (230 – 400 – 500 Vac.)	1.5 ~ 0.8 ~ 0.7 A
INRUSH CURRENT (Typ.)	< 17 A < 5 msec
INTERNAL FUSE	T 4 A
EXTERNAL FUSE (recommended)	10 A (MCB curve B)
LEAKAGE CURRENT	< 1.5 mA @ 500 Vac

## PROTECTION

OVERLOAD	In (60°C) x 1.5 <sup>3</sup> 3 min.; Current max. Overload @ 4Vdc (permanent) I <sub>max</sub> =In (60°C) x (1.8 ~ 2.2)
OVER VOLTAGE	30 ~ 35 Vdc
OVER TEMPERATURE	Yes. Shuts down output and automatically restarts when the temperature inside goes down
SHORT CIRCUIT PROTECTION	1 Hiccup Mode / 2 Fold Back / 3 Restart After Main - Selectable

## ENVIRONMENT

DC OK AKTIV SIGNAL (max.)	20 ~ 30 Vdc
WORKING TEMP.	-25 up to +70 °C (>60°derating 2.5% °C)
HUMIDITY	95 % at 25°C, no condensation
STORAGE TEMP	-40 up to +85 °C
TEMP. COEFFICIENT	± 0.03% / C° (0 ~ 60 °C)
VIBRATION	In according to IEC60068-2-6

## SAFETY & EMC

SAFETY STANDARDS	UL508 approved, IEC/EN 60950, EN 50178, IEC/EN 60950, EN60950-1, PELV EN 60204-1
WITHSTAND VOLTAGE	I/P-O/P: 3k VAC I/P-FG: 1.6k VAC O/P-FG: 500 VAC
PROTECTION CLASS	IP 20 (EN/IEC 60529)
ISOLATION RESISTANCE	100 MΩ (min) @ 500 Vdc
EMI CONDUCTION & RADIATION	EN61000-6-4
HARMONIC CURRENT	EN61000-3-2
EMS IMMUNITY	EN 61000-4-2, EN 61000-4-3, EN 61000-4-4, EN 61000-4-5, EN 61000-4-6, EN61000-6-2, EN61000-6-4,

The power supply is considered a component which will be installed into a final equipment. The final equipment must be re-confirmed that it still meets EMC directives.

## OTHERS

MTBF IEC 61709	> 500.000 h
POLLUTION DEGREE	2
CONNECTION TERMINAL BLOCK	2.5 mm Screw (24 ~ 14 AWG)
DIMENSION	55x110x105 mm ( 2.16x4.33x4.13 in )
PACKING	0.60 kg (1.3 lbs) each
NOTE	All parameters NOT specially mentioned are measured at 230V AC input, rated load and 25°C of ambient temperature.



## Mechanical Specification

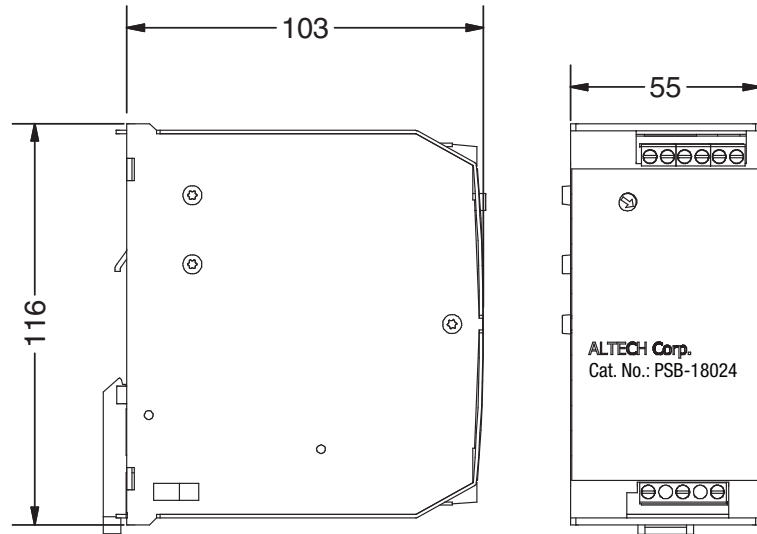

TB1 Terminal Pin. No Assignment

Pin No.	Assignment (2 phase)
1	N / L
2	L / L
3	FG $\oplus$

TB2 Terminal Pin. No Assignment

Pin No.	Assignment
1,2	DC output -V
3,4	DC output +V
5,6	DC OK relay contacts

## DC OK Relay Contact

Outputs are used for preventive function monitoring of the power supply. An electrically isolated signal contact is available. The signal contact closes when the output power is OK and opens when the output voltage falls below 20Vdc  $\pm$ 5%.

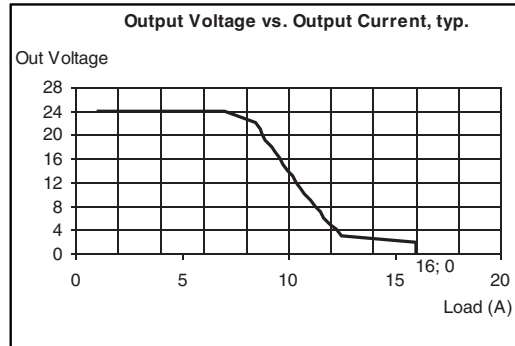

## Output Derating Curve

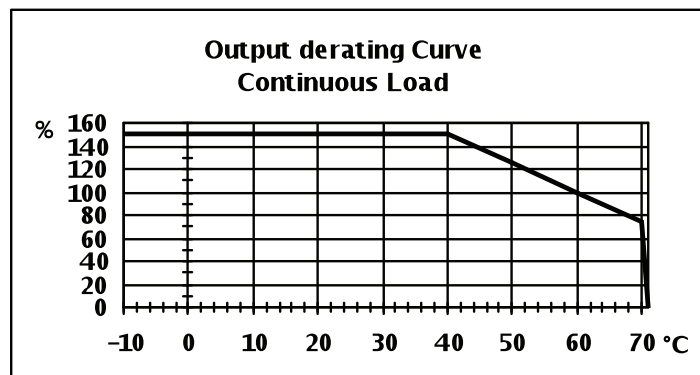

*Note: All dimensions are in millimeters, to convert to inches multiply by 0.03937.*



# PSB-360 Series (2 Phase)

## Specifications



### Features:

- Multiple overload/ short circuit protection modes
- Efficiency above 91%
- Easy parallel connection for more power
- Small size
- DIN rail mountable
- Cooling by free air convection
- UL508 (industrial control equipment) approved
- EN60950-1
- Built-in DC OK relay contact
- 3 year warranty

### OUTPUT

Cat. No.	PSB-36024
DC VOLTAGE	24 V
RATED CURRENT	14 A
CURRENT RANGE	Refer to Output derating curve
RATED POWER	336 W
RIPPLE & NOISE (max)	100 mVp-p
Ripple & noise are measured at 20MHz of bandwidth by using a 12" twisted pair-wire terminated with a 0.1µF & 47µF parallel capacitor.	
VOLTAGE ADJ. RANGE	22 V ~ 27 V
VOLTAGE TOLERANCE	-0.03
Tolerance: includes set up tolerance, line regulation and load regulation.	
START UP WITH STRONG LOAD	≤ 50,000 µF
CURRENT SHORT CIRCUIT I <sub>cc</sub>	30 A
Max 2 sec.: Hiccup mode	
Permanent: Continuous mode	
DISSIPATION POWER LOAD max	28 W
LINE REGULATION	± 0.5%
LOAD REGULATION	± 1%
SETUP, RISE TIME	1 sec. (max)
Length of set up time is measured at cold first start. Turning ON/OFF the power supply may lead to increase of the set up time.	
HOLD UP TIME (Typ.)	Typ. 20 msec

### INPUT

VOLTAGE RANGE	187 ~ 264 V AC / 330 ~ 550V AC by switch
FREQUENCY RANGE	47 ~ 63 Hz +-6%
EFFICIENCY (Typ.)	>91 %
AC CURRENT (230 – 400 – 500 Vac.)	2.2 ~ 1.4 ~ 1.0 A
INRUSH CURRENT (Typ.)	< 17 A < 5 msec
INTERNAL FUSE	T 4 A
EXTERNAL FUSE (recommended)	16 A (MCB curve B)
LEAKAGE CURRENT	< 1.5 mA @ 500 Vac

### PROTECTION

OVERLOAD	In (60°C) x 1.5 <sup>3</sup> 3 min.; Current max. Overload @ 4Vdc (permanent) I <sub>max</sub> =In (60°C) x (1.8 ~ 2.2)
OVER VOLTAGE	30 ~ 35 Vdc
OVER TEMPERATURE	Yes. Shuts down output and automatically restarts when the temperature inside goes down
SHORT CIRCUIT PROTECTION	1 Hiccup Mode / 2 Fold Back / 3 Restart After Main - Selectable

### ENVIRONMENT

DC OK AKTIV SIGNAL (max.)	20 ~ 30 Vdc
WORKING TEMP.	-25 up to +70 °C (>60°derating 2.5% °C)
HUMIDITY	95 % at 25°C, no condensation
STORAGE TEMP	-40 up to +85 °C
TEMP. COEFFICIENT	± 0.03% / C° (0 ~ 60 °C)
VIBRATION	In according to IEC60068-2-6

### SAFETY & EMC

SAFETY STANDARDS	UL508 approved, IEC/EN 60950, EN 50178, IEC/EN 60950, EN60950-1, PELV EN 60204-1
WITHSTAND VOLTAGE	I/P-O/P: 3k VAC I/P-FG: 1.6k VAC O/P-FG: 500 VAC
PROTECTION CLASS	IP 20 (EN/IEC 60529)
ISOLATION RESISTANCE	100 MΩ (min) @ 500 Vdc
EMI CONDUCTION & RADIATION	EN61000-6-4
HARMONIC CURRENT	EN61000-3-2
EMS IMMUNITY	EN 61000-4-2, EN 61000-4-3, EN 61000-4-4, EN 61000-4-5, EN 61000-4-6, EN61000-6-2, EN61000-6-4,
The power supply is considered a component which will be installed into a final equipment. The final equipment must be re-confirmed that it still meets EMC directives.	

### OTHERS

MTBF IEC 61709	> 500.000 h
POLLUTION DEGREE	2
CONNECTION TERMINAL BLOCK	2.5 mm Screw (24 ~ 14 AWG)
DIMENSION	72x115x135 mm ( 2.8x4.5x5.3 in )
PACKING	0.65 kg (1.3 lbs) each
NOTE	All parameters NOT specially mentioned are measured at 230V AC input, rated load and 25°C of ambient temperature.

**Mechanical Specification**

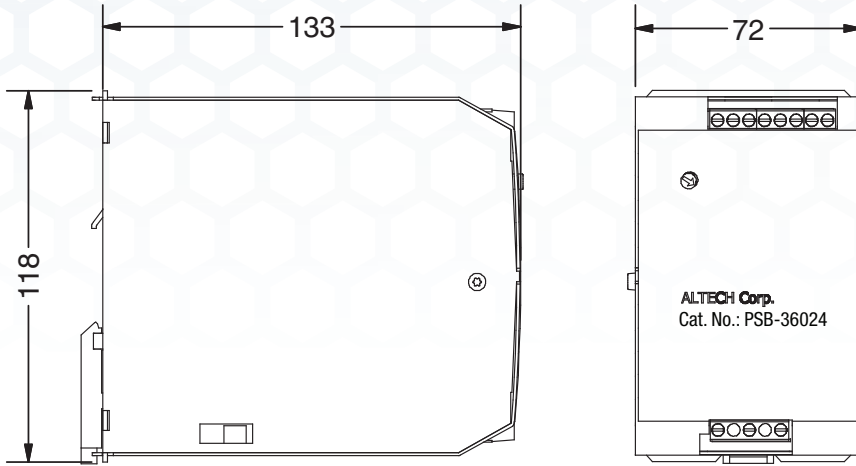

TB1 Terminal Pin. No Assignment

Pin No.	Assignment (2 phase)
1	N/L
2	L/L
3	FG⊕

TB1 Terminal Pin. No Assignment

Pin No.	Assignment
1,2,3	DC output -V
4,5,6	DC output +V
7,8	DC OK relay contacts

**DC OK Relay Contact**

Outputs are used for preventive function monitoring of the power supply. An electrically isolated signal contact is available. The signal contact closes when the output power is OK and opens when the output voltage falls below 20Vdc ±5%.

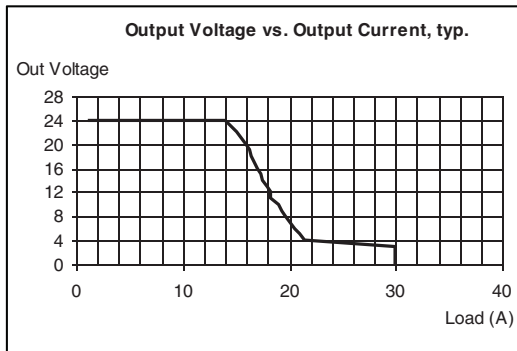

**Output Derating Curve**

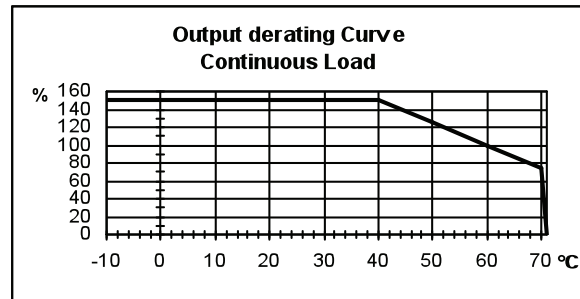

**Parallel Connection**

A parallel connection with the same model power supply can be set up to increase the output power. The output has to be adjusted approximately to the same value (± 20mV) while applying a 1-2 A load to all devices before connecting them in parallel. In PSA-600xx, for more power, the position of the Easy Parallel jumper needs to be changed to enable a parallel connection. In this mode up to 4 power supplies can be put together in parallel.

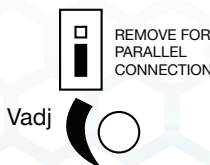
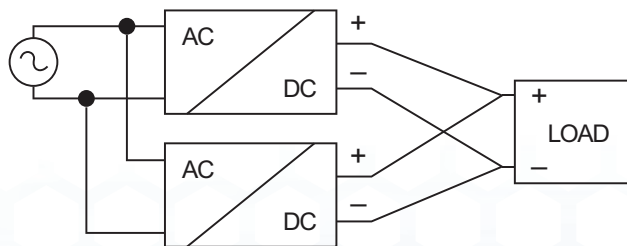

Easy Parallel connection OFF (factory selection)

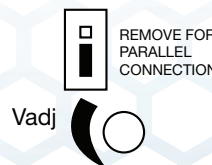

Easy Parallel ON

Note: All dimensions are in millimeters, to convert to inches multiply by 0.03937.

PSC Class 2 Series  
Compact Housing

PSA Flex Series  
1 Phase

PSB Flex Series  
2 & 3 Phase

PS-S Slim Series  
Plastic Housing

PS Low Profile Series  
Plastic Housing

PS Industrial Series  
1, 2 & 3 Phase

PS C & W Series  
1 and 2 Phase

CBI Type  
DC UPS Systems

CB Type  
Battery Chargers

Accessories

Appendix



# PSB-600 Series (3 Phase) Specifications



## Features:

- Multiple overload/ short circuit protection modes
- Efficiency above 92%
- Easy parallel connection for more power
- Small size
- DIN rail mountable
- Cooling by free air convection
- UL508 (industrial control equipment) approved
- EN60950-1
- Built-in DC OK relay contact
- 3 year warranty

## OUTPUT

Cat. No.	PSB-60024
DC VOLTAGE	24 V
RATED CURRENT	25 A
CURRENT RANGE	Refer to Output derating curve
RATED POWER	600 W
RIPPLE & NOISE (max)	100 mVp-p
	Ripple & noise are measured at 20MHz of bandwidth by using a 12" twisted pair-wire terminated with a 0.1µF & 47µF parallel capacitor.
VOLTAGE ADJ. RANGE	22 V ~ 27 V
VOLTAGE TOLERANCE	-0.03
	Tolerance: includes set up tolerance, line regulation and load regulation.
START UP WITH STRONG LOAD	≤ 50,000 µF
CURRENT SHORT CIRCUIT I <sub>cc</sub>	60 A
	Max 2 sec.: Hiccup mode
	Permanent: Continuous mode
DISSIPATION POWER LOAD mas	28 W
LINE REGULATION	± 0.5%
LOAD REGULATION	± 1%
SETUP, RISE TIME	1 sec. (max)
	Length of set up time is measured at cold first start. Turning ON/OFF the power supply may lead to increase of the set up time.
HOLD UP TIME (Typ.)	Typ. 20 msec

## INPUT

VOLTAGE RANGE	330 ~ 550V AC
FREQUENCY RANGE	47 ~ 63 Hz +6%
EFFICIENCY (Typ.)	>92 %
AC CURRENT (330 – 500 Vac.)	0.95 – 0.85 A
INRUSH CURRENT (Typ.)	< 17 A < 5 msec
INTERNAL FUSE	T 6.3 A
EXTERNAL FUZE (recommended)	16 A (MCB curve B)
LEAKAGE CURRENT	< 1.5 mA @ 500 Vac

## PROTECTION

OVERLOAD	In (60°C) x 1.5 <sup>3</sup> 3 min.;
	Current max. Overload @ 4Vdc (permanent) I <sub>max</sub> =In (60°C) x (1.8 ~ 2.2)
OVER VOLTAGE	30 ~ 35 Vdc
OVER TEMPERATURE	Yes. Shuts down output and automatically restarts when the temperature inside goes down
SHORT CIRCUIT PROTECTION	1 Hiccup Mode / 2 Fold Back / 3 Restart After Main

## ENVIRONMENT

DC OK AKTIV SIGNAL (max.)	20 ~ 30 Vdc
WORKING TEMP.	-25 up to +70 °C
	(>60°derating 2.5% °C)
HUMIDITY	95 % at 25°C, no condensation
STORAGE TEMP	-40 up to +85 °C
TEMP. COEFFICIENT	± 0.03% / C° (0 ~ 60 °C)
VIBRATION	In according to IEC60068-2-6

## SAFETY & EMC

SAFETY STANDARDS	UL508 approved, IEC/EN 60950, EN 50178, IEC/EN 60950, EN60950-1, PELV EN 60204-1
WITHSTAND VOLTAGE	I/P-O/P: 3k VAC I/P-FG: 1.6k VAC O/P-FG: 500 VAC
PROTECTION CLASS	IP 20 (EN/IEC 60529)
ISOLATION RESISTANCE	100 MΩ (min) @ 500 Vdc
EMI CONDUCTION & RADIATION	EN61000-6-4
HARMONIC CURRENT	EN61000-3-2
EMS IMMUNITY	EN 61000-4-2, EN 61000-4-3, EN 61000-4-4, EN 61000-4-5, EN 61000-4-6, EN61000-6-2, EN61000-6-4,
	The power supply is considered a component which will be installed into a final equipment. The final equipment must be re-confirmed that it still meets EMC directives.

## OTHERS

MTBF IEC 61709	> 500.000 h
POLLUTION DEGREE	2
CONNECTION TERMINAL BLOCK	2.5 mm Screw (24 ~ 14 AWG)
DIMENSION	85x120x140 mm (3.34x4.72x5.51 in )
PACKING	0.75 kg (1.9 lbs) each
NOTE	All parameters NOT specially mentioned are measured at 230V AC input, rated load and 25°C of ambient temperature.

## Mechanical Specification

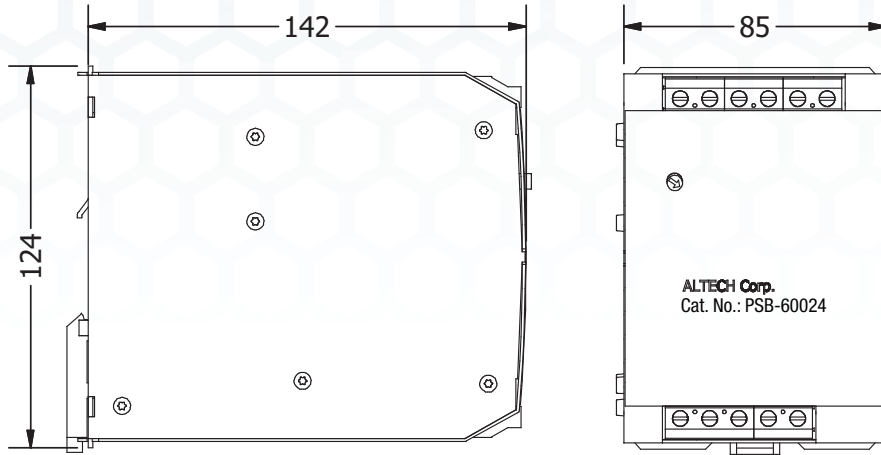

TB1 Terminal Pin. No Assignment

Pin No.	Assignment (3 phase)
1	L1
2	L2
3	L3
4	FG ⊕
5	FG ⊕

TB2 Terminal Pin. No Assignment

Pin No.	Assignment
1,2	DC output -V
3,4	DC output +V
5,6	DC OK relay contacts

### DC OK Relay Contact

Outputs are used for preventive function monitoring of the power supply. An electrically isolated signal contact is available. The signal contact closes when the output power is OK and opens when the output voltage falls below 20Vdc ±5%.

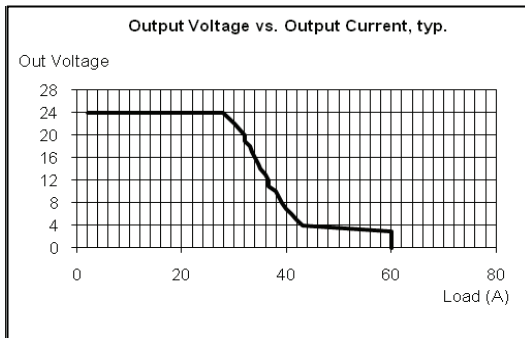

### Output Derating Curve

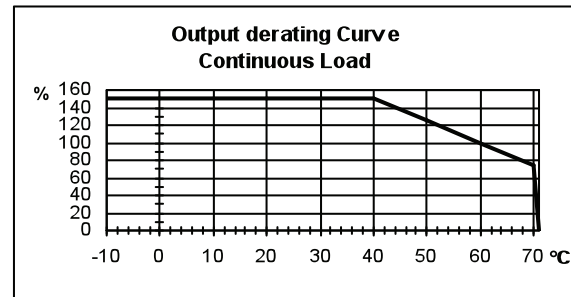

### Parallel Connection

A parallel connection with the same model power supply can be set up to increase the output power. The output has to be adjusted approximately to the same value (± 20mV) while applying a 1-2 A load to all devices before connecting them in parallel. In PSA-600xx, for more power, the position of the Easy Parallel jumper needs to be changed to enable a parallel connection. In this mode up to 4 power supplies can be put together in parallel.

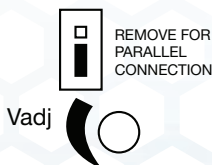
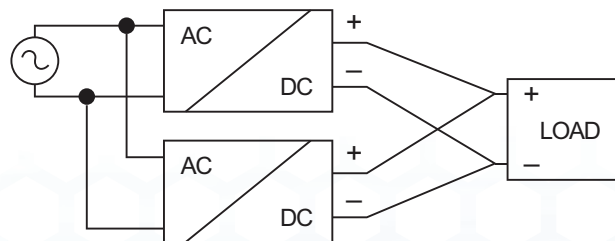

Easy Parallel connection  
OFF (factory selection)

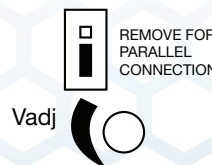

Easy Parallel  
ON

Note: All dimensions are in millimeters, to convert to inches multiply by 0.03937.



## Slimline Single Phase Power Supply

ALTECH's slim type DIN rail switching power supply, PS-S Series designed for the fast growing demand of low wattage DIN rail applications. These 10W to 100W models are enclosed with fully isolated plastic case to prevent users from hazardous shock. The design complies with the slim trend that the precious space on the industrial rail can be saved effectively. Featuring up to 84% of efficiency, this series is cooled by only free air convection up to 70°C that significantly increase the reliability and lifetime of the power supply. Another important feature of PS-S Series is its low power consumption (<0.75W). This unique characteristic can significantly expand the application of PS-S series beyond just heavy industrial field, but can also be implied to datacom or IT applications that require green power to save the energy and to obey the anticipated government laws in the near future!

Short circuit protection, overload protection, over voltage protection, and the DC OK signal for monitoring the status of power supply are standard functions for the PS-S Series. Typical applications includes factory automation, process control, electro-mechanical industry, datacom and IT.

- Input voltage range: 85 - 264V AC; 120-370V DC
- AC inrush current (max): Cold start: 20A at 115V AC,; 40A at 230V DC
- DC adjustment range:  $\pm 10\%$  rated output voltage
- Overload protection: 105% - 160% constant current limiting (auto- recovery)
- Over-voltage protection: 115% - 135% rated output voltage
- Setup, rise, time (max): 500ms, 30ms/230V AC  
1000ms, 30ms/115V AC, at full load
- Withstand voltage: I/P-O/P: 3KV AC, I/P-FG:1.5KV AC, O/P-FG:0.5KV AC
- Working temperature: -20 to +70°C (-4° to +158°F), refer to output derating curve
- Safety standards: UL508, EN60950-1
- EMC standards: EN55022 class B  
EN61000-4-2,3,4,5,6,8,11  
ENV50204; EN55024; EN61000-6-1; EN61204-3;  
Light Industry Level criteria A
- Military Standard MIL-HDBK-217F



# PS-S Series



## Features:

- Universal AC input/Full range
- Protections: Short circuit / Overload / Overvoltage
- Cooling by free air convection
- DIN rail mountable
- NEC class 2 / LPS compliant (12V,24V,48V only)
- LED indicator for power on
- DC OK relay contact
- No load power consumption < 0.75W
- 100% full load burn-in test
- 3 year warranty

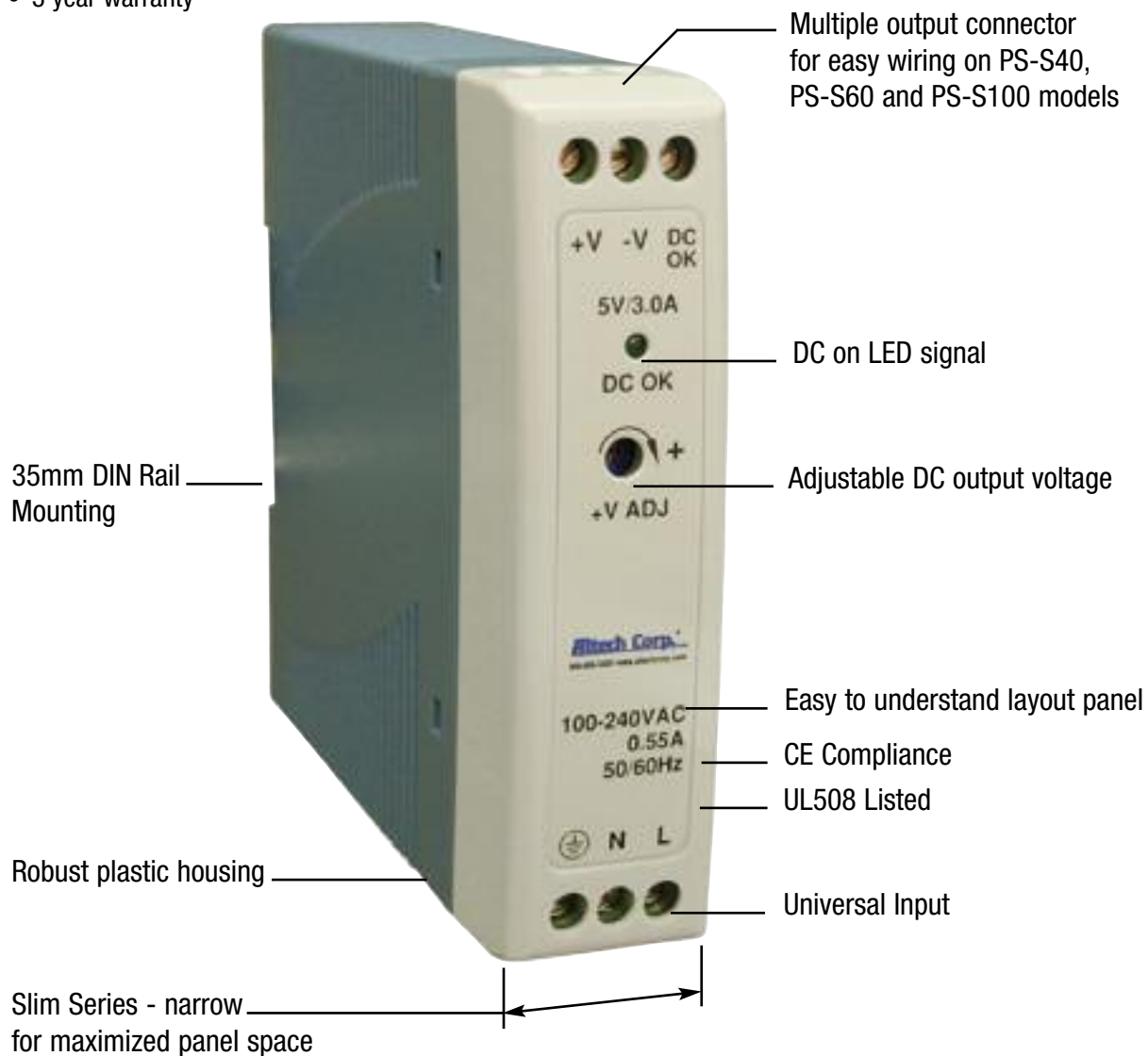

# 10-100W Slimline POWER SUPPLIES



## 10W Single Output Industrial DIN Rail Power Supply

Cat. No.	Output		Tol. %	Ripple & Noise	Efficiency	NOTES
	V DC	A				
PS-S1005	5V DC	2A	±5%	80 mVp-p	77%	
PS-S1012	12V DC	0.84A	±3%	120 mVp-p	81%	
PS-S1015	15V DC	0.67A	±3%	120 mVp-p	81%	
PS-S1024	24V DC	0.42A	±2%	150 mVp-p	84%	



## 20W Single Output Industrial DIN Rail Power Supply

Cat. No.	Output		Tol. %	Ripple & Noise	Efficiency	NOTES
	V DC	A				
PS-S2005	5V DC	3A	±2%	80 mVp-p	76%	
PS-S2012	12V DC	1.67A	±1%	120 mVp-p	80%	
PS-S2015	15V DC	1.34A	±1%	120 mVp-p	81%	
PS-S2024	24V DC	1A	±1%	150 mVp-p	84%	



## 40W Single Output Industrial DIN Rail Power Supply

Cat. No.	Output		Tol. %	Ripple & Noise	Efficiency	NOTES
	V DC	A				
PS-S4005	5V DC	6A	±2%	80 mVp-p	78%	
PS-S4012	12V DC	3.33A	±1%	120 mVp-p	86%	
PS-S4024	24V DC	1.7A	±1%	150 mVp-p	88%	
PS-S4048	48V DC	0.83A	±1%	200 mVp-p	88%	



## 60W Single Output Industrial DIN Rail Power Supply

Cat. No.	Output		Tol. %	Ripple & Noise	Efficiency	NOTES
	V DC	A				
PS-S6005	5V DC	10A	±2%	80 mVp-p	78%	
PS-S6012	12V DC	5A	±1%	120 mVp-p	86%	
PS-S6024	24V DC	2.5A	±1%	150 mVp-p	88%	
PS-S6048	48V DC	1.25A	±1%	200 mVp-p	87%	



## 100W Single Output Industrial DIN Rail Power Supply

Cat. No.	Output		Tol. %	Ripple & Noise	Efficiency	NOTES
	V DC	A				
PS-S10012	12V DC	7.5A	±1%	120 mVp-p	85%	
PS-S10024	24V DC	4A	±1%	150 mVp-p	86%	
PS-S10048	48V DC	2A	±1%	200 mVp-p	88%	

# SPECIFICATIONS

## PS-S10 Series

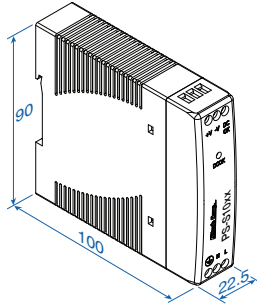

### Terminal Pin. No Assign. (TB1)

Pin No.	Assignment
1	FG ⊕
2	AC/N
3	AC/L

### Terminal Pin. No Assign. (TB2)

Pin No.	Assignment
4	DC OUTPUT +V
5	DC OUTPUT -V
6	DC OK SIGNAL

Universal Input: 85-264V AC, 120-370V DC full range;  
0.33A @ 110V AC; 0.21A @ 230V AC

Connection: Input - 2 poles, Output - 2 poles, single screw terminal  
Size (WxHxD): 22.5x90x100mm (0.89x3.54x3.94 inches)

Packaging: 1/box; 0.37lbs / 0.17Kg

## PS-S20 Series

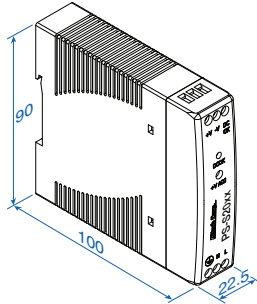

### Terminal Pin. No Assign. (TB1)

Pin No.	Assignment
1	FG ⊕
2	AC/N
3	AC/L

### Terminal Pin. No Assign. (TB2)

Pin No.	Assignment
4	DC OUTPUT +V
5	DC OUTPUT -V
6	DC OK SIGNAL

Universal Input: 85-264V AC, 120-370V DC full range;  
0.55A @ 110V AC; 0.35A @ 230V AC

Connection: Input - 2 poles, Output - 2 poles, single screw terminal  
Size (WxHxD): 22.5x90x100mm (0.89x3.54x3.94 inches)

Packaging: 1/box; 0.42lbs / 0.19Kg

## PS-S40 Series

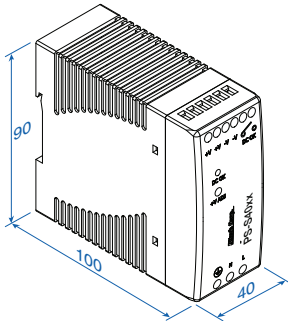

### Terminal Pin. No Assign. (TB1)

Pin No.	Assignment
1	FG ⊕
2	AC/N
3	AC/L

### Terminal Pin. No Assign. (TB2)

Pin No.	Assignment
1/2	DC OUTPUT +V
3/4	DC OUTPUT -V
5/6	DC OK Relay Contact

Universal Input: 85-264V AC, 120-370V DC full range;  
1.1A @ 115V AC, 0.7A @ 370V AC

Connection: Input - 2 poles, Output - 2 poles, double screw terminal  
Size (WxHxD): 40x90x100mm (1.57x3.54x3.94 inches)

Packaging: 1/box; 0.66lbs / 0.3Kg

## PS-S60 Series

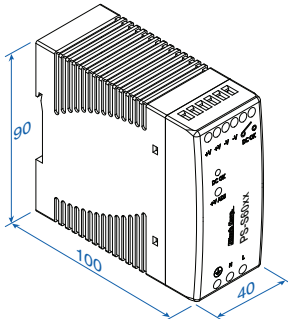

### Terminal Pin. No Assign. (TB1)

Pin No.	Assignment
1	FG ⊕
2	AC/N
3	AC/L

### Terminal Pin. No Assign. (TB2)

Pin No.	Assignment
1/2	DC OUTPUT +V
3/4	DC OUTPUT -V
5/6	DC OK Relay Contact

Universal Input: 85-264V AC, 120-370V DC full range;  
1.8A @ 115V AC, 1A @ 370V AC

Connection: Input - 2 poles, Output - 2 poles, double screw terminal  
Size (WxHxD): 40x90x100mm (1.57x3.54x3.94 inches)

Packaging: 1/box; 0.73lbs / 0.33Kg

## PS-S100 Series

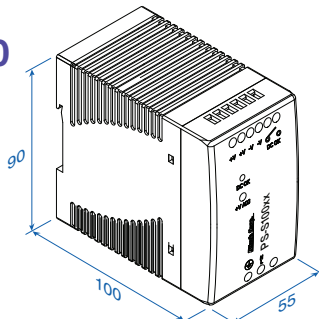

### Terminal Pin. No Assign. (TB1)

Pin No.	Assignment
1	FG ⊕
2	AC/N
3	AC/L

### Terminal Pin. No Assign. (TB2)

Pin No.	Assignment
1/2	DC OUTPUT +V
3/4	DC OUTPUT -V
5/6	DC OK Relay Contact

Universal Input: 85-264V AC, 120-370V DC full range;  
1.3A @ 115V AC, 0.8A @ 230V AC

Connection: Input - 2 poles, Output - 2 poles, double screw terminal  
Size (WxHxD): 55x90x100mm (2.17x3.54x3.94 inches)

Packaging: 1/box; 0.93lbs / 0.42Kg



# PS-S10 Series Specifications



## Features:

- Universal AC input / full range
- Protections: Short Circuit / Overload / Overvoltage
- Cooling by free air convection
- DIN rail mountable
- Built in DC OK active signal
- LED indicator for power on
- No load power consumption < 0.75W
- 100% full load burn-in test
- 3 year warranty

## OUTPUT

Cat. No.	PS-S1005	PS-S1012	PS-S1015	PS-S1024
----------	----------	----------	----------	----------

DC VOLTAGE	5V	12V	15V	24V
RATED CURRENT	2A	0.84A	0.67A	0.42A
CURRENT RANGE	0~2A	0~0.84A	0~0.67A	0~0.42A
RATED POWER	10W	10W	10W	10W
RIPPLE & NOISE (max)	80mVp-p	120mVp-p	120mVp-p	150mVp-p
VOLTAGE TOLERANCE	±5.0%	±3.0%	±3.0%	±2.0%
LINE REGULATION	±1.0%	±1.0%	±1.0%	±1.0%
LOAD REGULATION	±5.0%	±3.0%	±3.0%	±2.0%
SETUP, RISE TIME	500ms, 30ms/230VAC; 1000ms, 30ms/115VAC at full load			
HOLD UP TIME (Typ.)	120ms/230VAC; 25ms/115VAC at full load			

Ripple & noise are measured at 20MHz of bandwidth by using a 12 twisted pair-wire terminated with a 0.1µF & 47µF parallel capacitor  
Tolerance: includes set up tolerance, line regulation and load regulation.  
Length of set up time is measured at cold first start. Turning ON/OFF the power supply may lead to increase of the set up time.

## INPUT

VOLTAGE RANGE	85~264VAC; 120~370VDC			
FREQUENCY RANGE	47~63Hz			
EFFICIENCY (Typ.)	77%	81%	81%	84%
AC CURRENT (max.)	0.33A/115VAC; 0.21A/230VAC			
INRUSH CURRENT (Typ.)	COLD START: 35A/115VAC; 70A/230VAC			
LEAKAGE CURRENT	<1mA/ 240VAC			

## PROTECTION

OVERLOAD PROTECTION	Above 105% rated output power Protection type: Hiccup mode, recovers automatically after fault condition is removed			
OVERVOLTAGE PROTECTION	5.75~6.75V	13.8~16.2V	17.25~20.25V	27.6~32.4V
OVER TEMPERATURE PROTECTION	Protection type: Shut down overvoltage, re-power on to recover Power supply shut down at 70°C constant current limiting / output voltage goes to 0; re-power on to recover			
DC OK AKTIV SIGNAL (max.)	3.75~6V (50mA)	9~13.5V (40mA)	11.5~16.5V (40mA)	18~27V (20mA)

## ENVIRONMENT

WORKING TEMP.	-20 ~ +70°C (Refer to output load derating curve)			
WORKING HUMIDITY	20 ~ 90% RH non-condensing			
STORAGE TEMP. / HUMIDITY	-40 ~ +85°C; 10 ~ 95% RH			
TEMP. COEFFICIENT	±0.03% °C (0 ~ 50°C)			
VIBRATION	Component: 10 ~ 500Hz, 2G 10min. / 1cycle, 60 min. each long X,Y, Z axes			
MOUNTING	Compliance to IEC60068-2-6			

## SAFETY & EMC

SAFETY STANDARDS	UL508 EN60950-1 compliant			
WITHSTAND VOLTAGE	I/P-O/P: 3KVAC I/P-FG: 1.5KVAC O/P-FG: 0.5KVAC			
ISOLATION RESISTANCE	I/P-O/P, I/P-FG, O/P-FG: 100M Ohms/500VDC			
EMI CONDUCTION & RADIATION	Compliance to EN55011 EN55022 (CISPR22) EN61204-3 Class B			
HARMONIC CURRENT	Compliance to EN61000-3-2,-3			
EMS IMMUNITY	Compliance to EN61000-4-2,3,4,5,6,8,11; EN55024; EN61000-6-1;EN61204-3; light industry level; criteria A			
	The power supply is considered a component which will be installed into a final equipment. The final equipment must be re-confirmed that it still meets EMC directives.			

## OTHERS

MTBF	584K hrs min. MIL-HDBK-217K (25°C)			
DIMENSION	22.5x90x100mm (WxHxD)			
PACKING	0.17Kg; 72pcs / 13.2Kg / 0.91CUFT			
	All parameters NOT specially mentioned are measured at 230V AC input, rated load and 25°C of ambient temperature			

## Mechanical Specification

Terminal Pin. No Assign. (TB1)

Pin No.	Assignment
1	FG ⊕
2	AC/N
3	AC/L

Terminal Pin. No Assign. (TB2)

Pin No.	Assignment
4	DC OUTPUT +V
5	DC OUTPUT -V
6	DC OK SIGNAL

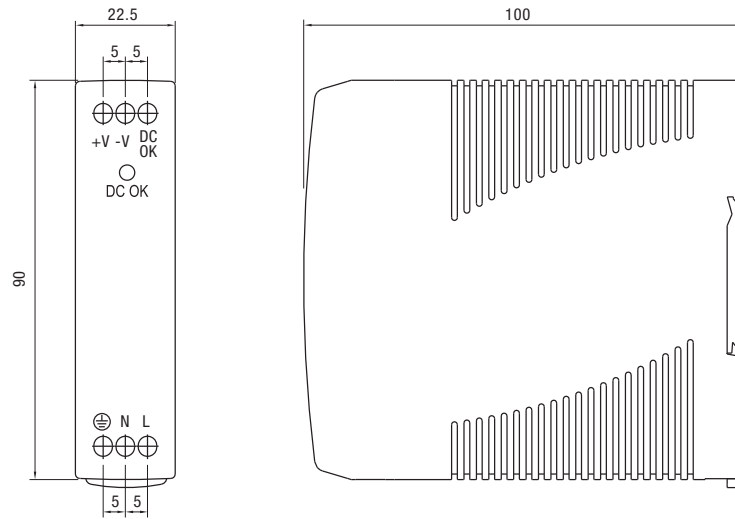

## Block Diagram

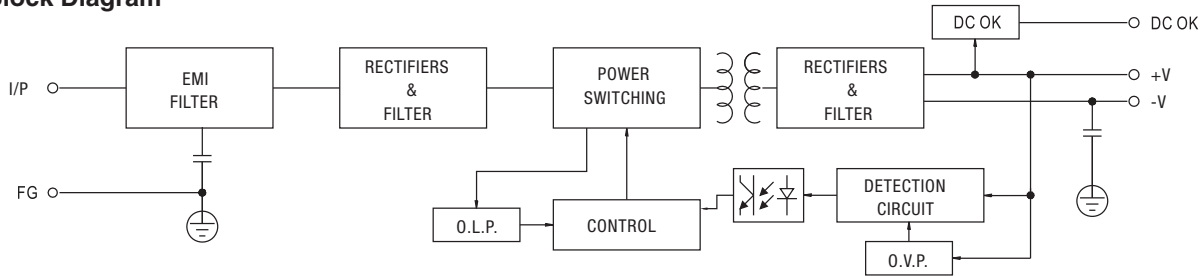

## Application of DC OK Signal

(a) 5V signal

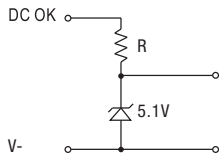

Model	R
5V	≥ 200Ω
12V	≥ 1.5KΩ
15V	≥ 2KΩ
24V	≥ 3.9KΩ

(b) LED

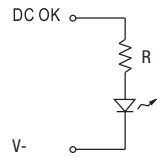

Model	R
5V	≥ 1KΩ
12V	≥ 2.4KΩ
15V	≥ 3KΩ
24V	≥ 4.7KΩ

(c) Relay

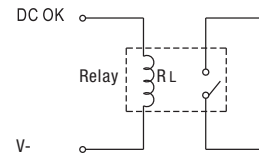

Model	RL
5V	≥ 120Ω
12V	≥ 700Ω
15V	≥ 700Ω
24V	≥ 1.2KΩ

## Derating Curve

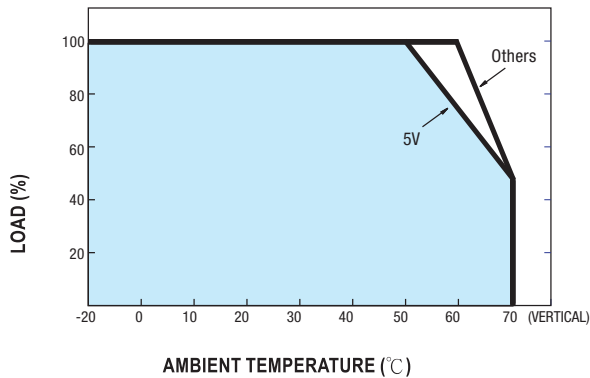

## Output Derating VS Input Voltage

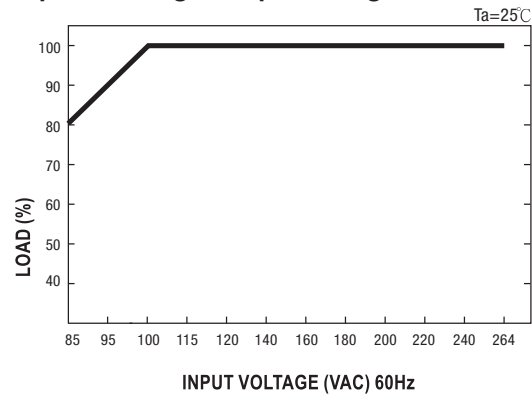

Note: All dimensions are in millimeters, to convert to inches multiply by 0.03937.



# PS-S20 Series Specifications



## Features:

- Universal AC input / full range
- Protections: Short Circuit / Overload / Overvoltage
- Cooling by free air convection
- DIN rail mountable
- Built in DC OK active signal
- LED indicator for power on
- No load power consumption < 0.75W
- 100% full load burn-in test
- 3 year warranty

## OUTPUT

Cat. No.	PS-S2005	PS-S2012	PS-S2015	PS-S2024
----------	----------	----------	----------	----------

DC VOLTAGE	5V	12V	15V	24V
RATED CURRENT	3A	1.67A	1.34A	1A
CURRENT RANGE	0~3A	0~1.67A	0~1.34A	0~1A
RATED POWER	15W	20W	20W	24W
RIPPLE & NOISE (max)	80mVp-p	120mVp-p	120mVp-p	150mVp-p
Ripple & noise are measured at 20MHz of bandwidth by using a 12" twisted pair-wire terminated with a 0.1µF & 47µF parallel capacitor				
VOLTAGE ADJ. RANGE	4.75 ~ 5.5V	10.8 ~ 13.2V	13.5 ~ 16.5V	21.6 ~ 26.4V
VOLTAGE TOLERANCE	±2.0%	±1.0%	±1.0%	±1.0%
Tolerance: includes set up tolerance, line regulation and load regulation.				
LINE REGULATION	±1.0%	±1.0%	±1.0%	±1.0%
LOAD REGULATION	±1.0%	±1.0%	±1.0%	±1.0%
SETUP, RISE TIME	500ms, 30ms/230VAC; 1000ms, 30ms/115VAC at full load			
Length of set up time is measured at cold first start. Turning ON/OFF the power supply may lead to increase of the set up time.				
HOLD UP TIME (Typ.)	50ms/230VAC; 20ms/115VAC at full load			

## INPUT

VOLTAGE RANGE	85~264VAC	120~370VDC		
FREQUENCY RANGE	47~63Hz			
EFFICIENCY (Typ.)	76%	80%	81%	84%
AC CURRENT (max.)	0.55A/115VAC; 0.35A/230VAC			
INRUSH CURRENT (Typ.)	COLD START: 20A/115VAC; 40A/230VAC			
LEAKAGE CURRENT	≤1mA/ 240VAC			

## PROTECTION

OVERLOAD PROTECTION	105% ~ 160% rated output power Protection type: Constant current limiting, recovers automatically after fault condition is removed			
OVERVOLTAGE PROTECTION	5.75~6.75V	13.8~16.2V	17.25~20.25V	27.6~32.4V
Protection type: Shut down overvoltage, re-power on to recover				
OVER TEMPERATURE PROTECTION	Power supply shut down at 70°C constant current limiting / output voltage goes to 0; re-power on to recover			
DC OK AKTIV SIGNAL (max.)	3.75~6V (50mA)	9~13.5V (40mA)	11.5~16.5V (40mA)	18~27V (20mA)

## ENVIRONMENT

WORKING TEMP.	-20 ~ +70°C (Refer to output load derating curve)
WORKING HUMIDITY	20 ~ 90% RH non-condensing
STORAGE TEMP., HUMIDITY	-40 ~ +85°C, 10 ~ 95% RH
TEMP. COEFFICIENT	±0.03% °C (0 ~ 50°C)
VIBRATION	Component: 10 ~ 500Hz, 2G 10min. / 1cycle, 60 min. each long X,Y, Z axes
MOUNTING	Compliance to IEC60068-2-6

## SAFETY & EMC

SAFETY STANDARDS	UL508 EN60950-1 compliant
WITHSTAND VOLTAGE	I/P-O/P: 3KVAC I/P-FG: 1.5KVAC O/P-FG: 0.5KVAC
ISOLATION RESISTANCE	I/P-O/P, I/P-FG, O/P-FG: 100M Ohms/500VDC
EMI CONDUCTION & RADIATION	Compliance to EN55011 EN55022 (CISPR22) EN61204-3 Class B
HARMONIC CURRENT	Compliance to EN61000-3-2,-3
EMS IMMUNITY	Compliance to EN61000-4-2,3,4,5,6,8,11; EN55024; ENV50204; EN61000-6-1;EN61204-3; light industry level; criteria A
The power supply is considered a component which will installed into a final equipment. The final equipment must be re-confirmed that it still meets EMC directives.	

## OTHERS

MTBF	236.9K hrs min. MIL-HDBK-217K (25°C)
DIMENSION	22.5x90x100mm (WxHxD)
PACKING	0.19Kg; 72pcs / 14.7Kg / 0.91CUFT
All parameters NOT specially mentioned are measured at 230V AC input, rated load and 25°C of ambient temperature	



## Mechanical Specification

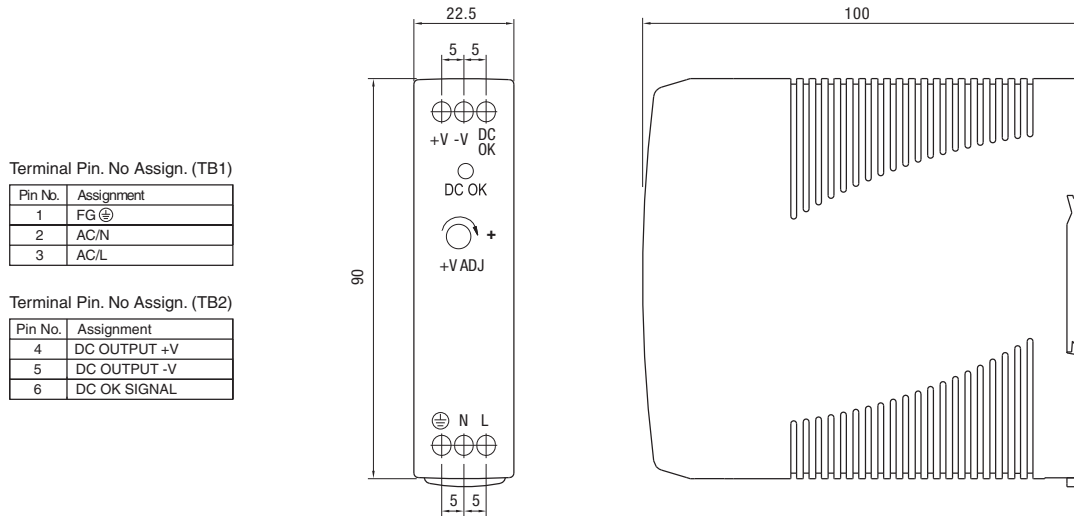

## Block Diagram

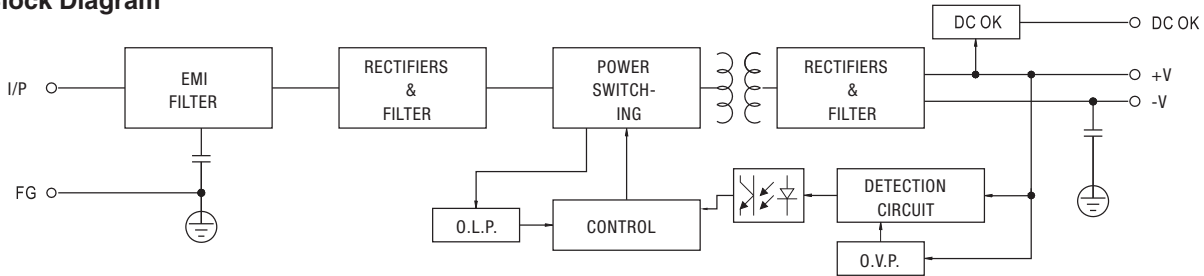

## Application of DC OK Signal

### (a) 5V signal

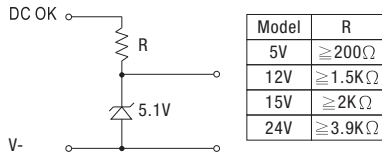

### (b) LED

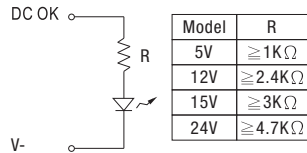

### (c) Relay

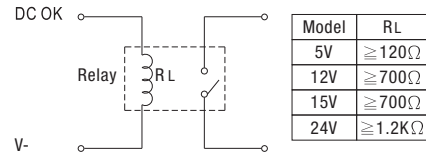

## Derating Curve

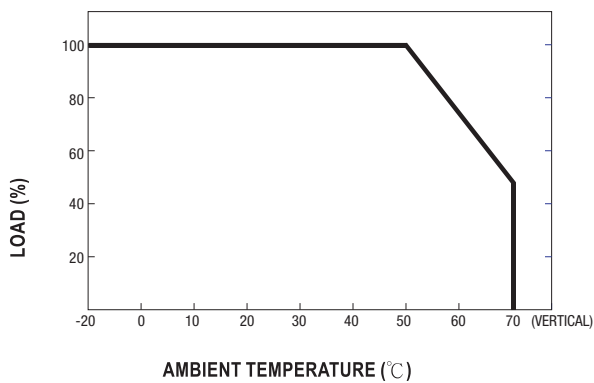

## Output Derating VS Input Voltage

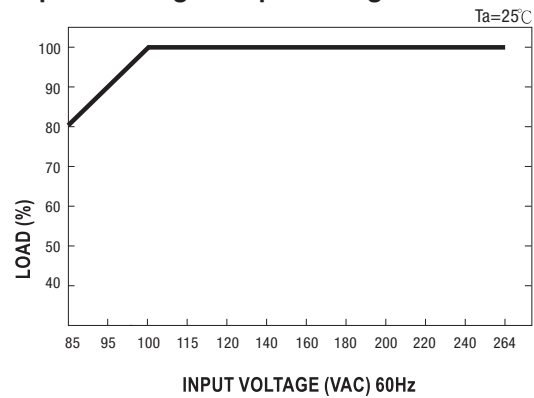

Note: All dimensions are in millimeters, to convert to inches multiply by 0.03937.



# PS-S40 Series Specifications



## Features:

- Universal AC input/full range
- Protections: Short Circuit / Overload / Overvoltage
- Cooling by free air convection
- DIN rail mountable
- LED indicator for power on DC OK relay contact
- No load power consumption < 0.75W
- 100% full load burn-in test
- 3 year warranty

## OUTPUT

Cat. No.	PS-S4005	PS-S4012	PS-S4024	PS-S4048
----------	----------	----------	----------	----------

DC VOLTAGE	5V	12V	24V	48V
RATED CURRENT	6A	3.33A	1.7A	0.83A
CURRENT RANGE	0~6A	0~3.33A	0~1.7A	0~0.83A
RATED POWER	30W	40W	40.8W	39.8W
RIPPLE & NOISE (max)	80mVp-p	120mVp-p	150mVp-p	200mVp-p
Ripple & noise are measured at 20MHz of bandwidth by using a 12 twisted pair-wire terminated with a 0.1µF & 47µF parallel capacitor				
VOLTAGE ADJ. RANGE	5 ~ 6V	12 ~ 15V	24 ~ 30V	48 ~ 56V
VOLTAGE TOLERANCE	±2.0%	±1.0%	±1.0%	±1.0%
Tolerance: includes set up tolerance, line regulation and load regulation.				
LINE REGULATION	±1.0%	±1.0%	±1.0%	±1.0%
LOAD REGULATION	±1.0%	±1.0%	±1.0%	±1.0%
SETUP, RISE TIME	500ms, 30ms/230VAC; 500ms, 30ms/115VAC at full load			
Length of set up time is measured at cold first start. Turning ON/OFF the power supply may lead to increase of the set up time.				
HOLD UP TIME (Typ.)	50ms/230VAC; 20ms/115VAC at full load			

## INPUT

VOLTAGE RANGE	85~264VAC	120~370VDC		
FREQUENCY RANGE	47~63Hz			
EFFICIENCY (Typ.)	78%	86%	88%	88%
AC CURRENT (max)	1.1A/115VAC; 0.7A/230VAC			
INRUSH CURRENT (Typ.)	COLD START: 30A/115VAC; 60A/230VAC			
LEAKAGE CURRENT	≤1mA/ 240VAC			

## PROTECTION

OVERLOAD PROTECTION	105% ~ 150% rated output power Protection type: Constant current limiting, recovers automatically after fault condition is removed			
OVERVOLTAGE PROTECTION	6.25~7.25V	15.6~18V	31.2~36V	57.6~64.8V
Protection type: Shut down overvoltage, re-power on to recover				
OVER TEMPERATURE PROTECTION	Power supply shut down at 70°C constant current limiting / output voltage goes to 0; re-power on to recover			
DC OK AKTIV SIGNAL (max.)	Relay contact rating (max.): 30V/ 1A resistive			

## ENVIRONMENT

WORKING TEMP.	-20 ~ +70°C (Refer to output load derating curve)			
WORKING HUMIDITY	20 ~ 90% RH non-condensing			
STORAGE TEMP., HUMIDITY	-40 ~ +85°C, 10 ~ 95% RH			
TEMP. COEFFICIENT	±0.03% °C (0 ~ 50°C)			
VIBRATION	Component: 10 ~ 500Hz, 2G 10min. / 1 cycle, 60 min. each long X,Y, Z axes			
MOUNTING	Compliance to IEC60068-2-6			

## SAFETY & EMC

SAFETY STANDARDS	UL508 EN60950-1 compliant			
WITHSTAND VOLTAGE	I/P-O/P: 3KVAC I/P-FG: 1.5KVAC O/P-FG: 0.5KVAC			
ISOLATION RESISTANCE	I/P-O/P, I/P-FG, O/P-FG: ≥100M Ohms/500VDC (25°C; 70% RH)			
EMI CONDUCTION & RADIATION	Compliance to EN55011 EN55022 (CISPR22) EN61204-3 Class B			
HARMONIC CURRENT	Compliance to EN61000-3-2,-3			
EMS IMMUNITY	Compliance to EN61000-4-2,3,4,5,6,8,11; EN55024; ENV50204 ; EN61000-6-2; EN61204-3; light industry level; criteria A			
The power supply is considered a component which will be installed into a final equipment. The final equipment must be re-confirmed that it still meets EMC directives.				

## OTHERS

MTBF	301.7K hrs min. MIL-HDBK-217K (25°C)			
DIMENSION	40x90x100mm (WxHxD)			
PACKING	0.3Kg; 42pcs / 13.6 Kg / 0.82CUFT			
All parameters NOT specially mentioned are measured at 230V AC input, rated load and 25°C of ambient temperature.				

## Mechanical Specification

Terminal Pin. No Assign. (TB1)

Pin No.	Assignment
1	FG ⊕
2	AC/N
3	AC/L

Terminal Pin. No Assign. (TB2)

Pin No.	Assignment
1,2	DC OUTPUT +V
3,4	DC OUTPUT -V
5,6	DC OK RELAY CONTACT

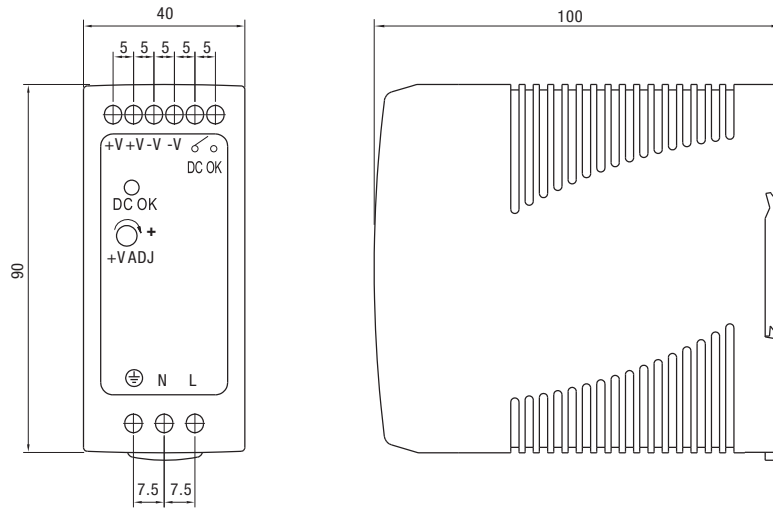

## Block Diagram

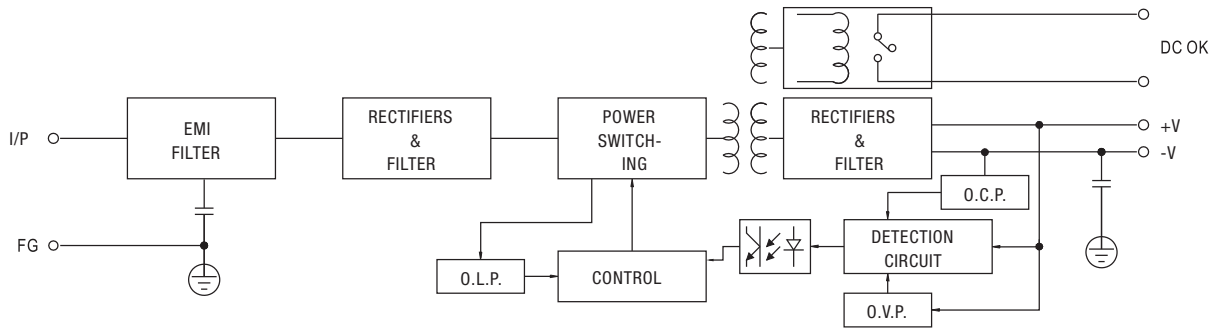

## DC OK Relay Contact

Contact Close	When the output voltage reaches the adjusted output voltage.
Contact Open	When the output voltage drop more than 90% output voltage.
Contact Ratings (max.)	30V/1A resistive load

## Derating Curve

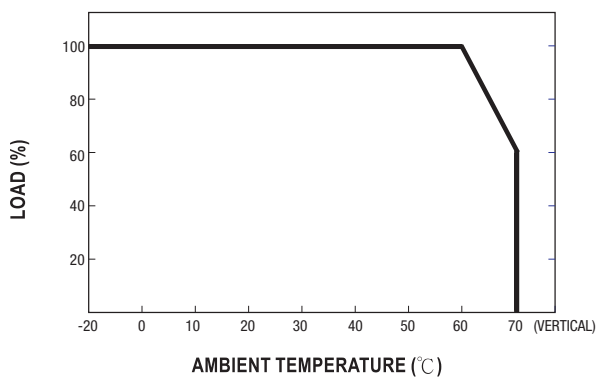

## Output Derating VS Input Voltage

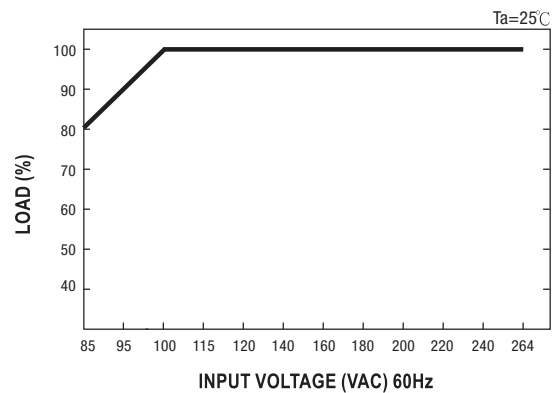

Note: All dimensions are in millimeters, to convert to inches multiply by 0.03937.



# PS-S60 Series Specifications



## Features:

- Universal AC input/full range
- Protections: Short Circuit / Overload / Overvoltage
- Cooling by free air convection
- DIN rail mountable
- LED indicator for power on
- No load power consumption < 0.75W
- 100% full load burn-in test
- 3 year warranty

## OUTPUT

Cat. No.	PS-S6005	PS-S6012	PS-S6024	PS-S6048
----------	----------	----------	----------	----------

DC VOLTAGE	5V	12V	24V	48V
RATED CURRENT	10A	5A	2.5A	1.25A
CURRENT RANGE	0 ~ 10A	0 ~ 5A	0 ~ 2.5A	0 ~ 1.25A
RATED POWER	50W	60W	60W	60W
RIPPLE & NOISE (max)	80mVp-p	120mVp-p	150mVp-p	200mVp-p
Ripple & noise are measured at 20MHz of bandwidth by using a 12 twisted pair-wire terminated with a 0.1µF & 47µF parallel capacitor				
VOLTAGE ADJ. RANGE	5 ~ 6V	12 ~ 15V	24 ~ 30V	48 ~ 56V
VOLTAGE TOLERANCE	±2.0%	±1.0%	±1.0%	±1.0%
Tolerance: includes set up tolerance, line regulation and load regulation.				
LINE REGULATION	±1.0%	±1.0%	±1.0%	±1.0%
LOAD REGULATION	±1.5%	±1.0%	±1.0%	±1.0%
SETUP, RISE TIME	500ms, 30ms/230VAC; 500ms, 30ms/115VAC at full load			
Length of set up time is measured at cold first start. Turning ON/OFF the power supply may lead to increase of the set up time.				
HOLD UP TIME (Typ.)	50ms/230VAC / 20ms/115VAC at full load			

## INPUT

VOLTAGE RANGE	85 ~ 264VAC	120 ~ 370VDC		
FREQUENCY RANGE	47~63Hz			
EFFICIENCY (Typ.)	78%	86%	88%	87%
AC CURRENT (max)	1.8A/115VAC; 1A/230VAC			
INRUSH CURRENT (Typ.)	COLD START: 30A/115VAC; 60A/230VAC			
LEAKAGE CURRENT	≤1mA/ 240VAC			

## PROTECTION

OVERLOAD PROTECTION	105% ~ 150% rated output power			
Protection type: Constant current limiting, recovers automatically after fault condition is removed				
OVERVOLTAGE PROTECTION	6.25 ~ 7.25V	15.6 ~ 18V	31.2 ~ 36V	57.6 ~ 64.8V
Protection type: Shut down overvoltage, re-power on to recover				
OVER TEMPERATURE PROTECTION	Power supply shut down at 70°C constant current limiting / output voltage goes to 0;			
re-power on to recover				
DC OK AKTIV SIGNAL (max.)	Relay contact rating (max.): 30V/1A resistive			

## ENVIRONMENT

WORKING TEMP.	-20 ~ +70°C (Refer to output load derating curve)			
WORKING HUMIDITY	20 ~ 90% RH non-condensing			
STORAGE TEMP., HUMIDITY	-40 ~ +85°C, 10 ~ 95% RH			
TEMP. COEFFICIENT	±0.03% °C (0 ~ 50°C)			
VIBRATION	Component: 10 ~ 500Hz, 2G 10min. / 1cycle, 60 min. each long X,Y, Z axes			
MOUNTING	Compliance to IEC60068-2-6			

## SAFETY & EMC

SAFETY STANDARDS	UL508 EN60950-1 compliant			
WITHSTAND VOLTAGE	I/P-O/P: 3KVAC I/P-FG: 1.5KVAC O/P-FG: 0.5KVAC			
ISOLATION RESISTANCE	I/P-O/P, I/P-FG, O/P-FG: ≥100M Ohms/500VDC (25°C; 70% RH)			
EMI CONDUCTION & RADIATION	Compliance to EN55011 EN55022 (CISPR22) EN61204-3 Class B			
HARMONIC CURRENT	Compliance to EN61000-3-2,-3			
EMS IMMUNITY	Compliance to EN61000-4-2,3,4,5,6,8,11; EN55024; ENV50204; EN61000-6-2; EN61204-3; light industry level; criteria A			
The power supply is considered a component which will be installed into a final equipment. The final equipment must be re-confirmed that it still meets EMC directives.				

## OTHERS

MTBF	299.2K hrs min. MIL-HDBK-217K (25°C)			
DIMENSION	40x90x100mm (WxHxD)			
PACKING	0.33Kg; 42pcs / 14.8Kg / 0.82CUFT			
All parameters NOT specially mentioned are measured at 230V AC input, rated load and 25°C of ambient temperature				

## Mechanical Specification

Terminal Pin. No Assign. (TB1)

Pin No.	Assignment
1	FG ⊕
2	AC/N
3	AC/L

Terminal Pin. No Assign. (TB2)

Pin No.	Assignment
1,2	DC OUTPUT +V
3,4	DC OUTPUT -V
5,6	DC OK RELAY CONTACT

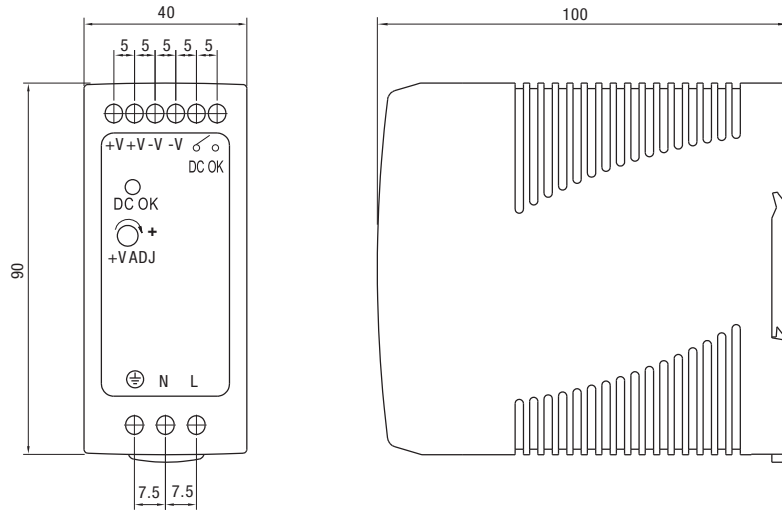

## Block Diagram

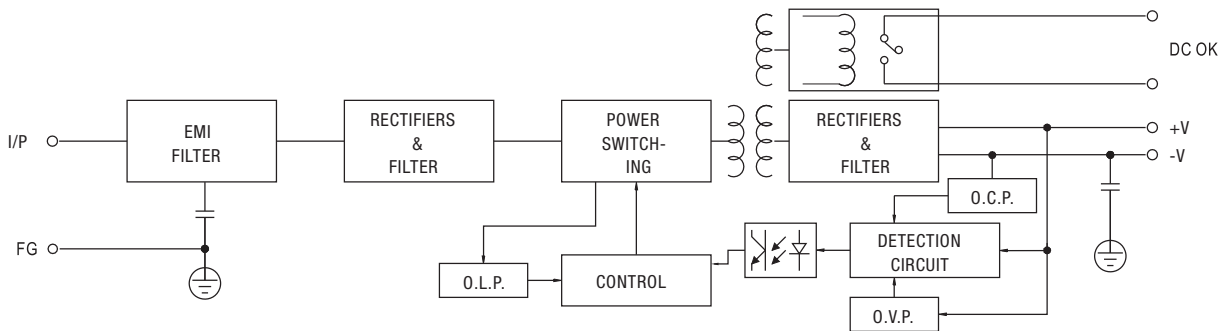

## DC OK Relay Contact

Contact Close	When the output voltage reaches the adjusted output voltage.
Contact Open	When the output voltage drop more than 90% output voltage.
Contact Ratings (max.)	30V/1A resistive load

## Derating Curve

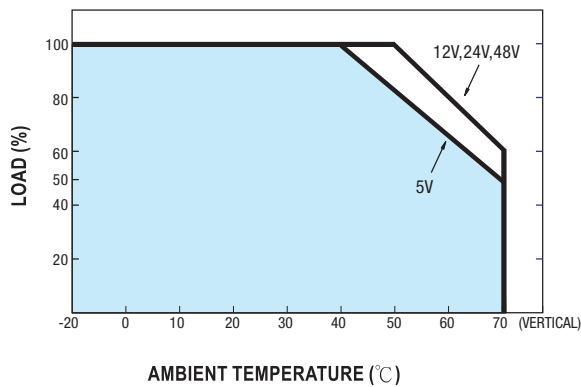

## Output Derating VS Input Voltage

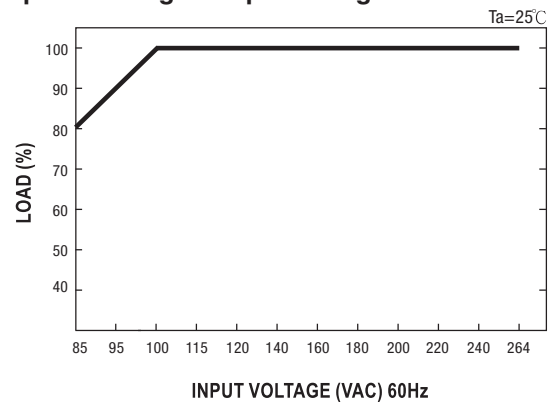

Note: All dimensions are in millimeters, to convert to inches multiply by 0.03937.



# PS-S100 Series Specifications



## Features:

- Universal AC input / full range
- Protections: Short Circuit / Overload / Overvoltage / Over temperature
- ZCS/ZVS technology to reduce power dissipation
- Cooling by free air convection
- DIN rail mountable
- DC OK relay contact
- No load power consumption < 1W
- LED indicator for power on
- 100% full load burn-in test
- 3 year warranty

## OUTPUT

Cat. No.	PS-S10012	PS-S10024	PS-S10048
----------	-----------	-----------	-----------

DC VOLTAGE	12V	24V	48V
RATED CURRENT	7.5A	4A	2A
CURRENT RANGE	0 ~ 7.5A	0 ~ 4A	0 ~ 2A
RATED POWER	90W	96W	96W
RIPPLE & NOISE (max)	120mVp-p	150mVp-p	200mVp-p
Ripple & noise are measured at 20MHz of bandwidth by using a 12 twisted pair-wire terminated with a 0.1µF & 47µF parallel capacitor.			
VOLTAGE ADJ. RANGE	12 ~ 15V	24 ~ 30V	48 ~ 56V
VOLTAGE TOLERANCE	±1.0%	±1.0%	±1.0%
Tolerance: includes set up tolerance, line regulation and load regulation.			
LINE REGULATION	±1.0%	±1.0%	±1.0%
LOAD REGULATION	±1.0%	±1.0%	±1.0%
SETUP, RISE TIME	3000ms, 50ms/230VAC; 3000ms, 50ms/115VAC at full load		
Length of set up time is measured at cold first start. Turning ON/OFF the power supply may lead to increase of the set up time.			
HOLD UP TIME (Typ.)	50ms/230VAC; 20ms/115VAC at full load		

## INPUT

VOLTAGE RANGE	85 ~ 264VAC 120 ~ 370VDC
Derating maybe needed under low input voltages, please check the derating curve for more detail	
FREQUENCY RANGE	47~63Hz
POWER FACTOR (Typ.)	PF ≥ 0.95/230VAC; PF ≥ 0.98/115VAC at full load
EFFICIENCY (Typ.)	85%   86%   88%
AC CURRENT (max)	1.3A/115VAC; 0.8A/230VAC
INRUSH CURRENT (Typ.)	COLD START: 30A/115VAC; 60A/230VAC
LEAKAGE CURRENT	≤1mA/ 240VAC

## PROTECTION

OVERLOAD	105% ~ 150% rated output power
Protection type: Constant current limiting, recovers automatically after fault condition is removed	
OVERVOLTAGE	15.6 ~ 18V   31.2 ~ 36V   57.6 ~ 64.8V
Protection type: Shut down overvoltage, re-power on to recover	
OVERTEMPERATURE	90°C ± 10°C (RTH2) detect on heat sink of power transistor
Protection type: Shut down overvoltage, re-power on to recover	
SHORT CIRCUIT PROTECTION	Power supply shut down at 70°C constant current limiting / output voltage goes to 0; re-power on to recover
DC OK AKTIV SIGNAL (max.)	Relay contact rating (max.): 30V/1A resistive

## ENVIRONMENT

WORKING TEMP.	-10 ~ +60°C (Refer to output load derating curve)
WORKING HUMIDITY	20 ~ 90% RH non-condensing
STORAGE TEMP., HUMIDITY	-40 ~ +85°C, 10 ~ 95% RH
TEMP. COEFFICIENT	±0.03% /°C (0 ~ 50°C)
VIBRATION	Component: 10 ~ 500Hz, 2G 10min. / 1cycle, 60 min. each long X,Y, Z axes
MOUNTING	Compliance to IEC60068-2-6

## SAFETY & EMC

SAFETY STANDARDS	UL508 EN60950-1 compliant
WITHSTAND VOLTAGE	I/P-O/P: 3KVAC I/P-FG:1.5KVAC O/P-FG:0.5KVAC
ISOLATION RESISTANCE	I/P-O/P, I/P-FG, O/P-FG: ≥100M Ohms/500VDC/25°C/70% RH
EMI CONDUCTION & RADIATION	Compliance to EN55011 EN55022 (CISPR22) EN61204-3 Class B
HARMONIC CURRENT	Compliance to EN61000-3-2,-3
EMS IMMUNITY	Compliance to EN61000-4-2,3,4,5,6,8,11; EN55024; ENV50204; EN61000-6-2; EN61204-3; light industry level; criteria A
The power supply is considered a component which will be installed into a final equipment. The final equipment must be re-confirmed that it still meets EMC directives.	

## OTHERS

MTBF	346K hrs min. MIL-HDBK-217K (25°C)
DIMENSION	55x90x100mm (WxHxD)
PACKING	0.42Kg; 30pcs / 13.6Kg / 0.82CUFT
All parameters NOT specially mentioned are measured at 230V AC input, rated load and 25°C of ambient temperature.	



## Mechanical Specification

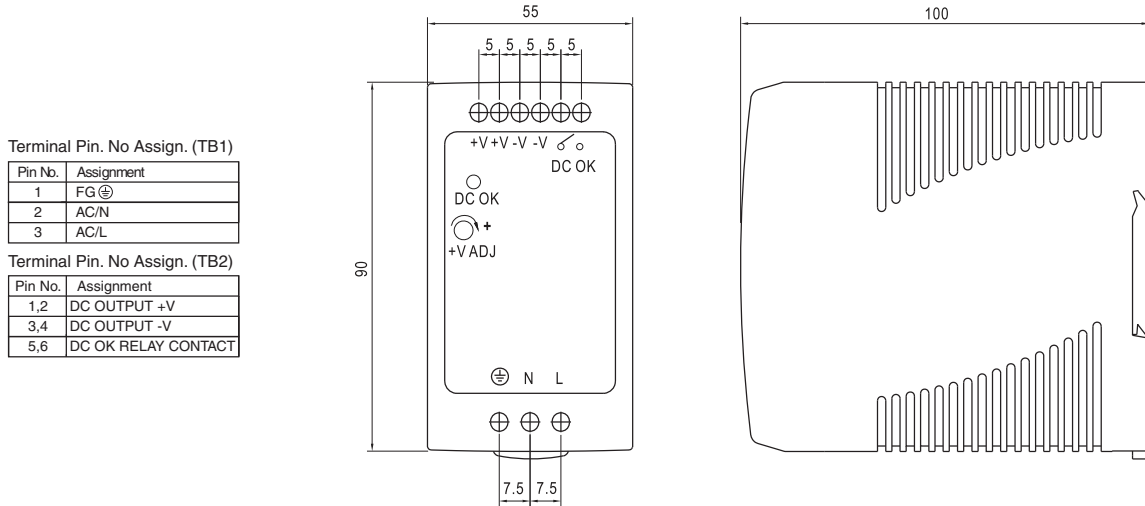

## Block Diagram

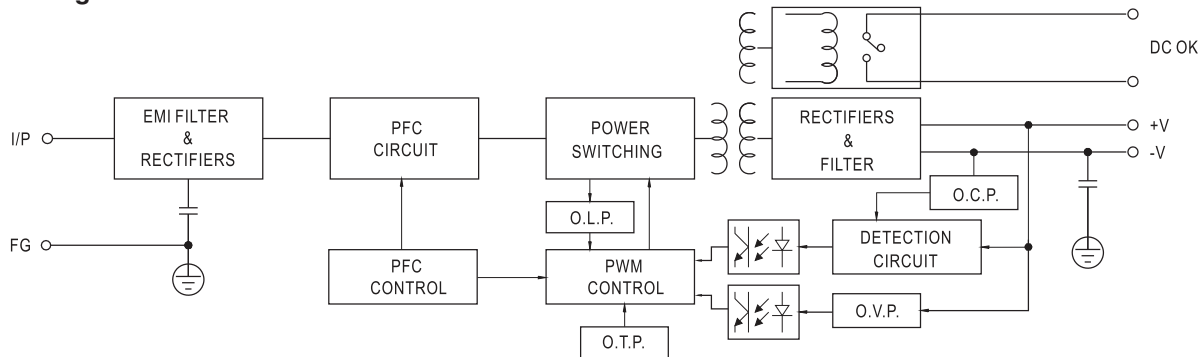

## DC OK Relay Contact

Contact Close	When the output voltage reaches the adjusted output voltage.
Contact Open	When the output voltage drop below 90% output voltage.
Contact Ratings (max.)	30V/1A resistive load

## Derating Curve

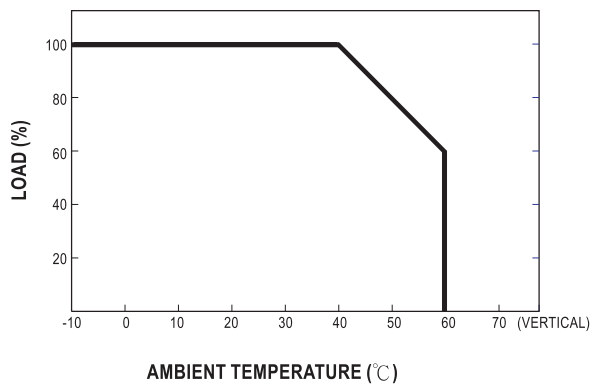

## Output Derating VS Input Voltage

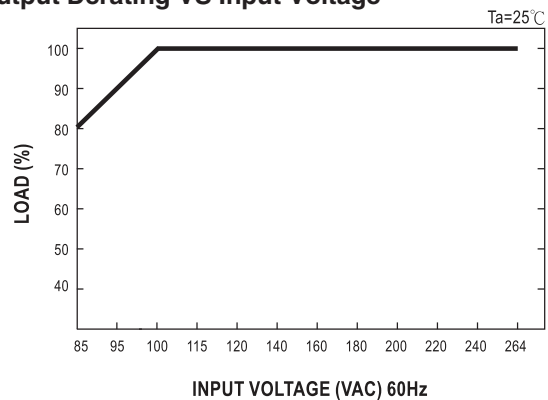

Note: All dimensions are in millimeters, to convert to inches multiply by 0.03937.



## Low Profile Single Phase Power Supply (Class II)

The Low Profile Single Phase Power Supplies are 15W to 100W single output Class II DIN rail switching power supplies. They are designed for the fast growing demand of the DIN rail application with limited enclosure height. With Class II of protection level, low profile series provide users a safer operating environment since the whole plastic case is free from hazardous leakage current. Featuring up to 89% of high efficiency, this series can be cooled by only free air convection that significantly increase the reliability and lifetime of the power supply. Complying with the safety of the UL508 and EMC requirements of EN50178 which is mainly for power distribution aspects, the low profile switching power supplies are suitable to be installed in a power distribution box or a control cabinet and the major application fields are building automation and household appliance control.

- Input voltage range: 85 - 264V AC; 120-370V DC
- AC inrush current: Cold start: 15A at 115V AC, 30A at 230V DC (PS-30xx)
- DC adjustment range:  $\pm 10\%$  rated output voltage
- Overload protection: 105% - 160% constant current limiting, auto-recovery
- Over-voltage protection: 115% - 135% rated output voltage
- Setup, rise, hold up time: 100ms, 30ms, 100ms at full load and 230V AC (PS-30xx)
- Withstand voltage: I/P-O/P:3KV AC, I/P-FG:1.5KV AC
- Working temperature: -20 to +50°C (-4° to +122°F) at 100%  
and +60°C (+140°F) at 80% load
- Safety standards: UL60950-1, UL508
- EMC standards: EN55022 class B  
EN61000-4-2,3,4,5,6,8,11  
ENV50204  
EN61204-3
- Military Standard: MIL-HDBK-217K

# PS Series - Low Profile



## Features:

- Universal AC input/Full range
- Protections: Short circuit / Overload / Overvoltage
- Cooling by free air convection
- DIN rail mountable
- Isolation class II
- LED indicator for power on
- 100% full load burn-in test
- 3 year warranty

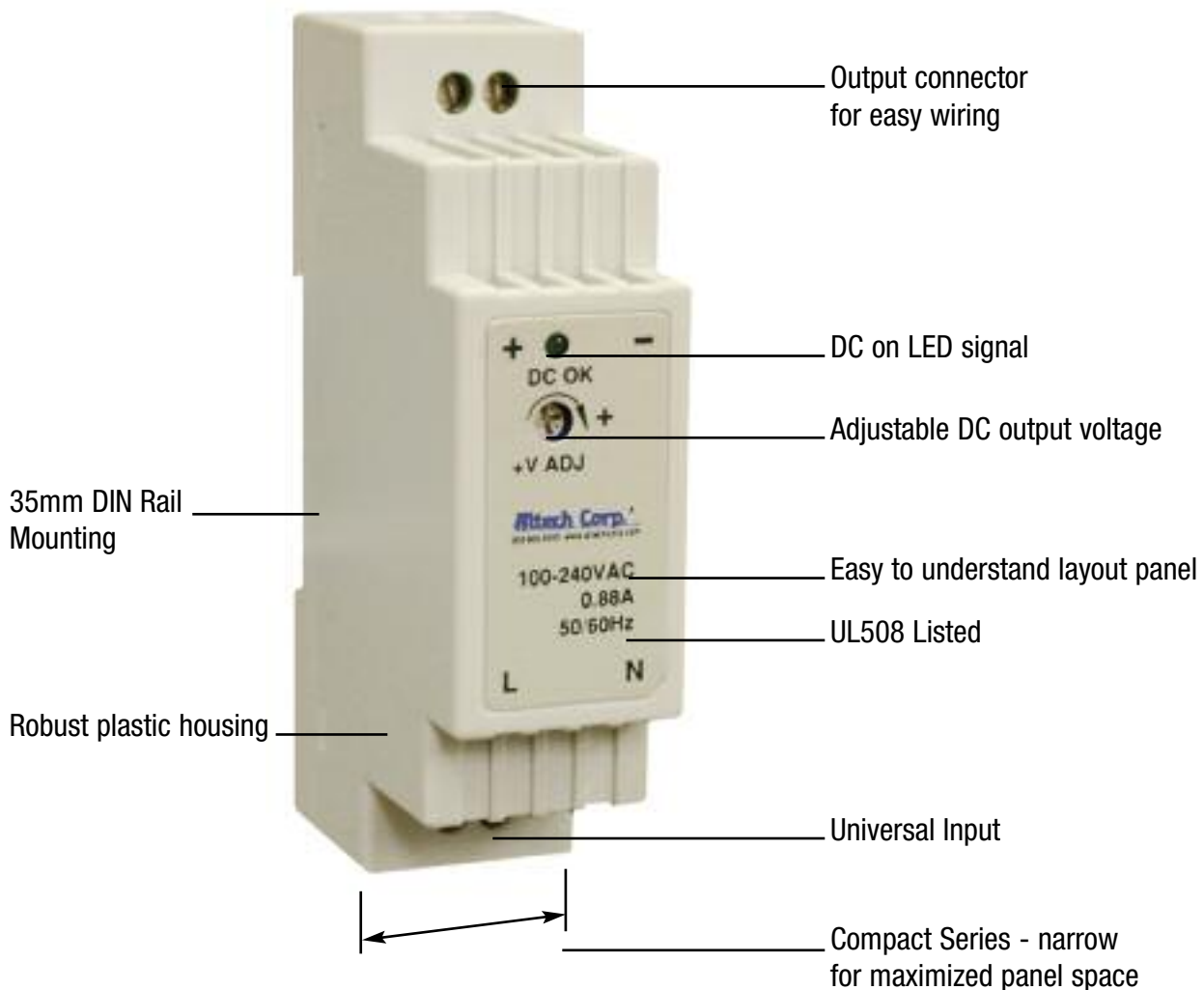

# 15-100W Low Profile POWER SUPPLIES



## 15W Single Output Class II DIN Rail Power Supply



Cat. No.	Output		Tol. %	Ripple & Noise	Efficiency	NOTES
	V DC	A				
PS-1505	5V DC	2.4A	±2%	80 mVp-p	77%	
PS-1512	12V DC	1.25A	±1%	120 mVp-p	84%	
PS-1515	15V DC	1A	±1%	120 mVp-p	83.5%	
PS-1524	24V DC	0.63A	±1%	150 mVp-p	85%	



## 30W Single Output Class II DIN Rail Power Supply

Cat. No.	Output		Tol. %	Ripple & Noise	Efficiency	NOTES
	V DC	A				
PS-3005	5V DC	3A	±2%	80 mVp-p	74%	
PS-3012	12V DC	2A	±1%	120 mVp-p	81%	
PS-3015	15V DC	2A	±1%	120 mVp-p	82%	
PS-3024	24V DC	1.5A	±1%	150 mVp-p	83%	

## 45W Single Output Class II DIN Rail Power Supply



Cat. No.	Output		Tol. %	Ripple & Noise	Efficiency	NOTES
	V DC	A				
PS-4505	5V DC	5A	±2%	100 mVp-p	72%	
PS-4512	12V DC	3.5A	±1%	200 mVp-p	77%	
PS-4515	15V DC	2.8A	±1%	240 mVp-p	77%	
PS-4524	24V DC	2A	±1%	480 mVp-p	80%	

## 60W Single Output Class II DIN Rail Power Supply



Cat. No.	Output		Tol. %	Ripple & Noise	Efficiency	NOTES
	V DC	A				
PS-6005	5V DC	6.5A	±2%	80 mVp-p	76%	
PS-6012	12V DC	4.5A	±1%	120 mVp-p	82%	
PS-6015	15V DC	4.0A	±1%	120 mVp-p	83%	
PS-6024	24V DC	2.5A	±1%	150 mVp-p	84%	

## 100W Single Output Class II DIN Rail Power Supply



Cat. No.	Output		Tol. %	Ripple & Noise	Efficiency	NOTES
	V DC	A				
PS-10012	12V DC	7.5A	±2%	120 mVp-p	87%	
PS-10015	15V DC	6.5A	±1%	120 mVp-p	87%	
PS-10024	24V DC	4.2A	±1%	150 mVp-p	89%	

# SPECIFICATIONS

## PS-15 Series

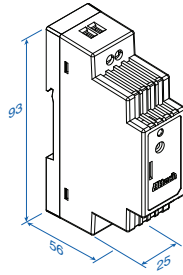

### Terminal Pin. No Assignment

Pin No.	Assignment	Pin No.	Assignment
1	AC/L	3	-V
2	AC/N	4	+V

Universal Input: 85-264V AC, 120-370V DC full range;  
0.88A @ 115V AC; 0.48A @ 230V AC

Connection: Input - 2 poles, Output - 2 poles, single screw terminal  
Size (WxHxD): 25x93x56mm (0.98x3.66x2.20 inches)

Packaging: 1/box; 0.22lbs / 0.1Kg

## PS-30 Series

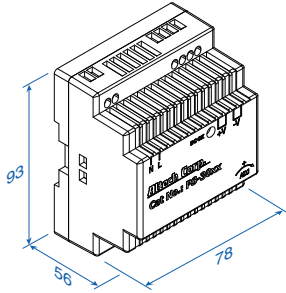

### Terminal Pin. No Assignment

Pin No.	Assignment	Pin No.	Assignment
1	AC/L	5,6	-V
2	AC/N	7	LED
3,4	+V	8	+V ADJ.

Universal Input: 85-264V AC, 120-370V DC full range;  
0.88A @ 115V AC; 0.48A @ 230V AC

Connection: Input - 2 poles, Output - 2 poles, double screw terminal  
Size (WxHxD): 78x93x56mm (3.07x3.66x2.20 inches)

Packaging: 1/box; 0.60lbs / 0.27Kg

## PS-45 Series

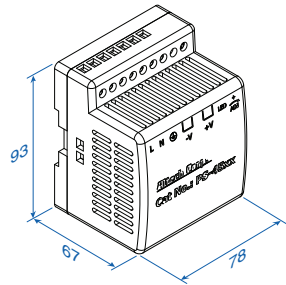

### Terminal Pin. No Assignment

Pin	Assignment	Pin	Assignment
1	AC/L	6,7	DC OUTPUT+V
2	AC/N	8	LED
3	FG ⊕	9	+V ADJ.
4,5	DC OUTPUT-V		

Universal Input: 85-264V AC, 120-370V DC full range;  
1.5A @ 115V AC, 0.75A @ 230V AC

Connection: Input - 3 poles, Output - 2 poles, double screw terminal  
Size (WxHxD): 78x93x67mm (3.07x3.66x2.64 inches)

Packaging: 1/box; 0.68lbs / 0.31Kg

## PS-60 Series

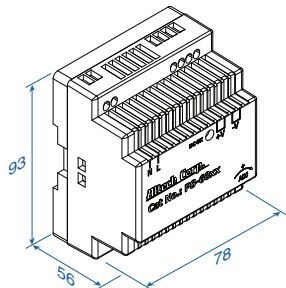

### Terminal Pin. No Assignment

Pin No.	Assignment	Pin No.	Assignment
1	AC/L	5,6	-V
2	AC/N	7	LED
3,4	+V	8	+V ADJ.

Universal Input: 88-264V AC, 124-370V DC full range;  
1.2A @ 115V AC, 0.8A @ 230V AC

Connection: Input - 2 poles, Output - 2 poles, double screw terminal  
Size (WxHxD): 78x93x56mm (3.07x3.66x2.20 inches)

Packaging: 1/box; 0.66lbs / 0.30Kg

## PS-100 Series

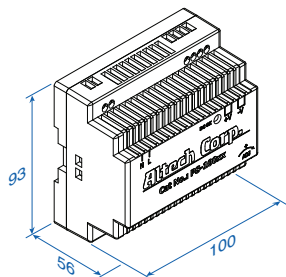

### Terminal Pin. No Assignment

Pin No.	Assignment	Pin No.	Assignment
1	AC/L	5,6	-V
2	AC/N	7	LED
3,4	+V	8	+V ADJ.

Universal Input: 88-264V AC, 124-370V DC full range;  
3A @ 115V AC, 1.6A @ 230V AC

Connection: Input - 2 poles, Output - 2 poles, double screw terminal  
Size (WxHxD): 100x93x56mm (3.94x3.66x2.20 inches)

Packaging: 1/box; 0.77lbs / 0.35Kg

*Note: All dimensions are in millimeters, to convert to inches multiply by 0.03937.*



# PS-15 Series Specifications



## Features:

- Universal AC input / full range
- Protections: Short Circuit / Overload / Over Voltage
- Cooling by free air convection
- DIN rail mountable
- Isolation class II
- LED indicator for power on
- No load power consumption <0.5W
- 100% full load burn-in test
- 3 year warranty

## OUTPUT

Cat. No.	PS-1505	PS-1512	PS-1515	PS-1524
----------	---------	---------	---------	---------

DC VOLTAGE	5V	12V	15V	24V
RATED CURRENT	2.4A	1.25A	1A	0.63A
CURRENT RANGE	0 ~ 2.4A	0 ~ 1.25A	0 ~ 1A	0 ~ 0.63A
RATED POWER	12W	15W	15W	15.2W
RIPPLE & NOISE (max)	80mVp-p	120mVp-p	120mVp-p	150mVp-p
<small>Ripple &amp; noise are measured at 20MHz of bandwidth by using a 12 twisted pair-wire terminated with a 0.1µF &amp; 47µF parallel capacitor</small>				
VOLTAGE ADJ. RANGE	4.75 ~ 5.5V	10.8 ~ 13.2V	13.5 ~ 16.5V	21.6 ~ 26.4V
VOLTAGE TOLERANCE	±2.0%	±1.0%	±1.0%	±1.0%
<small>Tolerance: includes set up tolerance, line regulation and load regulation.</small>				
LINE REGULATION	±1.0%	±1.0%	±1.0%	±1.0%
LOAD REGULATION	±1.0%	±1.0%	±1.0%	±1.0%
SETUP, RISE TIME	1000ms, 50ms / 230VAC	1000ms, 50ms / 115VAC at full load		
HOLD UP TIME (Typ.)	70ms / 230VAC	16ms / 115VAC at full load		

## INPUT

VOLTAGE RANGE	85 ~ 264VAC	120 ~ 370VDC		
FREQUENCY RANGE	47 ~ 63Hz			
EFFICIENCY (Typ.)	77%	84%	83.50%	85%
AC CURRENT (max.)	0.88A / 115VAC	0.48A / 230VAC		
INRUSH CURRENT (Typ.)	COLD START 35A / 115VAC	65A / 230VAC		

## PROTECTION

OVERLOAD	105 ~ 160% rated output power <small>Protection type: Constant current limiting recovers automatically after fault condition is removed (Hiccup mode) Constant current operation region is within 60 ~ 100% rated output voltage.</small>			
OVERVOLTAGE	5.75 ~ 6.75V	13.8 ~ 16.2V	17.25 ~ 20.25V	27.6 ~ 32.4V
<small>Protection type: Shut down overvoltage, clamping by zener diode</small>				

## ENVIRONMENT

WORKING TEMP.	-20 ~ +60°C (Refer to output load derating curve)			
WORKING HUMIDITY	20 ~ 90% RH non-condensing			
STORAGE TEMP., HUMIDITY	-40 ~ +85°C, 10 ~ 95% RH			
TEMP. COEFFICIENT	±0.03% °C (0 ~ 50°C)			
VIBRATION	Component: 10 ~ 500Hz, 2G 10min. / 1cycle, 60 min. each long X,Y, Z axes			
MOUNTING	Compliance to IEC60068-2-6			

## SAFETY & EMC

SAFETY STANDARDS	UL60950-1 EN60950-1 compliant Design refer to EN50178			
WITHSTAND VOLTAGE	I/P-O/P: 3KVAC			
ISOLATION RESISTANCE	I/P-O/P: 100M Ohms/500VDC (25°C; 70% RH)			
EMI CONDUCTION & RADIATION	Compliance to EN55011 EN55022 (CISPR22); EN61204-3 Class B			
HARMONIC CURRENT	Compliance to EN61000-3-2,-3			
EMS IMMUNITY	Compliance to EN61000-4-2,3,4,5,6,8,11; EN55024; ENV50204; EN61000-6-2; EN61204-3; heavy industry level; criteria A  The power supply is considered a component which will installed into a final equipment. The final equipment must be re-confirmed that it still meets EMC directives.			

## OTHERS

MTBF	1172.3K hrs min. MIL-HDBK-217K (25°C)			
DIMENSION	25x93x56mm (WxHxD)			
PACKING	0.1Kg; 140pcs / 15Kg / 0.92CUFT			
<small>All parameters NOT specially mentioned are measured at 230V AC input, rated load and 25°C of ambient temperature</small>				



## Mechanical Specification

Terminal Pin. No Assignment

Pin No.	Assignment	Pin No.	Assignment
1	AC/L	3	-V
2	AC/N	4	+V

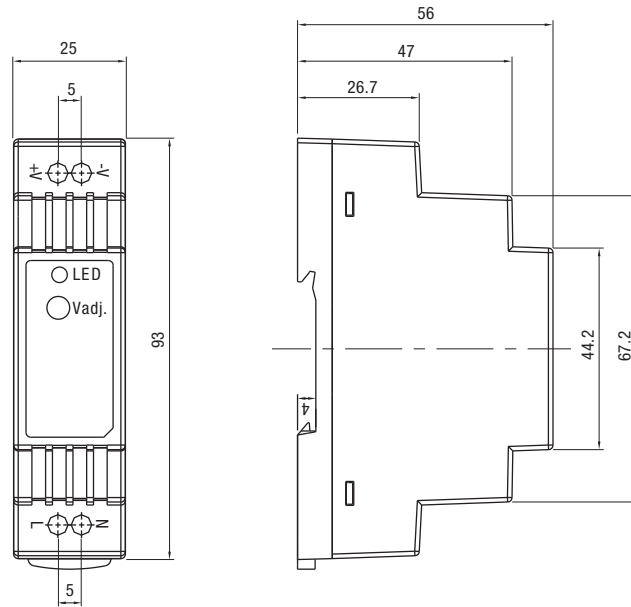

## Block Diagram

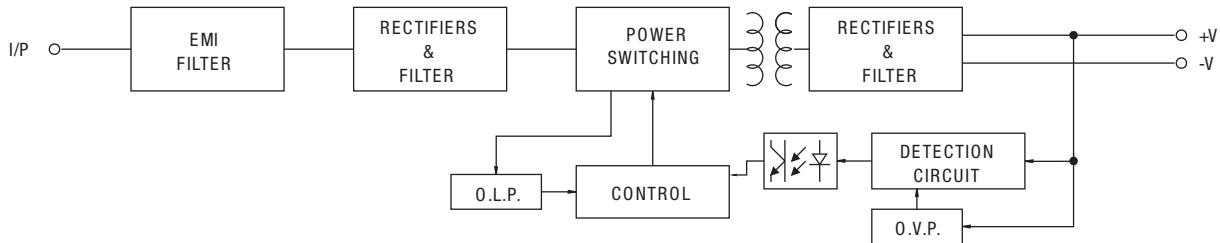

## Derating Curve

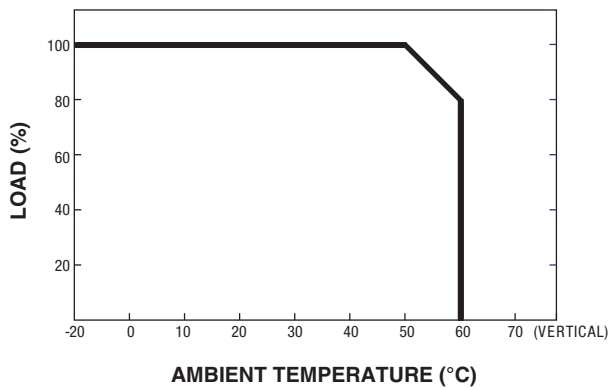

## Output Derating VS Input Voltage

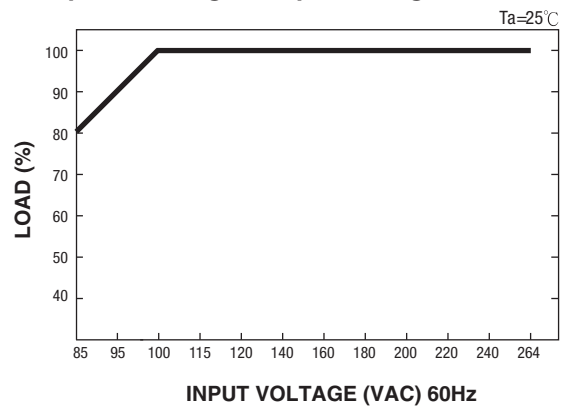

Note: All dimensions are in millimeters, to convert to inches multiply by 0.03937.



# PS-30 Series Specifications



## Features:

- Universal AC input/ full range
- Protections: Short Circuit / Overload / Over Voltage
- Cooling by free air convection
- DIN rail mountable
- Isolation class II
- LED indicator for power on
- 100% full load burn-in test
- 3 year warranty

## OUTPUT

Cat. No.	PS-3005	PS-3012	PS-3015	PS-3024
----------	---------	---------	---------	---------

DC VOLTAGE	5V	12V	15V	24V
RATED CURRENT	3A	2A	2A	1.5A
CURRENT RANGE	0 ~ 3A	0 ~ 2A	0 ~ 2A	0 ~ 1.5A
RATED POWER	15W	24W	30W	36W
RIPPLE & NOISE (max)	80mVp-p	120mVp-p	120mVp-p	150mVp-p
<small>Ripple &amp; noise are measured at 20MHz of bandwidth by using a 12 twisted pair-wire terminated with a 0.1µF &amp; 47µF parallel capacitor</small>				
VOLTAGE ADJ. RANGE	4.75 ~ 5.5V	10.8 ~ 13.2V	13.5 ~ 16.5V	21.6 ~ 26.4V
VOLTAGE TOLERANCE	±2.0%	±1.0%	±1.0%	±1.0%
<small>Tolerance: includes set up tolerance, line regulation and load regulation.</small>				
LINE REGULATION	±1.0%	±1.0%	±1.0%	±1.0%
LOAD REGULATION	±1.0%	±1.0%	±1.0%	±1.0%
SETUP, RISE TIME	100ms, 30ms / 230VAC	100ms, 30ms / 115VAC at full load		
HOLD UP TIME (Typ.)	100ms / 230VAC	21ms / 115VAC at full load		

## INPUT

VOLTAGE RANGE	85 ~ 264VAC	120 ~ 370VDC		
FREQUENCY RANGE	47 ~ 63Hz			
EFFICIENCY (Typ.)	74%	81%	82%	83%
AC CURRENT (Typ.)	0.88A / 115VAC	0.48A / 230VAC		
INRUSH CURRENT (Typ.)	COLD START 15A / 115VAC; 30A / 230VAC			

## PROTECTION

OVERLOAD	105 ~ 160% rated output power			
<small>Protection type: Constant current limiting recovers automatically after fault condition is removed</small>				
OVERVOLTAGE	5.75 ~ 6.75V	13.8 ~ 16.2V	17.25 ~ 20.25V	27.6 ~ 32.4V
<small>Protection type: Shut down overvoltage, clamping by zener diode</small>				

## ENVIRONMENT

WORKING TEMP.	-20 ~ +60°C (Refer to output load derating curve)			
WORKING HUMIDITY	20 ~ 90% RH non-condensing			
STORAGE TEMP., HUMIDITY	-40 ~ +85°C, 10 ~ 95% RH			
TEMP. COEFFICIENT	±0.03% / °C (0 ~ 50°C)			
VIBRATION	Component: 10 ~ 500Hz, 2G 10min. / 1cycle, 60 min. each long X,Y, Z axes			
MOUNTING	Compliance to IEC60068-2-6			

## SAFETY & EMC

SAFETY STANDARDS	UL60950-1 EN60950-1 compliant Design refer to EN50178			
WITHSTAND VOLTAGE	I/P-O/P: 3KVAC			
ISOLATION RESISTANCE	I/P-O/P: 100M Ohms / 500VDC			
EMI CONDUCTION & RADIATION	Compliance to EN55011 EN55022 (CISPR22) Class B			
HARMONIC CURRENT	Compliance to EN61000-3-2,-3			
EMS IMMUNITY	Compliance to EN61000-4-2,3,4,5,6,8,11; EN55024; ENV50204; EN61000-6-2; EN61204-3; heavy industry level; criteria A			
<small>The power supply is considered a component which will installed into a final equipment. The final equipment must be re-confirmed that it still meets EMC directives.</small>				

## OTHERS

MTBF	441.5K hrs min. MIL-HDBK-217K (25°C)			
DIMENSION	78x93x56mm (WxHxD)			
PACKING	0.27Kg; 48pcs / 14Kg / 1.02CUFT			
<small>All parameters NOT specially mentioned are measured at 230V AC input, rated load and 25°C of ambient temperature</small>				

## Mechanical Specification

Terminal Pin. No Assignment

Pin No.	Assignment	Pin No.	Assignment
1	AC/L	5,6	-V
2	AC/N	7	LED
3,4	+V	8	+V ADJ.

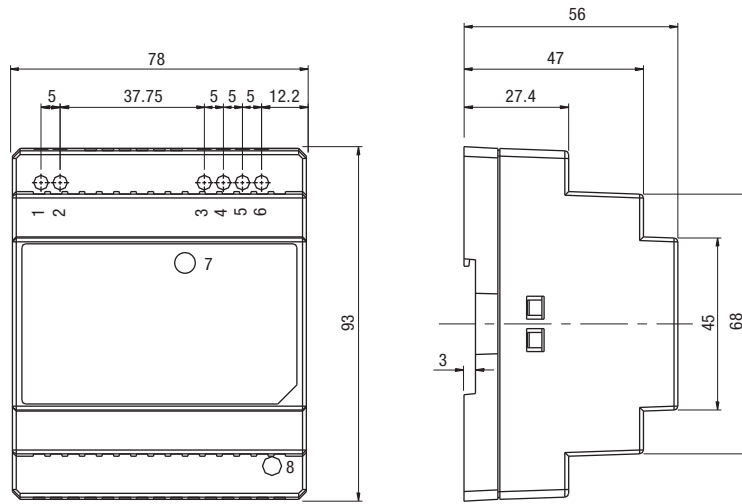

## Block Diagram

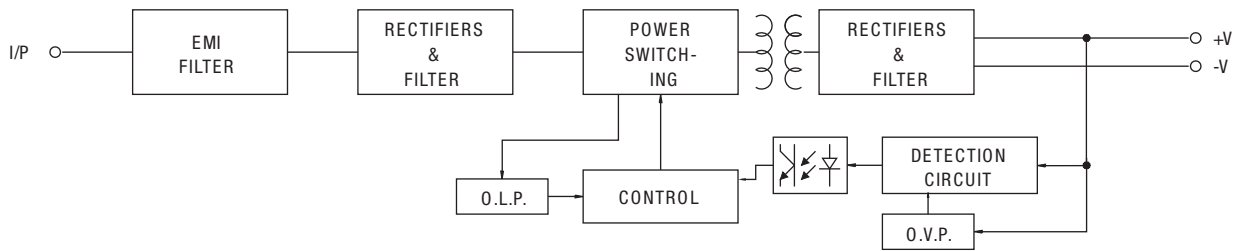

## Derating Curve

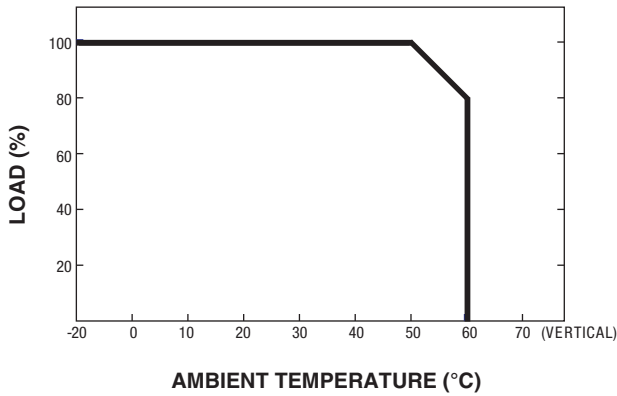

## Output Derating VS Input Voltage

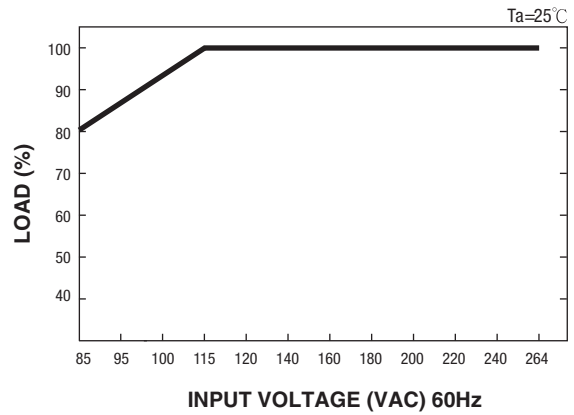

Note: All dimensions are in millimeters, to convert to inches multiply by 0.03937.



# PS-45 Series Specifications



## Features:

- Universal AC input / full range
- Protections: Short Circuit / Overload / Over Voltage/ Overtemperature
- Cooling by free air convection
- DIN rail mountable
- UL508 approved
- LED indicator for power on
- Fix switching frequency at 100kHz
- 100% full load burn-in test
- 3 year warranty

## OUTPUT

Cat. No.	PS-4505	PS-4512	PS-4515	PS-4524
----------	---------	---------	---------	---------

DC VOLTAGE	5V	12V	15V	24V
RATED CURRENT	5A	3.5A	2.8A	2A
CURRENT RANGE	0 ~ 5A	0 ~ 3.5A	0 ~ 2.8A	0 ~ 2A
RATED POWER	25W	42W	42W	48W
RIPPLE & NOISE (max)	100mVp-p	200mVp-p	240mVp-p	480mVp-p

Ripple & noise are measured at 20MHz of bandwidth by using a 12 twisted pair-wire terminated with a 0.1µF & 47µF parallel capacitor

VOLTAGE ADJ. RANGE	4.75 ~ 5.5V	10.8 ~ 13.2V	13.5 ~ 16.5V	21.6 ~ 26.4V
VOLTAGE TOLERANCE	±2.0%	±1.0%	±1.0%	±1.0%

Tolerance: includes set up tolerance, line regulation and load regulation.

LINE REGULATION	±1.0%	±1.0%	±1.0%	±1.0%
LOAD REGULATION	±1.0%	±1.0%	±1.0%	±1.0%
SETUP, RISE TIME	800ms, 60ms / 230VAC at full load			
HOLD UP TIME (Typ.)	60ms / 230VAC at full load			

## INPUT

VOLTAGE RANGE	85 ~ 264VAC	120 ~ 370VDC		
FREQUENCY RANGE	47 ~ 63Hz			
EFFICIENCY (Typ.)	72%	77%	77%	80%
AC CURRENT (max.)	1.5A / 115VAC	0.75A / 230VAC		
INRUSH CURRENT (Typ.)	COLD START 28A / 115VAC; 56A / 230VAC			
LEAKAGE CURRENT	≤1mA / 240VAC			

## PROTECTION

OVERLOAD	105 ~ 160% rated output power Protection type: Constant current limiting recovers automatically after fault condition is removed			
OVERVOLTAGE	5.75 ~ 6.75V	13.8 ~ 16.2V	17.25 ~ 20.25V	27.6 ~ 32.4V
OVERTEMPERATURE	Tj 135°C typically (U1) detect on heat sink of power transistor Protection type: Shut down overvoltage, clamping by zener diode Protection type: Shut down overvoltage, re-power on to recover			

## ENVIRONMENT

WORKING TEMPERATURE	-10 ~ +50°C (Refer to output load derating curve)
WORKING HUMIDITY	20 ~ 90% RH non-condensing
STORAGE TEMP., HUMIDITY	-20 ~ +85°C, 10 ~ 95% RH
TEMP. COEFFICIENT	±0.03% / °C (0 ~ 50°C)
VIBRATION	Component: 10 ~ 500Hz, 2G 10min. / 1cycle, 60 min. each long X,Y, Z axes
MOUNTING	Compliance to IEC60068-2-6

## SAFETY & EMC

SAFETY STANDARDS	UL508 EN60950-1 compliant
WITHSTAND VOLTAGE	I/P-O/P: 3KVAC I/P-FG:1.5KVAC O/P-FG:0.5KVAC
ISOLATION RESISTANCE	I/P-O/P, I/P-FG, O/P-FG: 100M Ohms / 500VDC (25°C; 70% RH)
EMI CONDUCTION & RADIATION	Compliance to EN55011; EN55022 (CISPR22) Class B
HARMONIC CURRENT	Compliance to EN61000-3-2,-3
EMS IMMUNITY	Compliance to EN61000-4-2,3,4,5,6,8,11; ENV50204; EN55024; EN61000-6-2; heavy industry level; criteria A
	The power supply is considered a component which will installed into a final equipment. The final equipment must be re-confirmed that it still meets EMC directives.

## OTHERS

MTBF	364.6K hrs min. MIL-HDBK-217K (25°C)
DIMENSION	93x78x67mm (LxWxH)
PACKING	0.31Kg; 48pcs / 16.1Kg / 1.3CUFT

All parameters NOT specially mentioned are measured at 230V AC input, rated load and 25°C of ambient temperature

## Mechanical Specification

Terminal Pin. No Assignment

Pin	Assignment	Pin	Assignment
1	AC/L	6,7	DC OUTPUT+V
2	AC/N	8	LED
3	FG ⊕	9	+V ADJ.
4,5	DC OUTPUT-V		

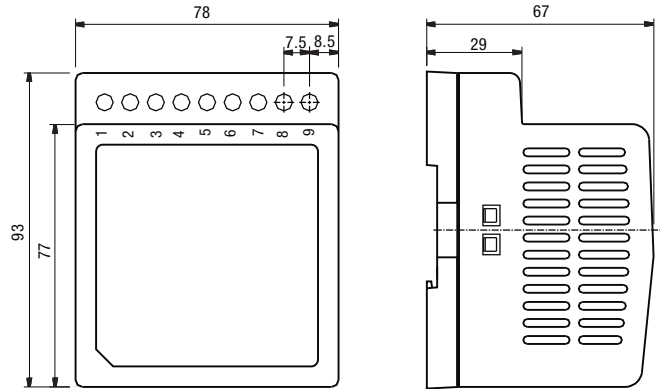

## Block Diagram

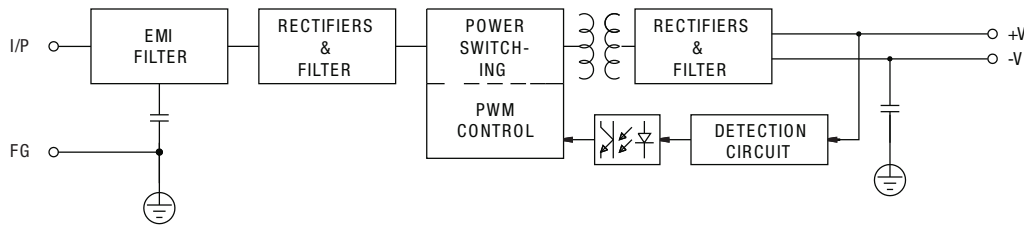

## Derating Curve

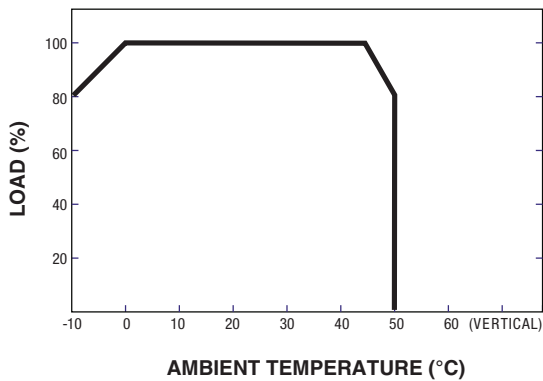

## Static Characteristic (24V)

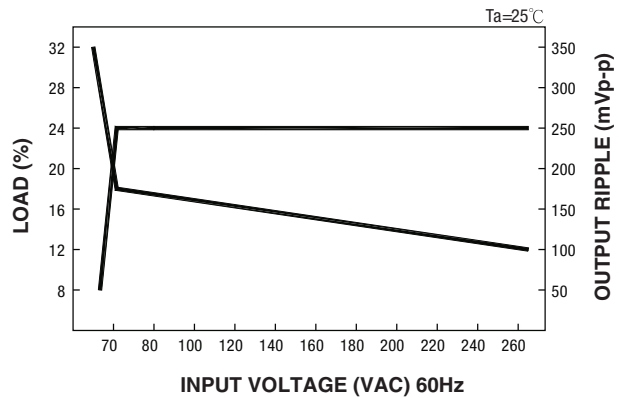

Note: All dimensions are in millimeters, to convert to inches multiply by 0.03937.



# PS-60 Series Specifications



## Features:

- Universal AC input / full range
- Protections: Short Circuit / Overload / Over Voltage
- Cooling by free air convection
- DIN rail mountable
- Isolation class II
- LED indicator for power on
- 100% full load burn-in test
- 3 year warranty

## OUTPUT

Cat. No.	PS-6005	PS-6012	PS-6015	PS-6024
----------	---------	---------	---------	---------

DC VOLTAGE	5V	12V	15V	24V
RATED CURRENT	6.5A	4.5A	4A	2.5A
CURRENT RANGE	0 ~ 6.5A	0 ~ 4.5A	0 ~ 4A	0 ~ 2.5A
RATED POWER	32.5W	54W	60W	60W
RIPPLE & NOISE (max)	80mVp-p	120mVp-p	120mVp-p	150mVp-p

Ripple & noise are measured at 20MHz of bandwidth by using a 12 twisted pair-wire terminated with a 0.1µF & 47µF parallel capacitor

VOLTAGE ADJ. RANGE	4.75 ~ 5.5V	11.1 ~ 13.2V	13.5 ~ 16.5V	21.6 ~ 26.4V
VOLTAGE TOLERANCE	±2.0%	±1.0%	±1.0%	±1.0%

Tolerance: includes set up tolerance, line regulation and load regulation.

LINE REGULATION	±1.0%	±1.0%	±1.0%	±1.0%
LOAD REGULATION	±1.0%	±1.0%	±1.0%	±1.0%
SETUP, RISE TIME	100ms, 30ms / 230VAC	200ms, 30ms / 115VAC at full load		
HOLD UP TIME (Typ.)	100ms / 230VAC	23ms / 115VAC at full load		

## INPUT

VOLTAGE RANGE	85 ~ 264VAC	124 ~ 370VDC		
FREQUENCY RANGE	47 ~ 63Hz			
EFFICIENCY (Typ.)	76%	82%	83%	84%
AC CURRENT (max.)	1.2A / 115VAC	0.8A / 230VAC		
INRUSH CURRENT (Typ.)	COLD START 18A / 115VAC; 36A / 230VAC			

## PROTECTION

OVERLOAD	105 ~ 160% rated output power Protection type: Constant current limiting recovers automatically after fault condition is removed			
OVERVOLTAGE	5.75 ~ 6.75V	13.8 ~ 16.2V	17.25 ~ 20.25V	27.6 ~ 32.4V

Protection type: Shut down overvoltage, re-power on to recover

## ENVIRONMENT

WORKING TEMP.	-20 ~ +60°C (Refer to output load derating curve)
WORKING HUMIDITY	20 ~ 90% RH non-condensing
STORAGE TEMP., HUMIDITY	-40 ~ +85°C, 10 ~ 95% RH
TEMP. COEFFICIENT	±0.03% / °C (0 ~ 50°C)
VIBRATION	10 ~ 500Hz, 2G 10min. / 1cycle, 60 min. each long X,Y, Z axes
MOUNTING	Compliance to IEC60068-2-6

## SAFETY & EMC

SAFETY STANDARDS	UL60950-1 EN60950-1 compliant Design refer to EN50178
WITHSTAND VOLTAGE	I/P-O/P: 3KVAC
ISOLATION RESISTANCE	I/P-O/P: 100M Ohms/500VDC (25°C; 70% RH)
EMI CONDUCTION & RADIATION	Compliance to EN55011 EN55022 (CISPR22) Class B
HARMONIC CURRENT	Compliance to EN61000-3-2,-3
EMS IMMUNITY	Compliance to EN61000-4-2,3,4,5,6,8,11; ENV50204; EN55024; EN61000-6-2; EN61204-3; heavy industry level; criteria A

The power supply is considered a component which will installed into a final equipment. The final equipment must be re-confirmed that it still meets EMC directives.

## OTHERS

MTBF	216.2K hrs min. MIL-HDBK-217K (25°C)
DIMENSION	78x93x56mm (WxHxD)
PACKING	0.3Kg; 48pcs / 15.4Kg / 1.02CUFT

All parameters NOT specially mentioned are measured at 230V AC input, rated load and 25°C of ambient temperature

## Mechanical Specification

Terminal Pin. No Assignment

Pin No.	Assignment	Pin No.	Assignment
1	AC/L	5,6	-V
2	AC/N	7	LED
3,4	+V	8	+V ADJ.

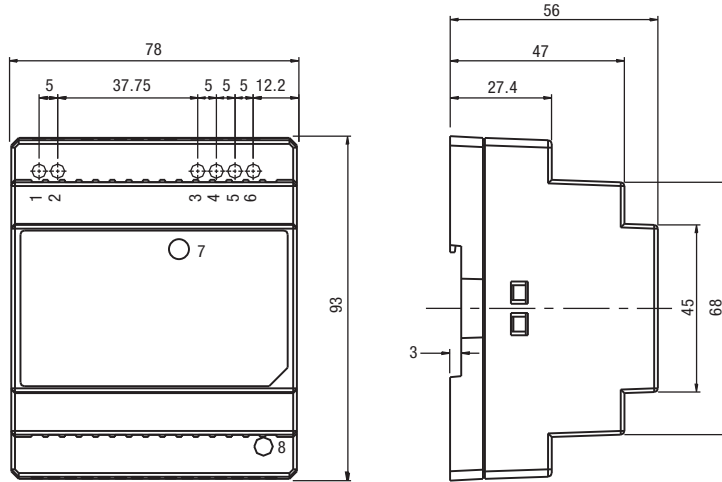

## Block Diagram

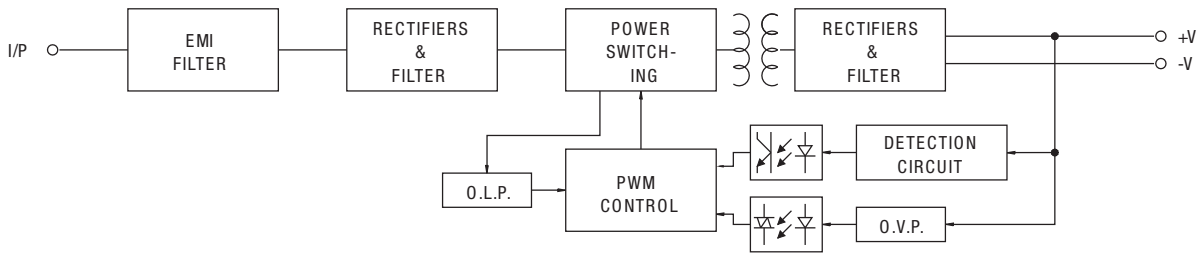

## Derating Curve

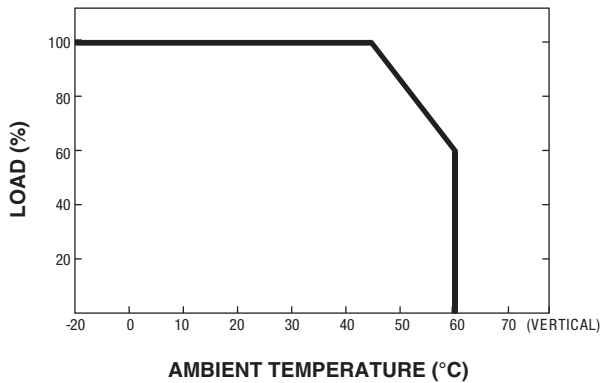

## Output Derating VS Input Voltage

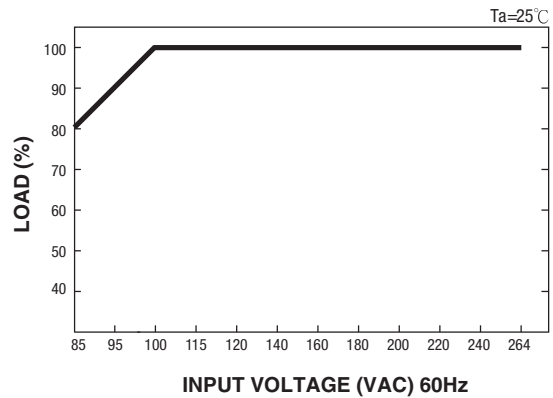

Note: All dimensions are in millimeters, to convert to inches multiply by 0.03937.





# PS-100 Series Specifications



## Features:

- Universal AC input / full range
- Protections: Short Circuit / Overload / Over Voltage / Overtemperature
- Cooling by free air convection
- DIN rail mountable
- Isolation class II
- LED indicator for power on
- No load power consumption <1W
- 100% full load burn-in test
- 3 year warranty

## OUTPUT

Cat. No.	PS-10012	PS-10015	PS-10024
----------	----------	----------	----------

DC VOLTAGE	12V	15V	24V
RATED CURRENT	7.5A	6.5A	4.2A
CURRENT RANGE	0 ~ 7.5A	0 ~ 6.5A	0 ~ 4.2A
RATED POWER	90W	97.5W	100.8W
RIPPLE & NOISE (max)	120mVp-p	120mVp-p	150mVp-p
Ripple & noise are measured at 20MHz of bandwidth by using a 12 twisted pair-wire terminated with a 0.1µF & 47µF parallel capacitor.			
VOLTAGE ADJ. RANGE	12 ~ 15V	15 ~ 18V	24 ~ 29V
VOLTAGE TOLERANCE	±2.0%	±1.0%	±1.0%
Tolerance: includes set up tolerance, line regulation and load regulation.			
LINE REGULATION	±1.0%	±1.0%	±1.0%
LOAD REGULATION	±1.0%	±1.0%	±1.0%
SETUP, RISE TIME	2700ms, 80ms / 230VAC	2700ms, 80ms / 115VAC at full load	
HOLD UP TIME (Typ.)	50ms / 230VAC	18ms / 115VAC at full load	

## INPUT

VOLTAGE RANGE	88 ~ 264VAC	124 ~ 370VDC [ Connect AC/L(+), AC/N(-) ]	
FREQUENCY RANGE	47 ~ 63Hz		
EFFICIENCY (Typ.)	87%	87%	89%
AC CURRENT (max.)	3A / 115VAC	1.6A / 230VAC	
INRUSH CURRENT (Typ.)	COLD START 30A / 115VAC;	45A / 230VAC	

## PROTECTION

OVERLOAD	105 ~ 135% rated output power Protection type: Constant current limiting recovers automatically after fault condition is removed Under short circuit or overload ≥ 150% conditions, output voltage may shut down for 5 sec. and then go into constant current protection mode		
OVERVOLTAGE	16 ~ 20V	19 ~ 23V	30 ~ 35V
OVERTEMPERATURE	90°C ± 15°C (RTH2) detect on heat sink of power transistor Protection type: Shut down overvoltage, re-power on to recover		

## ENVIRONMENT

WORKING TEMP.	-20 ~ +60°C (Refer to output load derating curve)		
WORKING HUMIDITY	20 ~ 90% RH non-condensing		
STORAGE TEMP., HUMIDITY	-40 ~ +85°C, 10 ~ 95% RH		
TEMP. COEFFICIENT	±0.03% / °C (0 ~ 50°C)		
VIBRATION	10 ~ 500Hz, 2G 10min. / 1cycle, 60 min. each long X,Y, Z axes		
MOUNTING	Compliance to IEC60068-2-6		

## SAFETY & EMC

SAFETY STANDARDS	UL60950-1 EN60950-1 compliant Design refer to EN50178		
WITHSTAND VOLTAGE	I/P-O/P: 3KVAC		
ISOLATION RESISTANCE	I/P-O/P: 100M Ohms/500VDC (25°C; 70% RH)		
EMI CONDUCTION & RADIATION	Compliance to EN61204-3; EN55022 (CISPR22) Class B		
HARMONIC CURRENT	Compliance to EN61000-3-2,-3 Harmonic current test @ 90% load		
EMS IMMUNITY	Compliance to EN61000-4-2,3,4,5,6,8,11; ENV50204; EN55024; EN61000-6-2; EN61204-3; heavy industry level; criteria A The power supply is considered a component which will installed into a final equipment. The final equipment must be re-confirmed that it still meets EMC directives.		

## OTHERS

MTBF	486K hrs min. MIL-HDBK-217K (25°C)		
DIMENSION	100x93x56mm (WxHxD)		
PACKING	0.35Kg; 36pcs / 13.6Kg / 0.89CUFT		
NOTE	All parameters NOT specially mentioned are measured at 230V AC input, rated load and 25°C of ambient temperature.		

## Mechanical Specification

Terminal Pin. No Assignment

Pin No.	Assignment	Pin No.	Assignment
1	AC/L	5,6	-V
2	AC/N	7	LED
3,4	+V	8	+V ADJ.

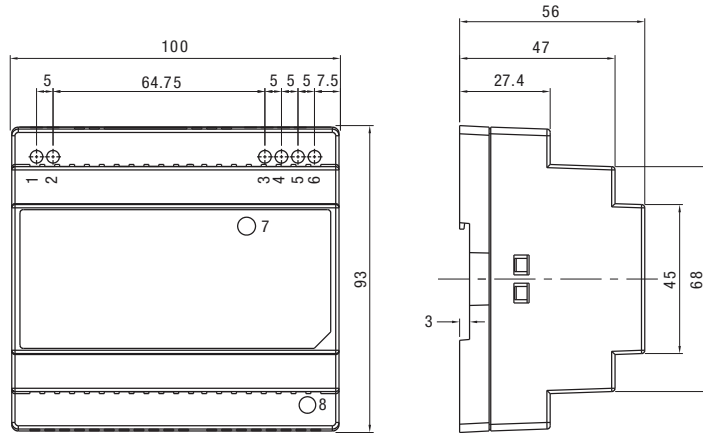

## Block Diagram

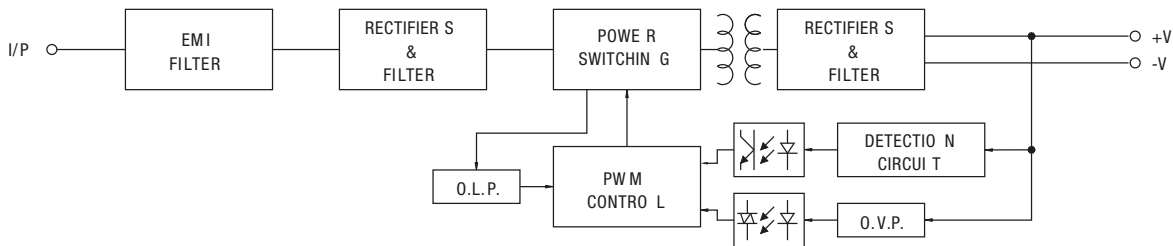

## Derating Curve

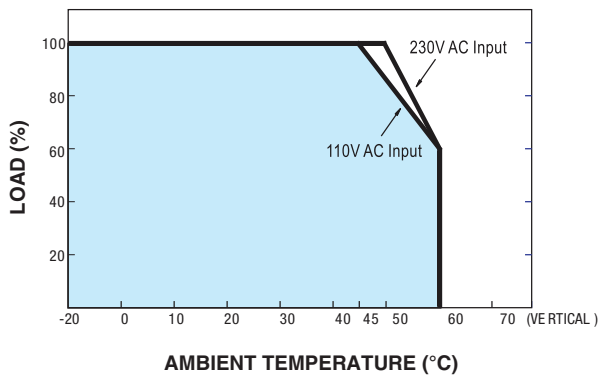

## Output Derating VS Input Voltage

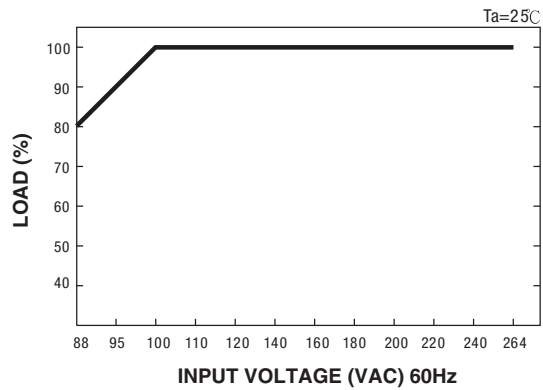

Note: All dimensions are in millimeters, to convert to inches multiply by 0.03937.



## Industrial Metal Case Single Phase and Three Phase Power Supply

The Altech Industrial metal case power supplies have been optimized for use in practically any DC power applications, with a wide range of AC/DC inputs and an extended temperature range of -20° C up to +70° C. These metal case power supplies feature a small housing design and high power reserve. Excellent electrical specifications and high immunity against fluctuations in input voltage make these metal case modules the best choice to industrial automation. Altech's metal case power supplies are available in six single-phase and four three-phase models with 12VDC (75W and 120W), 24 VDC and 48VDC output voltages, and up to 40A output currents. This voltage range enables the Industrial metal case supplies to be used in virtually any single-phase or three-phase application. The Industrial metal case power supply series offers users easy wiring with screw terminal blocks and snap-on DIN-rail mounting. Designed for use in numerous applications around the world, this power supplies are UL and CSA approved, CE marked and ROHS compliant. They feature a rugged metal housing, vibration- and shock-proof construction and provide a cost-effective power delivery solution for basic functionality requirements.

### Single Phase Power Supply:

- Input voltage range: 85-264V AC / 120-370V DC
- AC inrush current: Cold start: 20A at 115V AC, 40A at 230V AC
- Overload voltage protection: 105%-160% constant current limiting auto-recovery
- Over-voltage protection: 115%-135% rated output voltage
- Setup, rise, hold up time: 500ms; 70ms; 30ms at full load and 230V AC
- Working temperature: -20 to +50°C (-4° to +122°F) at 100%  
+60°C (+140°F) at 80% load

### Three Phase Power Supply:

- Three phase input
- Input voltage range: 340-550V AC / 480-760V DC
- AC inrush current: Cold start: 50A
- Overload voltage protection: 105%-150% constant current limiting auto-recovery
- Over-voltage protection: 115%-135% rated output voltage
- Setup, rise, hold up time: 1200ms, 40ms, 20ms @ 400V AC  
800ms, 40ms, 40ms @ 500V AC full load
- Working temperature: -20 to +70°C (-4 to +158°F) at 100%
- EMC standards: EN61000-6-2 (EN50082-2)  
Heavy Industrial Level; criteria A
- Military standard: MIL-HDBK-217K

# PS Series - Metal Case



## Features:

- Universal AC input / Full range
- Single phase or Three phase
- Built in active PFC function
- Protections: Short circuit / Overload / Overvoltage / Over temperature
- Cooling by free air convection
- DIN rail mountable
- UL 508 (industrial control equipment) approved
- LED indicator for power on
- 100% full load burn-in test
- 3 year warranty

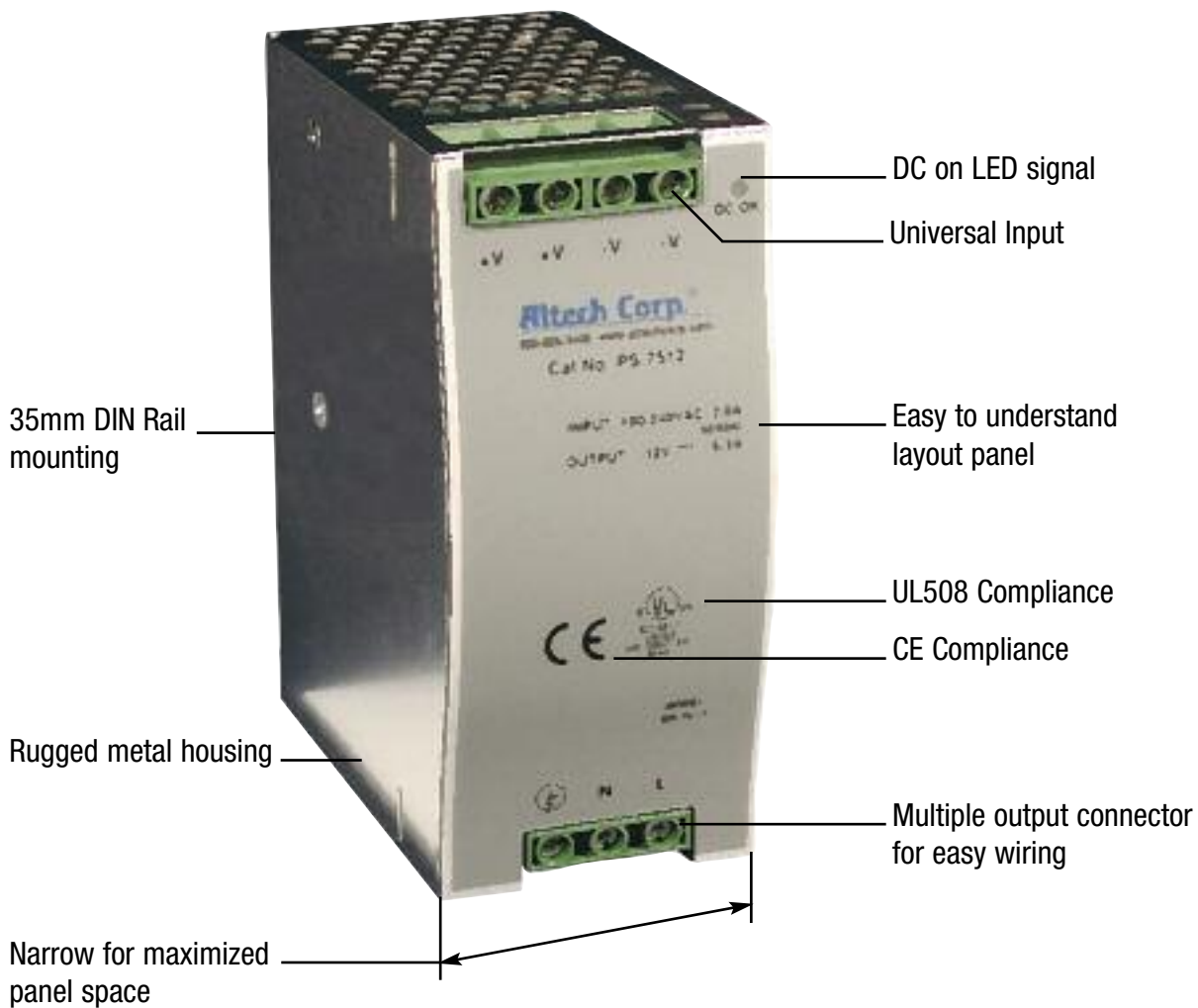

# 75-240W Single Phase POWER SUPPLIES



## 75W Single Output DIN Rail Power Supply

Cat. No.	Output		Tol. %	Ripple & Noise	Efficiency	NOTES
	V DC	A				
PS-7512	12V DC	6.3A	±2%	100 mVp-p	76%	
PS-7524	24V DC	3.2A	±1%	150 mVp-p	80%	
PS-7548	48V DC	1.6A	±1%	240 mVp-p	81%	



110/220V SWITCH SELECT

## 120W Single Output DIN Rail Power Supply

Cat. No.	Output		Tol. %	Ripple & Noise	Efficiency	NOTES
	V DC	A				
PS-12012	12V DC	10A	±2%	80 mVp-p	80%	
PS-12024	24V DC	5A	±1%	80 mVp-p	84%	
PS-12048	48V DC	2.5A	±1%	100 mVp-p	85%	



HIGH INPUT

## 120W High Input Single Output DIN Rail Power Supply

Cat. No.	Output		Tol. %	Ripple & Noise	Efficiency	NOTES
	V DC	A				
PSH-12024	24V DC	5A	±1%	80 mVp-p	85%	
PSH-12048	48V DC	2.5A	±1%	80 mVp-p	86%	



## 240W Single Output DIN Rail Power Supply with PFC Function

Cat. No.	Output		Tol. %	Ripple & Noise	Efficiency	NOTES
	V DC	A				
PSP-24024	24V DC	10A	±1%	80 mVp-p	84%	
PSP-24048	48V DC	5A	±1%	150 mVp-p	85%	

# SPECIFICATIONS

## PS-75 Series

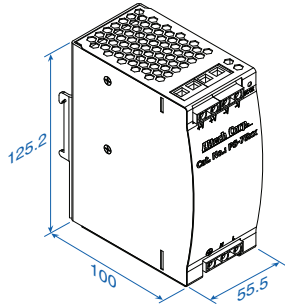

Terminal Pin. No Assign. (TB1)

Pin No.	Assignment
1	FG ⊕
2	AC/N
3	AC/L

Terminal Pin. No Assign. (TB2)

Pin No.	Assignment
1,2	DC OUTPUT +V
3,4	DC OUTPUT -V

Universal Input: 85-264V AC, 120-370V DC full range,  
1.6A @ 115V AC, 0.96A @ 230V AC

Connection: Input - 3 poles, Output - 4 poles screw terminal

Size (WxHxD): 55.5x125x100mm (2.20x4.95x3.95 inches)

Packaging: 1/box; 1.35lbs / 0.60Kg

## PS-120 Series (Switch Select)

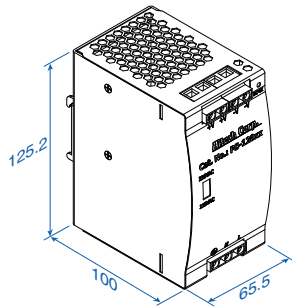

Terminal Pin. No Assign. (TB1)

Pin No.	Assignment
1	FG ⊕
2	AC/N
3	AC/L

Terminal Pin. No Assign. (TB2)

Pin No.	Assignment
1,2	DC OUTPUT +V
3,4	DC OUTPUT -V

Switch select Input: 88-132V AC / 176-264 V AC, 248-370V DC range,  
2.6A @ 115V AC, 1.6A @ 230V AC

Connection: Input - 3 poles, Output - 4 poles screw terminal

Size (WxHxD): 65.5x125x100mm (2.56x4.95x3.95 inches)

Packaging: 1/box; 1.75lbs / 0.79Kg

## PSH-120 High Input Series

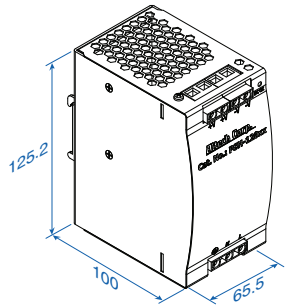

Terminal Pin. No Assign. (TB1)

Pin No.	Assignment
1	FG ⊕
2	AC/N(L2)
3	AC/L(L1)

Terminal Pin. No Assign. (TB2)

Pin No.	Assignment
1,2	DC OUTPUT +V
3,4	DC OUTPUT -V

Universal Input: 340-550V AC, 480-780V DC range,  
0.65A @ 400V AC, 0.6A @ 500V AC

Connection: Input - 3 poles, Output - 4 poles screw terminal

Size (WxHxD): 65.5x125x100mm (2.56x4.95x3.95 inches)

Packaging: 1/box; 1.65lbs / 0.75Kg

## PSP-240 Series

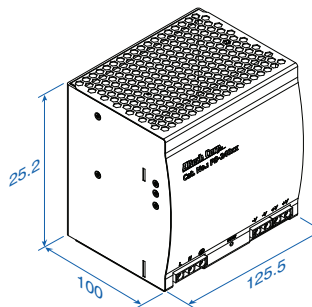

Terminal Pin. No Assign. (TB1)

Pin No.	Assignment
1	FG ⊕
2	AC/N
3	AC/L

Terminal Pin. No Assign. (TB2)

Pin No.	Assignment
1,2	DC OUTPUT +V
3,4	DC OUTPUT -V

Universal Input: 85-264V AC, 120-370V DC full range,  
2.8A @ 115V AC, 1.4A @ 230V AC

Built in active Power Factor Correction function. PF>0.95

Connection: Input - 3 poles, Output - 4 poles screw terminal

Size (WxHxD): 125x125x100mm (4.95x4.95x3.95 inches)

Packaging: 1/box; 2.7lbs / 1.2Kg

*Note: All dimensions are in millimeters, to convert to inches multiply by 0.03937.*



# PS-75 Series Specifications



## Features:

- Universal AC input / full range
- Protections: Short Circuit / Over load / Overvoltage / Over temperature
- Cooling by free air convection
- DIN rail mountable
- UL508 (industrial control equipment) approved
- LED indicator for power on
- 100% full load burn-in test
- Fix switching frequency at 50KHz
- 3 year warranty

## OUTPUT

Cat. No.	PS-7512	PS-7524	PS-7548
----------	---------	---------	---------

DC VOLTAGE	12V	24V	48V
RATED CURRENT	6.3A	3.2A	1.6A
CURRENT RANGE	0 ~ 6.3A	0 ~ 3.2A	0 ~ 1.6A
RATED POWER	76W	76.8W	76.8W
RIPPLE & NOISE (max)	100mVp-p	150mVp-p	240mVp-p
VOLTAGE ADJ. RANGE	12 ~ 14V	24 ~ 28V	48 ~ 53V
VOLTAGE TOLERANCE	±2.0%	±1.0%	±1.0%
LINE REGULATION	±0.5%	±0.5%	±0.5%
LOAD REGULATION	±1.0%	±1.0%	±1.0%
SETUP, RISE TIME	1000ms, 60ms / 230VAC	1800ms, 60ms / 115VAC at full load	
HOLD UP TIME (Typ.)	60ms / 230VAC	12ms / 115VAC at full load	

Ripple & noise are measured at 20MHz of bandwidth by using a 12 twisted pair-wire terminated with a 0.1µF & 47µF parallel capacitor.

Tolerance: includes set up tolerance, line regulation and load regulation.

## INPUT

VOLTAGE RANGE	85 ~ 264VAC	120 ~ 370VDC	
FREQUENCY RANGE	47 ~ 63Hz		
EFFICIENCY (Typ.)	76%	80%	81%
AC CURRENT (max.)	1.6 A / 115VAC	0.96A / 230VAC	
INRUSH CURRENT (Typ.)	COLD START	20A / 115VAC	40A / 230VAC
LEAKAGE CURRENT	≤ 1mA / 240VAC		

## PROTECTION

OVERLOAD	105 ~ 150% rated output power		
OVERVOLTAGE	15 ~ 16.5V	29 ~ 34V	58 ~ 65V
OVERTEMPERATURE	85°C ± 5°C (TSW1) detect on heat sink of power transistor		

Protection type: Shut down overvoltage, re-power on to recover

## ENVIRONMENT

WORKING TEMP.	-10 ~ +60°C (Refer to output load derating curve)		
WORKING HUMIDITY	20 ~ 90% RH non-condensing		
STORAGE TEMP., HUMIDITY	-20 ~ +85°C, 10 ~ 95% RH		
TEMP. COEFFICIENT	±0.03% / °C (0 ~ 50°C)		
VIBRATION	10 ~ 500Hz, 2G 10min./1cycle, 60 min. each long X,Y, Z axes		
MOUNTING	Compliance to IEC60068-2-6		

## SAFETY & EMC

SAFETY STANDARDS	UL508 EN60950-1 compliant		
WITHSTAND VOLTAGE	I/P-O/P: 3KVAC I/P-FG: 1.5KVAC O/P-FG: 0.5KVAC		
ISOLATION RESISTANCE	I/P-O/P, I/P-FG, O/P-FG: 100M Ohms / 500VDC		
EMI CONDUCTION & RADIATION	Compliance to EN55011; EN55022 (CISPR22) Class B		
HARMONIC CURRENT	Compliance to EN61000-3-2,-3		
EMS IMMUNITY	Compliance to EN61000-4-2,3,4,5,6,8,11; ENV50204; EN55024; EN61000-6-2; (EN50082-2) heavy industry level; criteria A		

The power supply is considered a component which will be installed into a final equipment. The final equipment must be re-confirmed that it still meets EMC directives.

## OTHERS

MTBF	123.1K hrs min. MIL-HDBK-217K (25°C)		
DIMENSION	55.5x125.2x100mm (WxHxD)		
PACKING	0.6Kg; 20pcs / 13Kg / 1.29CUFT		

All parameters NOT specially mentioned are measured at 230V AC input, rated load and 25°C of ambient temperature.



## Mechanical Specification

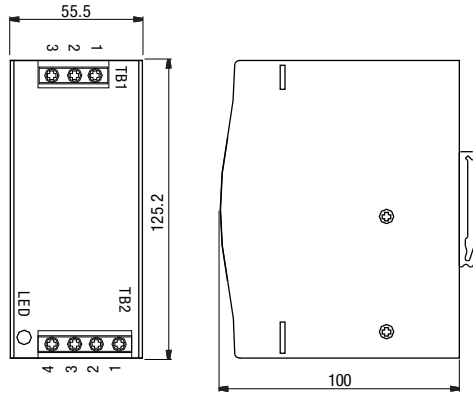

Terminal Pin. No Assignment (TB1)

Pin No.	Assignment
1	FG Ⓧ
2	AC/N
3	AC/L

Terminal Pin. No Assignment (TB2)

Pin No.	Assignment
1,2	DC OUTPUT +V
3,4	DC OUTPUT -V

## Block Diagram

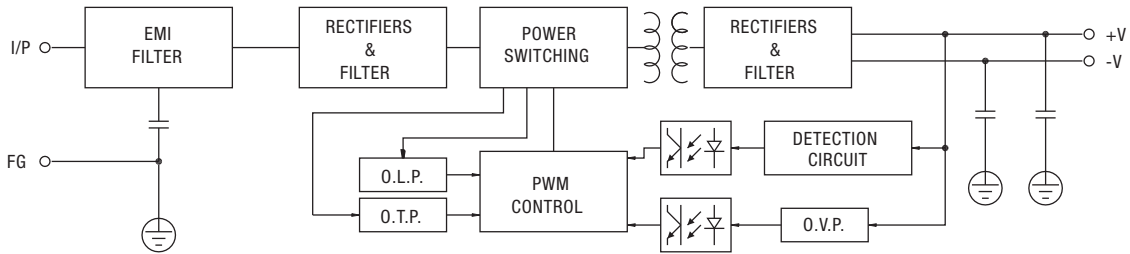

## Derating Curve

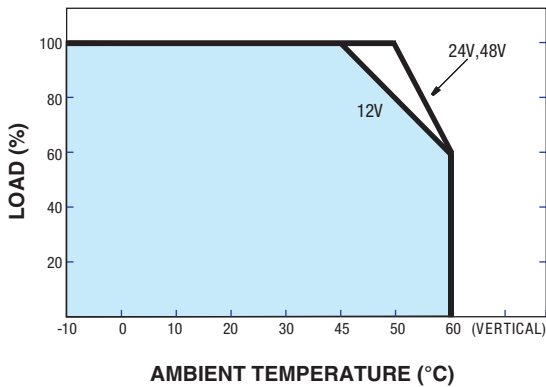

## Output Derating VS Input Voltage

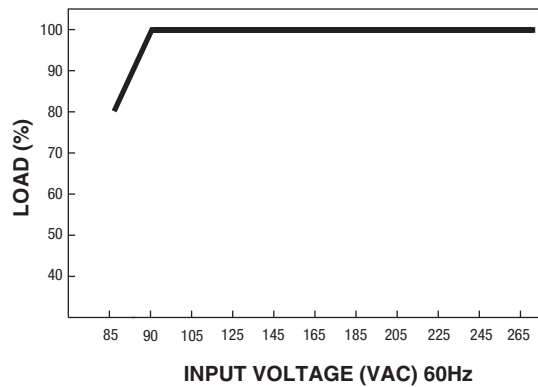

Note: All dimensions are in millimeters, to convert to inches multiply by 0.03937.



110/220V  
SWITCH SELECT

# PS-120 Series Specifications



## Features:

- Universal AC input / full range
- Protections: Short Circuit / Over load / Overvoltage/Over temperature
- Cooling by free air convection
- DIN rail mountable TS-35/ 7.5 or 1.5
- UL 508 (industrial control equipment) approved
- LED indicator for power on
- 100% full load burn-in test
- Fix switching frequency at 50KHz
- 3 year warranty

## OUTPUT

Cat. No.	PS-12012	PS-12024	PS-12048
----------	----------	----------	----------

DC VOLTAGE	12V	24V	48V
RATED CURRENT	10A	5A	2.5A
CURRENT RANGE	0 ~ 10A	0 ~ 5A	0 ~ 2.5A
RATED POWER	120W	120W	120W
RIPPLE & NOISE (max)	80mVp-p	80mVp-p	100mVp-p
VOLTAGE ADJ. RANGE	12 ~ 14V	24 ~ 28V	48 ~ 53V
VOLTAGE TOLERANCE	±2.0%	±1.0%	±1.0%
LINE REGULATION	±0.5%	±0.5%	±0.5%
LOAD REGULATION	±1.0%	±1.0%	±1.0%
SETUP, RISE TIME	500ms, 70ms / 230VAC	500ms, 70ms / 115VAC at full load	
HOLD UP TIME (Typ.)	36ms / 230VAC	32ms / 115VAC at full load	

Ripple & noise are measured at 20MHz of bandwidth by using a 12 twisted pair-wire terminated with a 0.1µF & 47µF parallel capacitor.

Tolerance: includes set up tolerance, line regulation and load regulation.

## INPUT

VOLTAGE RANGE	88 ~ 132VAC / 176 ~ 264VAC by switch		120 ~ 185VDC / 248 ~ 370VDC
FREQUENCY RANGE	47 ~ 63Hz		
EFFICIENCY (Typ.)	80%	84%	85%
AC CURRENT (max.)	2.6 A / 115VAC	1.6A / 230VAC	
INRUSH CURRENT (Typ.)	COLD START	20A / 115VAC	40A / 230VAC
LEAKAGE CURRENT	≤ 3.5mA / 240VAC		

## PROTECTION

OVERLOAD	105 ~ 150% rated output power		
	Protection type: Constant current limiting, recovers automatically after fault condition is removed		
OVERVOLTAGE	15 ~ 16.5V	29 ~ 33V	58 ~ 65V
	Protection type: Shut down overvoltage, re-power on to recover		
OVERTEMPERATURE	85°C ± 5°C (TSW1)	90°C ± 5°C (TSW1)	90°C ± 5°C (TSW1)
	Protection type: Shut down overvoltage, recovers automatically after temperature goes down		

## ENVIRONMENT

WORKING TEMP.	-10 ~ +60°C (Refer to output load derating curve)		
WORKING HUMIDITY	20 ~ 90% RH non-condensing		
STORAGE TEMP., HUMIDITY	-20 ~ +85°C, 10 ~ 95% RH		
TEMP. COEFFICIENT	±0.03% / °C (0 ~ 50°C)		
VIBRATION	10 ~ 500Hz, 2G 10min./1cycle, 60 min. each long X,Y, Z axes		
MOUNTING	Compliance to IEC60068-2-6		

## SAFETY & EMC

SAFETY STANDARDS	UL508 UL60950-1 EN60950-1 compliant		
WITHSTAND VOLTAGE	I/P-O/P: 3KVAC I/P-FG: 1.5KVAC O/P-FG: 0.5KVAC		
ISOLATION RESISTANCE	I/P-O/P, I/P-FG, O/P-FG: 100M Ohms / 500VDC		
EMI CONDUCTION & RADIATION	Compliance to EN55011; EN55022 (CISPR22) Class B		
HARMONIC CURRENT	Compliance to EN61000-3-2,-3		
EMS IMMUNITY	Compliance to EN61000-4-2,3,4,5,6,8,11; ENV50204; EN55024; EN61000-6-2; (EN50082-2); heavy industry level; criteria A		

The power supply is considered a component which will installed into a final equipment. The final equipment must be re-confirmed that it still meets EMC directives.

## OTHERS

MTBF	136.8K hrs min. MIL-HDBK-217K (25°C)		
DIMENSION	65.5x125.2x100mm (WxHxD)		
PACKING	0.79Kg; 20pcs / 16.5Kg / 1.29CUFT		

All parameters NOT specially mentioned are measured at 230V AC input, rated load and 25°C of ambient temperature.

## Mechanical Specification

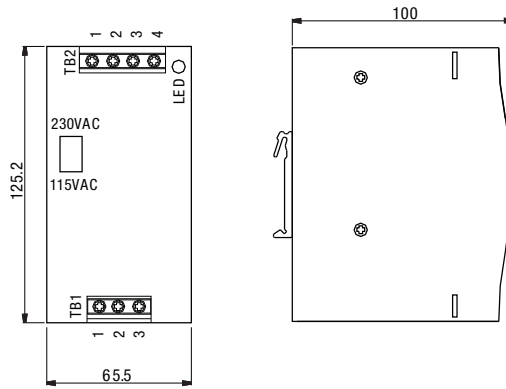

Terminal Pin. No Assignment (TB1)

Pin No.	Assignment
1	FG ⊕
2	AC/N
3	AC/L

Terminal Pin. No Assignment (TB2)

Pin No.	Assignment
1,2	DC OUTPUT +V
3,4	DC OUTPUT -V

## Block Diagram

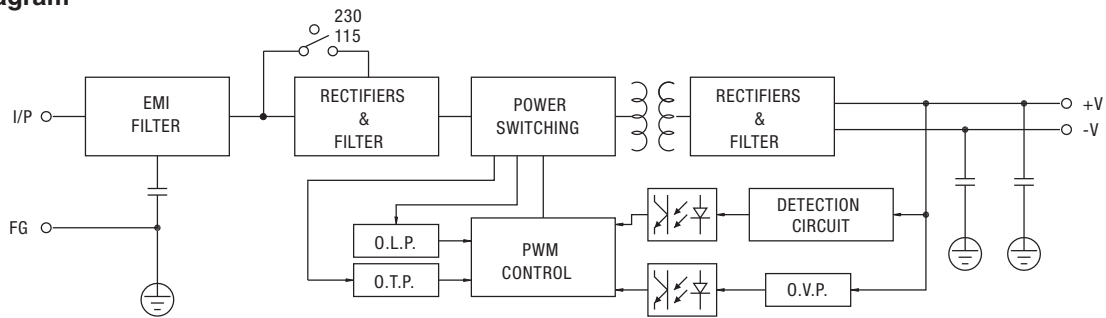

## Derating Curve

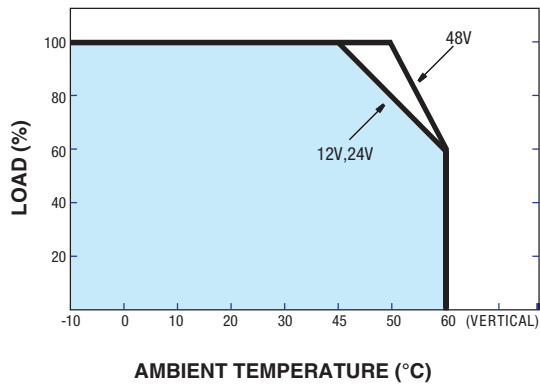

## Static Characteristics (24V)

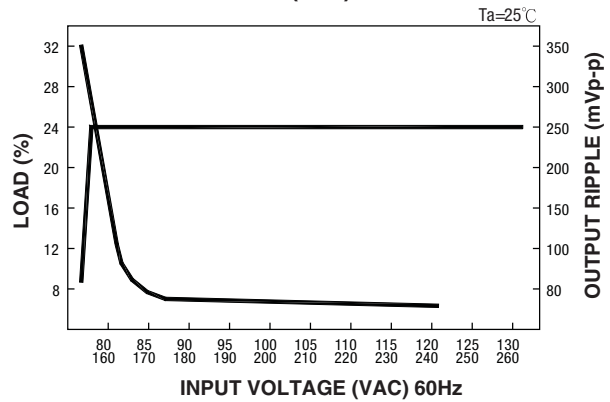

Note: All dimensions are in millimeters, to convert to inches multiply by 0.03937.



# PSH-120 High Input Series

## Specifications



### Features:

- Universal AC input / full range
- Protections: Short Circuit / Overload / Over Voltage / Overtemperature
- Cooling by free air convection
- Built-in constant current limiting circuit
- DIN rail mountable
- EN61000-6-2(EN50082-2) industrial immunity level
- 100% full load burn-in test
- Fixed switching frequency at 70KHz
- 3 year warranty

### OUTPUT

Cat. No.	PSH-12024	PSH-12048
DC VOLTAGE	24V	48V
RATED CURRENT	5A	2.5A
CURRENT RANGE	0 ~ 5A	0 ~ 2.5A
RATED POWER	120W	120W
RIPPLE & NOISE (max)	80mVp-p	80mVp-p
Ripple & noise are measured at 20MHz of bandwidth by using a 12 twisted pair-wire terminated with a 0.1µF & 47µF parallel capacitor.		
VOLTAGE ADJ. RANGE	24 ~ 28V	48 ~ 55V
VOLTAGE TOLERANCE	±1.0%	±1.0%
Tolerance: includes set up tolerance, line regulation and load regulation.		
LINE REGULATION	±0.5%	±0.5%
LOAD REGULATION	±0.5%	±0.5%
SETUP, RISE, HOLD UP TIME	1700ms, 120ms, 16ms / 400VAC	1000ms, 120ms, 30ms / 500VAC at full load

### INPUT

VOLTAGE RANGE	340 ~ 550VAC	480 ~ 780VDC
FREQUENCY RANGE	47 ~ 63Hz	
EFFICIENCY (Typ.)	85%	86%
AC CURRENT (max.)	0.65A / 400VAC	0.6A / 500VAC
INRUSH CURRENT (max.)	COLD START 50A	
LEAKAGE CURRENT	≤ 3.5 mA / 530VAC	

### PROTECTION

OVERLOAD	105 ~ 160% rated output power
Protection type: Constant current limiting, recovers automatically after fault condition is removed	
OVERVOLTAGE	30 ~ 36V
Protection type: Shut down overvoltage, re-power on to recover	
OVERTEMPERATURE	85°C ± 5°C (TSW: detect on heat sink of power switch)
Protection type: Shut down overvoltage, recovers automatically after temperature goes down	

### ENVIRONMENT

WORKING TEMP.	-20 ~ +60°C (Refer to output load derating curve)
WORKING HUMIDITY	20 ~ 90% RH non-condensing
STORAGE TEMP., HUMIDITY	-40 ~ +85°C, 10 ~ 95% RH
TEMP. COEFFICIENT	±0.03% / °C (0 ~ 50°C)
VIBRATION	10 ~ 500Hz, 2G 10min./1cycle, 60 min. each long X,Y, Z axes
MOUNTING	Compliance to IEC60068-2-6

### SAFETY & EMC

SAFETY STANDARDS	UL60950-1 approved IEC60950-1 CB compliant
WITHSTAND VOLTAGE	I/P-O/P: 3KVAC I/P-FG: 1.5KVAC O/P-FG: 0.5KVAC
ISOLATION RESISTANCE	I/P-O/P, I/P-FG, O/P-FG: 100M Ohms / 500VDC (25°C; 70% RH)
EMI CONDUCTION & RADIATION	Compliance to EN55011 (CISPR11); EN55022 (CISPR22); EN61204-3 Class B
EMS IMMUNITY	Compliance to EN61000-4-2,3,4,5,6,8,11; ENV50204; EN61204-3; EN61000-6-2; (EN50082-2), heavy industry level; criteria A
The power supply is considered a component which will be installed into a final equipment. The final equipment must be re-confirmed that it still meets EMC directives.	

### OTHERS

MTBF	178.7K hrs min. MIL-HDBK-217K (25°C)
DIMENSION	65.5x125.2x100mm (WxHxD)
PACKING	0.75Kg; 20pcs / 16Kg / 1.29CUFT
All parameters NOT specially mentioned are measured at 230V AC input, rated load and 25°C of ambient temperature.	

## Mechanical Specification

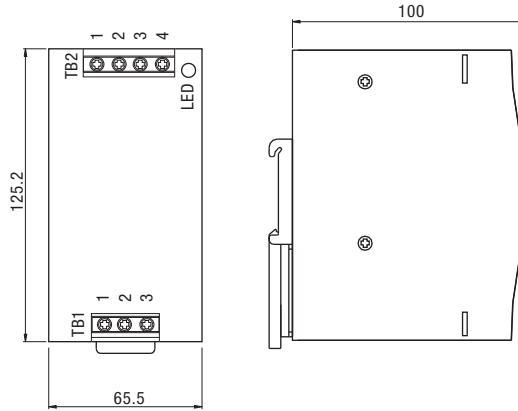

Terminal Pin No. Assignment (TB1)

Pin No.	Assignment
1	FG ⊕
2	AC/L2
3	AC/L1

Terminal Pin No. Assignment (TB2)

Pin No.	Assignment
1,2	DC OUTPUT +V
3,4	DC OUTPUT -V

## Block Diagram

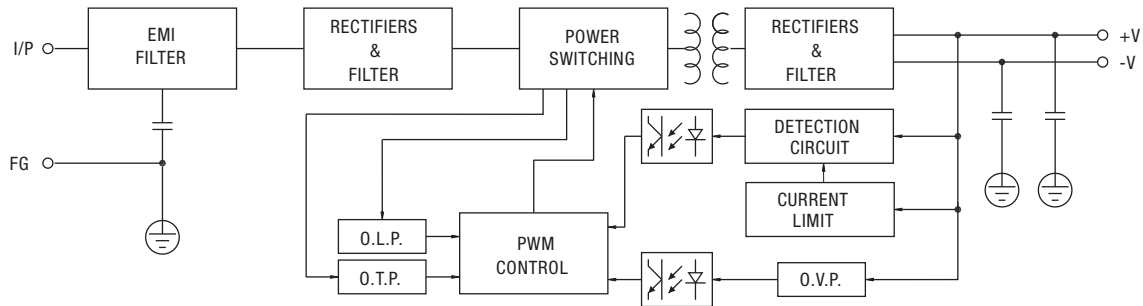

## Derating Curve

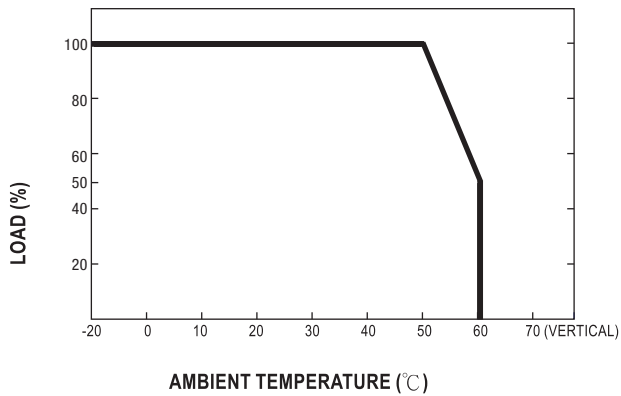

Note: All dimensions are in millimeters, to convert to inches multiply by 0.03937.



# PSP-240 Series Specifications



## Features:

- Universal AC input / full range
- Built in active PFC function
- Protections: Short Circuit / Overload / Overvoltage / Over temperature
- Cooling by free air convection
- DIN rail mountable
- UL 508(industrial control equipment)approved
- LED indicator for power on
- 100% full load burn-in test
- Fixed switching frequency at 100KHz
- 3 year warranty

## OUTPUT

Cat. No.	PSP-24024	PSP-24048
----------	-----------	-----------

DC VOLTAGE	24V	48V
RATED CURRENT	10A	5A
CURRENT RANGE	0 ~ 10A	0 ~ 5A
RATED POWER	240W	240W
RIPPLE & NOISE (max)	80mVp-p	150mVp-p
VOLTAGE ADJ. RANGE	24 ~ 28V	48 ~ 53V
VOLTAGE TOLERANCE	±1.0%	±1.0%
LINE REGULATION	±0.5%	±0.5%
LOAD REGULATION	±1.0%	±1.0%
SETUP, RISE TIME	800ms, 40ms / 230VAC	800ms, 40ms / 115VAC at full load
HOLD UP TIME (Typ.)	24ms / 230VAC	24ms / 115VAC at full load

## INPUT

VOLTAGE RANGE	85 ~ 264VAC	120 ~ 370VDC
FREQUENCY RANGE	47 ~ 63Hz	
POWER FACTOR (Typ.)	0.96 / 230VAC	0.99 / 115VAC at full load
EFFICIENCY (Typ.)	84%	85%
AC CURRENT (max.)	2.8A / 115VAC; 1.4A / 230VAC	
INRUSH CURRENT (Typ.)	COLD START 27A / 115VAC	45A / 230VAC
LEAKAGE CURRENT	≤ 3.5mA / 240VAC	

## PROTECTION

OVERLOAD	105 ~ 150% rated output power
OVERVOLTAGE	30 ~ 36V
OVERTEMPERATURE	100°C ± 5°C (TSW: detect on heat sink of power transistor)

## ENVIRONMENT

WORKING TEMP.	-10 ~ +70°C (Refer to output load derating curve)
WORKING HUMIDITY	20 ~ 90% RH non-condensing
STORAGE TEMP., HUMIDITY	-20 ~ +85°C, 10 ~ 95% RH
TEMP. COEFFICIENT	±0.03% / °C (0 ~ 50°C)
VIBRATION	10 ~ 500Hz, 2G 10min./1cycle, 60 min. each long X,Y, Z axes
MOUNTING	Compliance to IEC60068-2-6

## SAFETY & EMC

SAFETY STANDARDS	UL508 UL60950-1 EN60950-1 compliant
WITHSTAND VOLTAGE	I/P-O/P: 3KVAC I/P-FG: 1.5KVAC O/P-FG: 0.5KVAC
ISOLATION RESISTANCE	I/P-O/P, I/P-FG, O/P-FG: 100M Ohms / 500VDC
EMI CONDUCTION & RADIATION	Compliance to EN55011; EN55022 (CISPR22) Class B
HARMONIC CURRENT	Compliance to EN61000-3-2,-3
EMS IMMUNITY	Compliance to EN61000-4-2,3,4,5,6,8,11; ENV50204; EN55024; EN61000-6-2; (EN50082-2); heavy industry level; criteria A

## OTHERS

MTBF	289.9K hrs min. MIL-HDBK-217K (25°C)
DIMENSION	125.5x125.2x100mm (WxHxD)
PACKING	1.2Kg; 12pcs / 15.5Kg / 1.29CUFT

All parameters NOT specially mentioned are measured at 230V AC input, rated load and 25°C of ambient temperature.

# Mechanical Specification

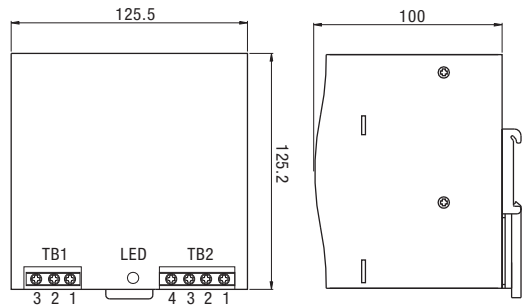

Terminal Pin Number Assignment (TB1)

Pin No.	Assignment
1	FG ⊕
2	AC/N
3	AC/L

Terminal Pin Number Assignment (TB2)

Pin No.	Assignment
1,2	DC OUTPUT +V
3,4	DC OUTPUT -V

# Block Diagram

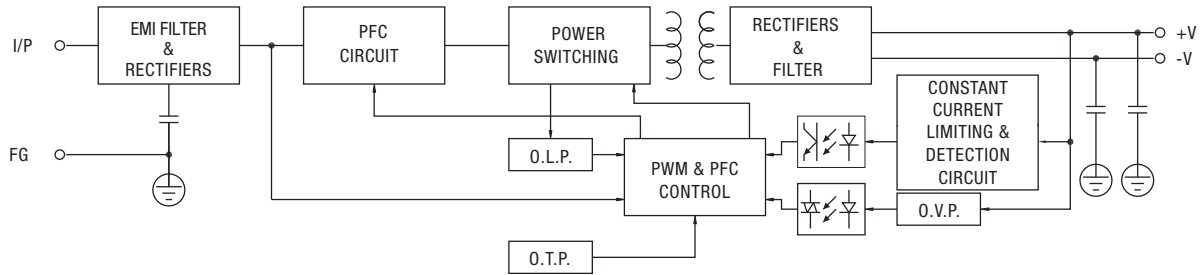

# Derating Curve

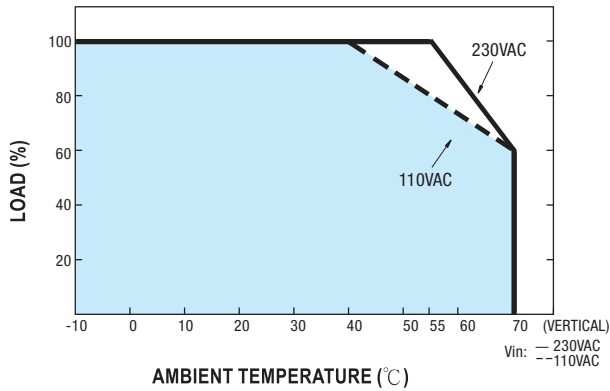

# Output Derating VS Input Voltage

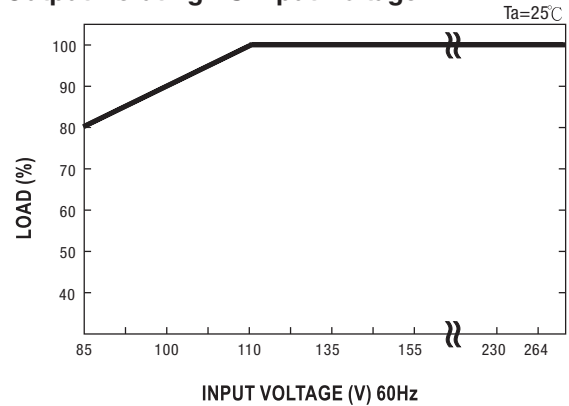

Note: All dimensions are in millimeters, to convert to inches multiply by 0.03937.



# 480W Single Phase POWER SUPPLIES



**220V ONLY**

## 480W 220V AC Single Output DIN Rail Power Supply with PFC Function

Cat. No.	Output		Tol. %	Ripple & Noise	Efficiency	NOTES
	V DC	A				
PSP-48024	24V DC	20A	±1%	120 mVp-p	89%	
PSP-48048	48V DC	10A	±1%	120 mVp-p	89%	



**110/220V  
SWITCH SELECT**

## 480W Switch Select 110/220V AC Single Output DIN Rail Power Supply with PFC Function

Cat. No.	Output		Tol. %	Ripple & Noise	Efficiency	NOTES
	V DC	A				
PSP-480S24	24V DC	20A	±1%	120 mVp-p	89%	
PSP-480S48	48V DC	10A	±1%	120 mVp-p	89%	

# SPECIFICATIONS

## PSP-480 Series (220V AC input only)

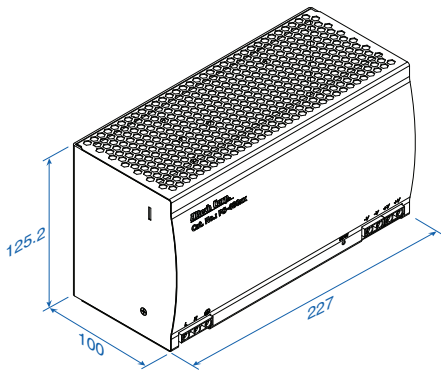

TB1 Terminal Pin. No Assignment

Pin No.	Assignment
1	AC/L
2	AC/N
3	FG ⊕

TB2 Terminal Pin. No Assignment

Pin No.	Assignment
1,2	DC OUTPUT +V
3,4	DC OUTPUT -V

Wide range Input: 180-264V AC only, 250-370V DC, 4A @ 230V AC  
 Built in passive Power Factor Correction function compliance to EN61000-3-2, PF>0.7

Connection: Input - 3 poles, Output - 4 poles screw terminal

Size (WxHxD): 227x125x100mm (8.95x4.95x3.95 inches)

Packaging: 1/box; 5.3lbs / 2.4Kg

## PSP-480 with Switch Series (110V AC and 220V input AC)

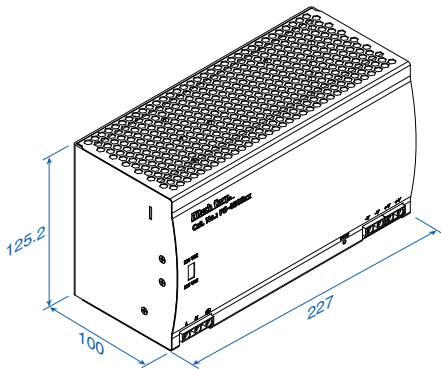

TB1 Terminal Pin. No Assignment

Pin No.	Assignment
1	AC/L
2	AC/N
3	FG ⊕

TB2 Terminal Pin. No Assignment

Pin No.	Assignment
1,2	DC OUTPUT +V
3,4	DC OUTPUT -V

Switch select Input: 90-132V AC / 180-264 V AC, 254-370V DC range  
 8A @ 115V AC, 3.2A @ 230V AC

Built in passive Power Factor Correction function compliance to EN61000-3-2, PF>0.7/230V AC only

Connection: Input - 3 poles, Output - 4 poles screw terminal

Size (WxHxD): 227x125x100mm (8.95x4.95x3.95 inches)

Packaging: 1/box; 5.8lbs / 2.6Kg

*Note: All dimensions are in millimeters, to convert to inches multiply by 0.03937.*



**220V ONLY**

# PSP-480 Series Specifications



## Features:

- Built-in passive PFC function compliance to EN61000-3-2
- High efficiency 89% and low dissipation
- Protections: Short Circuit / Overload / Overvoltage / Over temperature
- Cooling by free air convection
- Built-in constant current limiting circuit
- DIN rail mountable
- UL 508(industrial control equipment)approved
- EN61000-6-2(EN50082-2) industrial immunity level
- 100% full load burn-in test
- 3 year warranty

## OUTPUT

Cat. No.	PSP-48024	PSP-48048
DC VOLTAGE	24V	48V
RATED CURRENT	20A	10A
CURRENT RANGE	0 ~ 20A	0 ~ 10A
RATED POWER	480W	480W
RIPPLE & NOISE (max)	120mVp-p	120mVp-p
Ripple & noise are measured at 20MHz of bandwidth by using a 12 twisted pair-wire terminated with a 0.1µF & 47µF parallel capacitor.		
VOLTAGE ADJ. RANGE	24 ~ 28V	48 ~ 53V
VOLTAGE TOLERANCE	±1.0%	±1.0%
Tolerance: includes set up tolerance, line regulation and load regulation.		
LINE REGULATION	±0.5%	±0.5%
LOAD REGULATION	±1.0%	±1.0%
SETUP, RISE TIME	1200ms, 40ms / 230VAC at full load	
HOLD UP TIME (Typ.)	16ms / 230VAC	

## INPUT

VOLTAGE RANGE	180 ~ 264 VAC by switch	250 ~ 370VDC
FREQUENCY RANGE	47 ~ 63Hz	
POWER FACTOR (Typ.)	≥0.7	
EFFICIENCY (Typ.)	89%	
AC CURRENT (Typ.)	4A / 230VAC	
INRUSH CURRENT (Typ.)	COLD START 27A / 115VAC	45A / 230VAC
LEAKAGE CURRENT	≤ 3.5mA / 240VAC	

## PROTECTION

OVERLOAD	105 ~ 150% rated output power	
Protection type: Constant current limiting, recovers automatically after fault condition is removed		
OVERVOLTAGE	30 ~ 36V	54 ~ 60V
Protection type: Shut down overvoltage, re-power on to recover		
OVERTEMPERATURE	100°C ± 5°C (TSW: detect on heat sink of power switch)	
Protection type: Shut down overvoltage, recovers automatically after temperature goes down		

## ENVIRONMENT

WORKING TEMP.	-20 ~ +70°C (Refer to output load derating curve)	
WORKING HUMIDITY	20 ~ 95% RH non-condensing	
STORAGE TEMP., HUMIDITY	-20 ~ +85°C, 10 ~ 95% RH	
TEMP. COEFFICIENT	±0.03% / °C (0 ~ 50°C)	
VIBRATION	10 ~ 500Hz, 2G 10min./1cycle, 60 min. each long X,Y, Z axes	
MOUNTING	Compliance to IEC60068-2-6	

## SAFETY & EMC

SAFETY STANDARDS	UL508 UL60950-1 EN60950-1 compliant	
WITHSTAND VOLTAGE	I/P-O/P: 3KVAC I/P-FG: 1.5KVAC O/P-FG: 0.5KVAC	
ISOLATION RESISTANCE	I/P-O/P, I/P-FG, O/P-FG: ≥100M Ohms / 500VDC (25°C; 70% RH)	
EMI CONDUCTION & RADIATION	Compliance to EN55022 (CISPR22); Class B	
HARMONIC CURRENT	Compliance to EN61000-3-2,-3	
EMS IMMUNITY	Compliance to EN61000-4-2,3,4,5,6,8,11; ENV50204; EN61000-6-2 (EN50082-2); heavy industry level; criteria A	
The power supply is considered a component which will installed into a final equipment. The final equipment must be re-confirmed that it still meets EMC directives.		

## OTHERS

MTBF	180.9K hrs min. MIL-HDBK-217K (25°C)	
DIMENSION	227x125.2x100mm (WxHxD)	
PACKING	2.4Kg; 6pcs / 15Kg / 1.75CUFT	
All parameters NOT specially mentioned are measured at 230V AC input, rated load and 25°C of ambient temperature.		

## Mechanical Specification

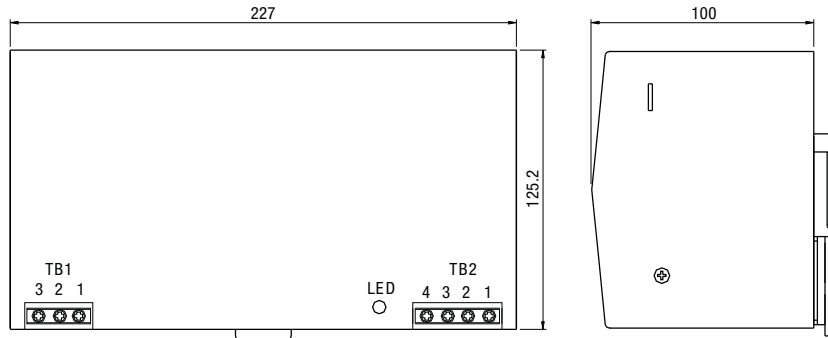

TB1 Terminal Pin. No Assignment

Pin No.	Assignment
1	AC/L
2	AC/N
3	FG $\oplus$

TB2 Terminal Pin. No Assignment

Pin No.	Assignment
1,2	DC OUTPUT +V
3,4	DC OUTPUT -V

## Block Diagram

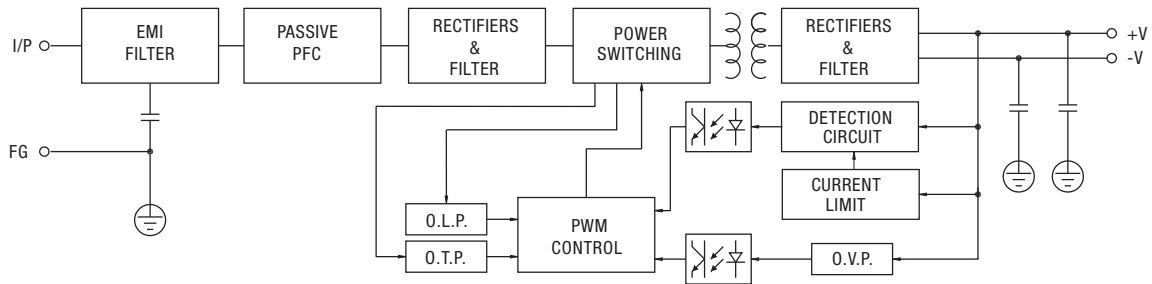

## Derating Curve

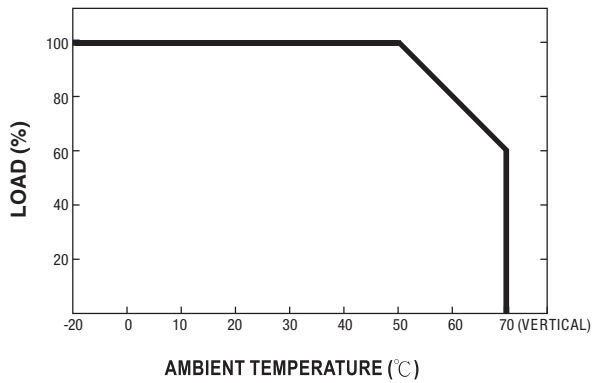

## Output Derating VS Input Voltage

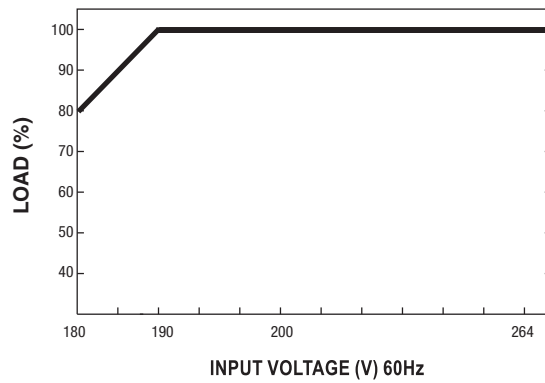

Note: All dimensions are in millimeters, to convert to inches multiply by 0.03937.



# PSP-480S Series Specifications



110/220V SWITCH SELECT

## Features:

- AC input range selectable by switch
- Built-in passive PFC function compliance to EN61000-3-2
- High efficiency 89% and low dissipation
- Protections: Short Circuit / Overload / Overvoltage / Over temperature
- Cooling by free air convection
- Built-in constant current limiting circuit
- DIN rail mountable
- UL 508(industrial control equipment)approved
- EN61000-6-2(EN50082-2) industrial immunity level
- 100% full load burn-in test
- 3 year warranty

## OUTPUT

Cat. No.	PSP-480S24	PSP-480S48
----------	------------	------------

DC VOLTAGE	24V	48V
RATED CURRENT	20A	10A
CURRENT RANGE	0 ~ 20A	0 ~ 10A
RATED POWER	480W	480W
RIPPLE & NOISE (max)	120mVp-p	120mVp-p
VOLTAGE ADJ. RANGE	24 ~ 28V	48 ~ 55V
VOLTAGE TOLERANCE	±1.0%	±1.0%
LINE REGULATION	±0.5%	±0.5%
LOAD REGULATION	±1.0%	±1.0%
SETUP, RISE TIME	1200ms, 40ms / 230VAC	1200ms, 40ms / 115VAC at full load
HOLD UP TIME (Typ.)	23ms / 230VAC	23ms / 115VAC at full load

Ripple & noise are measured at 20MHz of bandwidth by using a 12 twisted pair-wire terminated with a 0.1µF & 47µF parallel capacitor.  
Tolerance: includes set up tolerance, line regulation and load regulation.

## INPUT

VOLTAGE RANGE	90 ~ 132VAC / 180 ~ 264 VAC by switch	254 ~ 370VDC
FREQUENCY RANGE	47 ~ 63Hz	
POWER FACTOR (Typ.)	≥0.7 / 230VAC only	
EFFICIENCY (Typ.)	89%	
AC CURRENT (Typ.)	8A / 115VAC    3.2A / 230VAC	
INRUSH CURRENT (Typ.)	COLD START 27A / 115VAC    45A / 230VAC	
LEAKAGE CURRENT	≤ 3.5mA / 240VAC	

## PROTECTION

OVERLOAD	105 ~ 150% rated output power
OVERVOLTAGE	30 ~ 36V    59 ~ 66V
OVERTEMPERATURE	100°C ± 5°C (TSW: detect on heat sink of power switch)

Protection type: Constant current limiting, recovers automatically after fault condition is removed  
Protection type: Shut down overvoltage, re-power on to recover  
Protection type: Shut down overvoltage, recovers automatically after temperature goes down

## ENVIRONMENT

WORKING TEMP.	-20 ~ +70°C (Refer to output load derating curve)
WORKING HUMIDITY	20 ~ 95% RH non-condensing
STORAGE TEMP., HUMIDITY	-40 ~ +85°C, 10 ~ 95% RH
TEMP. COEFFICIENT	±0.03% / °C (0 ~ 50°C)
VIBRATION	10 ~ 500Hz, 2G 10min./1cycle, 60 min. each long X,Y, Z axes
MOUNTING	Compliance to IEC60068-2-6

## SAFETY & EMC

SAFETY STANDARDS	UL508 UL60950-1 EN60950-1 compliant
WITHSTAND VOLTAGE	I/P-O/P: 3KVAC    I/P-FG: 1.5KVAC    O/P-FG: 0.5KVAC
ISOLATION RESISTANCE	I/P-O/P, I/P-FG, O/P-FG: 100M Ohms / 500VDC / 25°C / 70% RH
EMI CONDUCTION & RADIATION	Compliance to EN55011 (CISPR11); EN55022 (CISPR22); EN61204-3 Class B
HARMONIC CURRENT	Compliance to EN61000-3-2,-3
EMS IMMUNITY	Compliance to EN61000-4-2,3,4,5,6,8,11; ENV50204; EN61204-3; EN61000-6-2 (EN50082-2); heavy industry level; criteria A

The power supply is considered a component which will installed into a final equipment. The final equipment must be re-confirmed that it still meets EMC directives.

## OTHERS

MTBF	187.9K hrs min.    MIL-HDBK-217K (25°C)
DIMENSION	227x125.2x100mm (WxD)
PACKING	2.6Kg; 6pcs / 16.6Kg / 1.75CUFT

All parameters NOT specially mentioned are measured at 230V AC input, rated load and 25°C of ambient temperature.

## Mechanical Specification

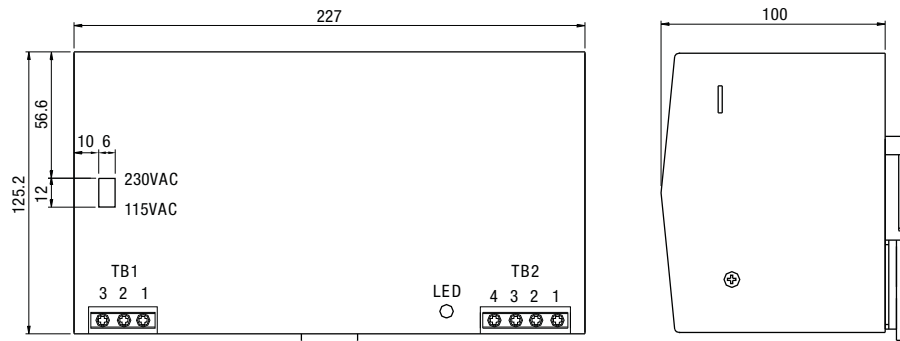

TB1 Terminal Pin. No Assignment

Pin No.	Assignment
1	AC/L
2	AC/N
3	FG $\oplus$

TB2 Terminal Pin. No Assignment

Pin No.	Assignment
1,2	DC OUTPUT +V
3,4	DC OUTPUT -V

## Block Diagram

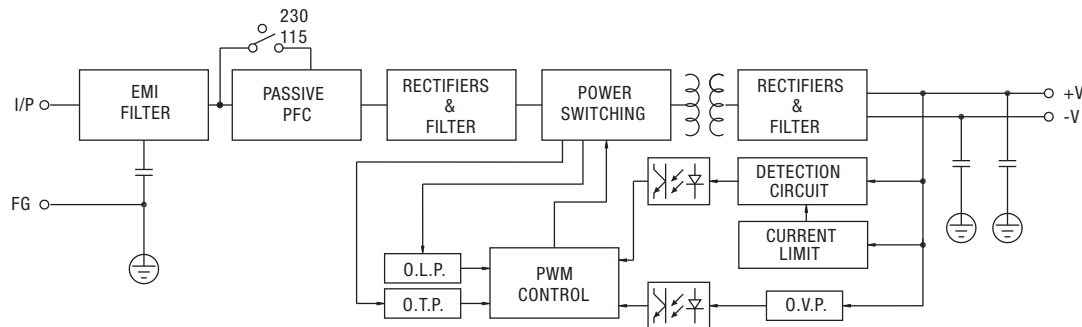

## Derating Curve

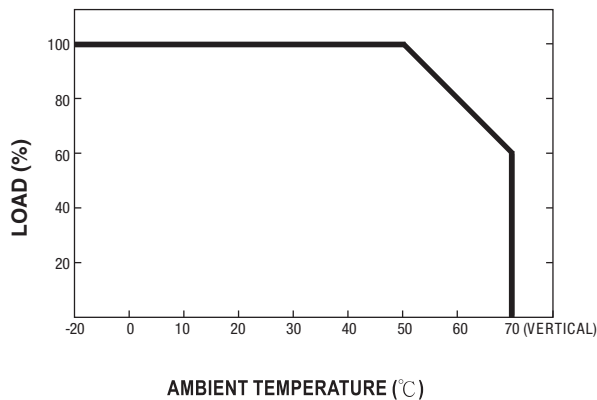

## Output Derating VS Input Voltage

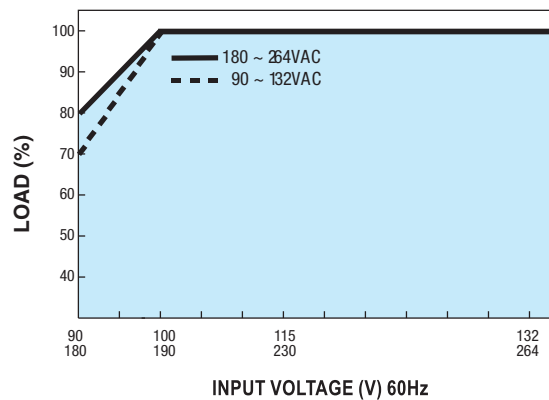

Note: All dimensions are in millimeters, to convert to inches multiply by 0.03937.

# 240-960W Three Phase POWER SUPPLIES



## 240W Three Phase Industrial DIN Rail Power Supply

Cat. No.	Output		Tol. %	Ripple & Noise	Efficiency	NOTES
	V DC	A				
PST-24024	24V DC	10A	±1%	80 mVp-p	89%	
PST-24048	48V DC	5A	±1%	80 mVp-p	89%	



## 480W Three Phase Industrial DIN Rail Power Supply

Cat. No.	Output		Tol. %	Ripple & Noise	Efficiency	NOTES
	V DC	A				
PST-48024	24V DC	20A	±1%	80 mVp-p	89%	
PST-48048	48V DC	10A	±1%	80 mVp-p	90%	



## 960W Three Phase Industrial DIN Rail Power Supply

Cat. No.	Output		Tol. %	Ripple & Noise	Efficiency	NOTES
	V DC	A				
PST-96024	24V DC	40A	±1%	80 mVp-p	91%	
PST-96048	48V DC	20A	±1%	80 mVp-p	92%	

## 960W Three Phase Industrial DIN Rail Power Supply with PFC and Parallel Function (1+1)

**PARALLEL**

Cat. No.	Output		Tol. %	Ripple & Noise	Efficiency	NOTES
	V DC	A				
PST-960P24	24V DC	40A	±1%	80 mVp-p	91%	
PST-960P48	48V DC	20A	±1%	80 mVp-p	92%	



# SPECIFICATIONS

## PST-240 Series

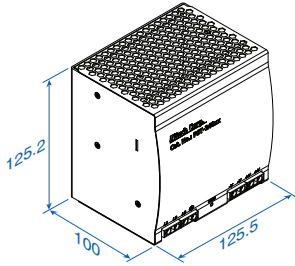

### TB1 Terminal Pin. No Assignment

Pin No.	Assignment
1	FG ⊕
2	AC/L3
3	AC/L2
4	AC/L1

### TB2 Terminal Pin. No Assignment

Pin No.	Assignment
1,2	DCOUTPUT +V
3,4	DCOUTPUT -V

Three phase input: 340-550V AC wide range, 480-780V DC  
0.95A @ 400V AC, 0.75A @ 500V AC

Connection: Input - 4 poles, Output - 4 poles screw terminal

Size (WxHxD): 125x125x100mm (4.95x4.95x3.95 inches)

Packaging: 1/box; 2.87lbs / 1.3Kg

## PST-480 Series

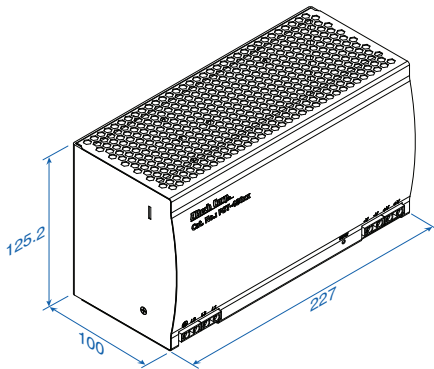

### TB1 Terminal Pin. No Assignment

Pin No.	Assignment
1	AC/L1
2	AC/L2
3	AC/L3
4	FG ⊕

### TB2 Terminal Pin. No Assignment

Pin No.	Assignment
1,2	DCOUTPUT +V
3,4	DCOUTPUT -V

Three phase input: 340-550V AC wide range, 480-780V DC  
1.7A @ 400V AC, 1.3A @ 500V AC

Connection: Input - 4 poles, Output - 4 poles screw terminal

Size (WxHxD): 227x125x100mm (9.95x4.95x3.95 inches)

Packaging: 1/box; 5.5lbs / 2.5Kg

## PST-960 Series

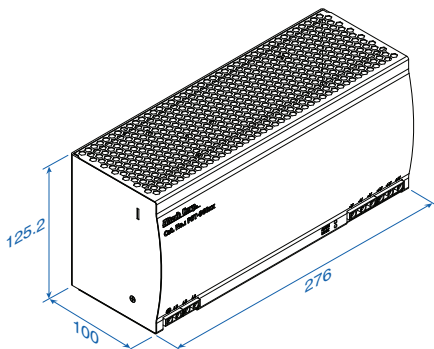

### TB1 Terminal Pin. No Assignment

Pin No.	Assignment
1	AC/L1
2	AC/L2
3	AC/L3
4	FG ⊕

### TB2 Terminal Pin. No Assignment

Pin No.	Assignment
1,2,3	DCOUTPUT +V
4,5,6	DCOUTPUT -V
7	GND
8	P (Current Share)

} Parallel Only

Three phase input: 340-550V AC wide range,  
2.4A @ 400V AC, 1.9A @ 500V AC

Connection: Input - 4 poles, Output - 6 poles screw terminal

Size (WxHxD): 276x125x100mm (10.87x4.95x3.95 inches)

Packaging: 1/box; 7.3lbs / 3.3Kg

*Note: All dimensions are in millimeters, to convert to inches multiply by 0.03937.*



# PST-240 Series Specifications



## Features:

- Three-Phase AC 340 ~ 550V wide range input
- High efficiency 89% and low dissipation
- Protections: Short Circuit / Overload / Overvoltage / Over temperature
- Cooling by free air convection
- Built-in constant current limiting circuit
- DIN rail mountable
- UL 508(industrial control equipment)approved
- EN61000-6-2(EN50082-2) industrial immunity level
- 100% full load burn-in test
- Fixed switching frequency at 70KHz
- 3 year warranty

## OUTPUT

Cat. No.	PST-24024	PST-24048
DC VOLTAGE	24V	48V
RATED CURRENT	10A	5A
CURRENT RANGE	0 ~ 10A	0 ~ 5A
RATED POWER	240W	240W
RIPPLE & NOISE (max)	80mVp-p	80mVp-p
Ripple & noise are measured at 20MHz of bandwidth by using a 12 twisted pair-wire terminated with a 0.1µF & 47µF parallel capacitor.		
VOLTAGE ADJ. RANGE	24 ~ 28V	48 ~ 55V
VOLTAGE TOLERANCE	±1.0%	±1.0%
Tolerance: includes set up tolerance, line regulation and load regulation.		
LINE REGULATION	±0.5%	±0.5%
LOAD REGULATION	±0.5%	±0.5%
SETUP, RISE, HOLD UP TIME	1200ms, 40ms, 20ms / 400VAC; 800ms, 40ms, 40ms / 500VAC at full load	

## INPUT

VOLTAGE RANGE	Three Phase 340 ~ 550VAC (Dual Phase operation possible)	480 ~ 780VDC
Dual phase operation: derating of 20% is required		
FREQUENCY RANGE	47 ~ 63Hz	
EFFICIENCY (Typ.)	89%	
AC CURRENT	0.95A / 400VAC; 0.75 / 500VAC	
INRUSH CURRENT (Typ.)	COLD START 50A	
LEAKAGE CURRENT	≤ 3.5 mA / 530VAC	

## PROTECTION

OVERLOAD	105 ~ 150% rated output power	
Protection type: Constant current limiting, recovers automatically after fault condition is removed		
OVERVOLTAGE	30 ~ 36V	59 ~ 66V
Protection type: Shut down overvoltage, re-power on to recover		
OVERTEMPERATURE	100°C ± 5°C (TSW) detect on heat sink of power switch	
Protection type: Shut down overvoltage, re-power automatically after temperature goes down		

## ENVIRONMENT

WORKING TEMP.	-20 ~ +70°C (Refer to output load derating curve)	
WORKING HUMIDITY	20 ~ 90% RH non-condensing	
STORAGE TEMP., HUMIDITY	-40 ~ +85°C, 10 ~ 95% RH	
TEMP. COEFFICIENT	±0.03% / °C (0 ~ 50°C)	
VIBRATION	10 ~ 500Hz, 2G 10min./1cycle, 60 min. each long X,Y, Z axes	
MOUNTING	Compliance to IEC60068-2-6	

## SAFETY & EMC

SAFETY STANDARDS	UL508 EN60950-1 compliant UL60950-1	
WITHSTAND VOLTAGE	I/P-O/P: 3KVAC I/P-FG: 1.5KVAC O/P-FG: 0.5KVAC	
ISOLATION RESISTANCE	I/P-O/P, I/P-FG, O/P-FG: 100M Ohms / 500VDC (25°C; 70% RH)	
EMI CONDUCTION & RADIATION	Compliance to EN55011 (CISPR11), EN55022 (CISPR22) Class B	
EMS IMMUNITY	Compliance to EN61000-4-2,3,4,5,6,8,11; ENV50204; EN61000-6-2; (EN50082-2), EN61204-3; heavy industry level; criteria A, The power supply is considered a component which will installed into a final equipment. The final equipment must be re-confirmed that it still meets EMC directives.	

## OTHERS

MTBF	114.6K hrs min. MIL-HDBK-217K (25°C)	
DIMENSION	125.5x125.2x100mm (WxHxD)	
PACKING	1.3Kg; 12pcs / 16.6Kg / 1.29CUFT	
All parameters NOT specially mentioned are measured at 400VAC input, rated load and 25°C of ambient temperature.		

## Mechanical Specification

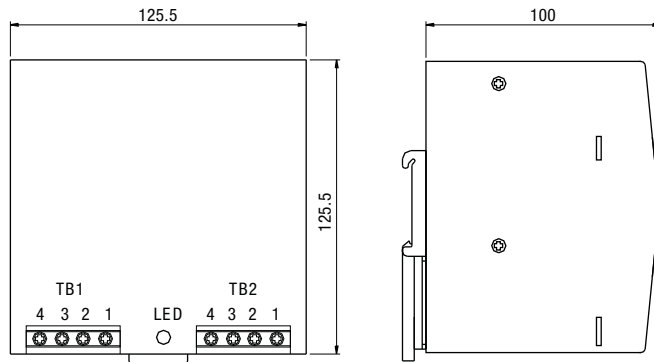

TB1 Terminal Pin. No Assignment

Pin No.	Assignment
1	FG $\oplus$
2	AC/L3
3	AC/L2
4	AC/L1

TB2 Terminal Pin. No Assignment

Pin No.	Assignment
1,2	DC OUTPUT +V
3,4	DC OUTPUT -V

## Block Diagram

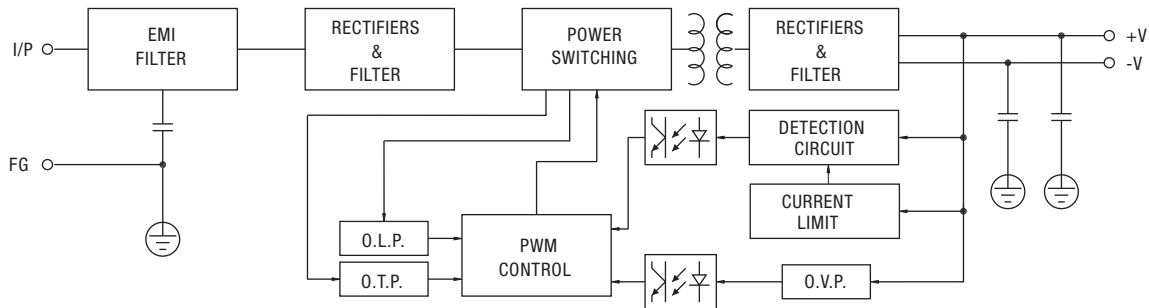

## Derating Curve

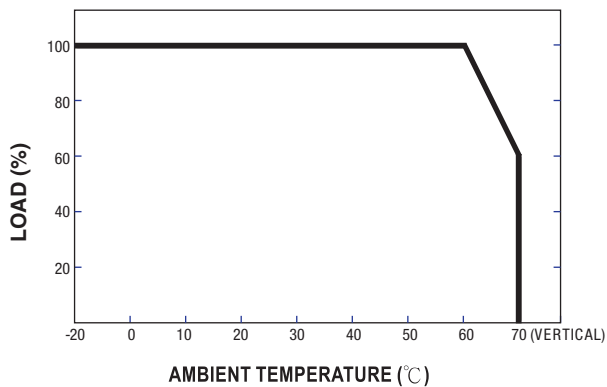

## Output Derating VS Input Voltage

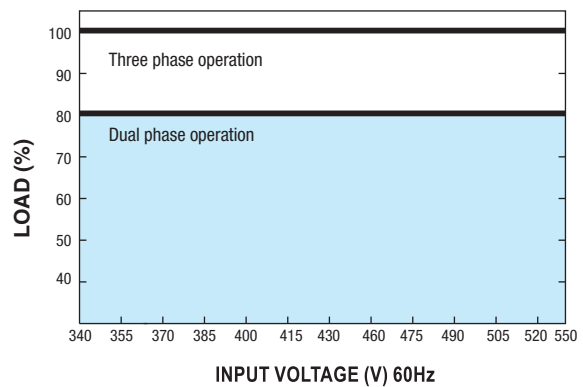

Note: All dimensions are in millimeters, to convert to inches multiply by 0.03937.



# PST-480 Series Specifications



## Features:

- Three-Phase AC 340 ~ 550V wide range input
- High efficiency 89% and low dissipation
- Protections: Short Circuit / Overload / Over Voltage / Overtemperature
- Cooling by free air convection
- Built-in constant current limiting circuit
- DIN rail mountable
- UL 508(industrial control equipment)approved
- EN61000-6-2(EN50082-2) industrial immunity level
- 100% full load burn-in test
- 3 year warranty

## OUTPUT

Cat. No.	PST-48024	PST-48048
DC VOLTAGE	24V	48V
RATED CURRENT	20A	10A
CURRENT RANGE	0 ~ 20A	0 ~ 10A
RATED POWER	480W	480W
RIPPLE & NOISE (max)	80mVp-p	80mVp-p
VOLTAGE ADJ. RANGE	24 ~ 28V	48 ~ 55V
VOLTAGE TOLERANCE	±1.0%	±1.0%
LINE REGULATION	±0.5%	±0.5%
LOAD REGULATION	±0.5%	±0.5%
SETUP, RISE, HOLD UP TIME	1200ms, 40ms, 16ms / 400VAC; 800ms, 40ms, 35ms / 500VAC at full load	
VOLTAGE RANGE	Three Phase 340 ~ 550VAC (Dual Phase operation possible) 480 ~ 780VDC Dual phase operation: derating of 20% is required	
FREQUENCY RANGE	47 ~ 63Hz	
EFFICIENCY (Typ.)	89%	90%
AC CURRENT	1.7A / 400VAC; 1.3A / 500VAC	
INRUSH CURRENT (Typ.)	COLD START 50A	
LEAKAGE CURRENT	≤ 3.5mA / 530VAC	
OVERLOAD	105 ~ 150% rated output power Protection type: Constant current limiting, recovers automatically after fault condition is removed	
OVERVOLTAGE	30 ~ 36V	59 ~ 66V
OVERTEMPERATURE	110°C ± 5°C (TSW) detect on heat sink of power switch Protection type: Shut down overvoltage, re-powers on to recover	
WORKING TEMP.	-20 ~ +70°C (Refer to output load derating curve)	
WORKING HUMIDITY	20 ~ 90% RH non-condensing	
STORAGE TEMP., HUMIDITY	-40 ~ +85°C, 10 ~ 95% RH	
TEMP. COEFFICIENT	±0.03% / °C (0 ~ 50°C)	
VIBRATION	10 ~ 500Hz, 2G 10min./1cycle, 60 min. each long X,Y, Z axes	
MOUNTING	Compliance to IEC60068-2-6	
SAFETY STANDARDS	UL508 EN60950-1 compliant UL60950-1	
WITHSTAND VOLTAGE	I/P-O/P: 3KVAC I/P-FG: 1.5KVAC O/P-FG: 0.5KVAC	
ISOLATION RESISTANCE	I/P-O/P, I/P-FG, O/P-FG: 100M Ohms / 500VDC (25°C: 70% RH)	
EMI CONDUCTION & RADIATION	Compliance to EN55011 (CISPR11), EN55022 (CISPR22), EN61204-3 Class B	
HARMONIC CURRENT	Compliance to EN61000-3-2,-3	
EMS IMMUNITY	Compliance to EN61000-4-2,3,4,5,6,8,11; ENV50204; EN61204-3; EN61000-6-2; (EN50082-2), heavy industry level; criteria A	
MTBF	91.1K hrs min. MIL-HDBK-217K (25°C)	
DIMENSION	227x125.2x100mm (WxHxD)	
PACKING	2.5Kg; 6pcs / 16Kg / 1.75CUFT	
	All parameters NOT specially mentioned are measured at 400VAC input, rated load and 25°C of ambient temperature.	

## INPUT

## PROTECTION

## ENVIRONMENT

## SAFETY & EMC

## OTHERS

## Mechanical Specification

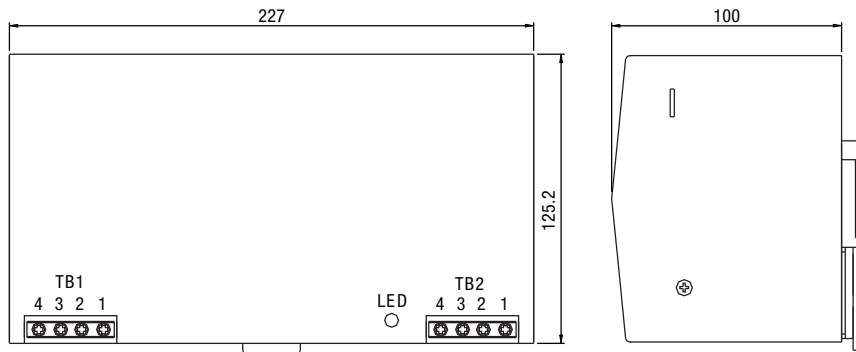

TB1 Terminal Pin. No Assignment

Pin No.	Assignment
1	AC/L1
2	AC/L2
3	AC/L3
4	FG

TB2 Terminal Pin. No Assignment

Pin No.	Assignment
1,2	DC OUTPUT +V
3,4	DC OUTPUT -V

## Block Diagram

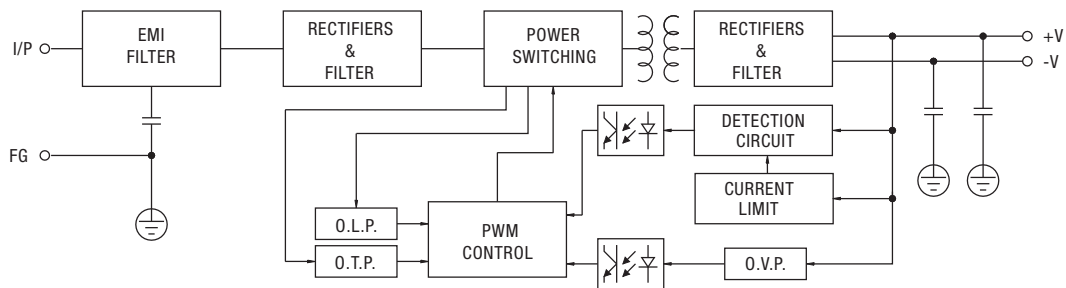

## Derating Curve

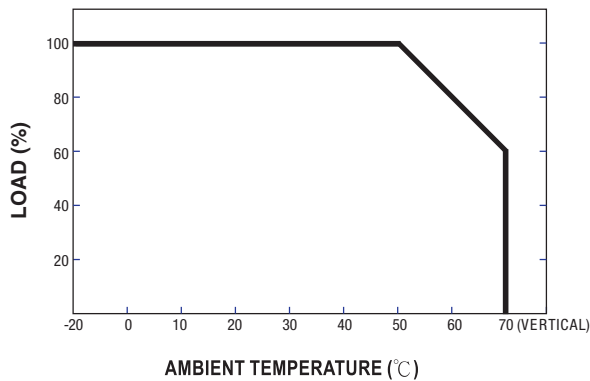

## Output Derating VS Input Voltage

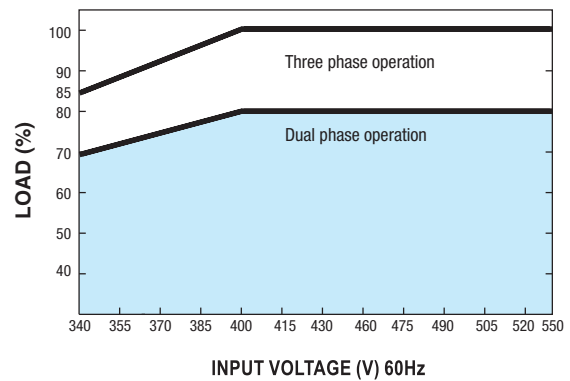

Note: All dimensions are in millimeters, to convert to inches multiply by 0.03937.



# PST-960 Series Specifications

**PARALLEL**



## Features:

- Three-Phase AC 340 ~ 550V wide range input
- High efficiency 91% and low dissipation
- Protections: Short Circuit / Overload / Over Voltage / Overtemperature
- Optional parallel function(1+1)
- Cooling by free air convection
- DIN rail mountable
- UL 508(industrial control equipment) approved
- EN61000-6-2(EN50082-2) industrial immunity level
- 100% full load burn-in test
- 3 year warranty

## OUTPUT

Cat. No.	PST-96024 / PST-960P24*	PST-96048 / PST-960P48*
DC VOLTAGE	24V	48V
RATED CURRENT	40A	20A
CURRENT RANGE	0 ~ 40A	0 ~ 20A
RATED POWER	960W	960W
RIPPLE & NOISE (max)	80mVp-p	80mVp-p
Ripple & noise are measured at 20MHz of bandwidth by using a 12 twisted pair-wire terminated with a 0.1µF & 47µF parallel capacitor.		
VOLTAGE ADJ. RANGE	24 ~ 28V	48 ~ 55V
VOLTAGE TOLERANCE	±1.0%	±1.0%
Tolerance: includes set up tolerance, line regulation and load regulation.		
LINE REGULATION	±0.5%	±0.5%
LOAD REGULATION	±0.5%	±0.5%
SETUP, RISE, HOLD UP TIME	200ms, 60ms, 14ms / 400VAC	200ms, 60ms, 30ms / 500VAC at full load
VOLTAGE RANGE	Three Phase 340 ~ 550VAC (Dual Phase operation possible in connecting L1, L3, FG)	
Dual phase operation (connecting L1, L3, FG) is allowed under certain derating to output load. Please refer to the derating curves for details.		
FREQUENCY RANGE	47 ~ 63Hz	
EFFICIENCY (Typ.)	91%	92%
AC CURRENT	2A / 400VAC;	1.6A / 500VAC
INRUSH CURRENT (Typ.)	COLD START 50A	
LEAKAGE CURRENT	≤ 3.5 mA / 530VAC	
OVERLOAD	105 ~ 125% rated output power	
Protection type: Constant current limiting, unit will shut down overvoltage after 3 sec., re-power on to recover		
OVERVOLTAGE	30 ~ 36V	59 ~ 66V
Protection type: Shut down overvoltage, re-power on to recover		
OVERTEMPERATURE	110°C ± 5°C (TSW1) detect on heat sink of power transistor	
85°C ± 5°C (TSW2) detect on heat sink of power diode		
Protection type: Shut down overvoltage, recovers automatically after temperature goes down		
WORKING TEMP.	-20 ~ +60°C (Refer to output load derating curve)	
WORKING HUMIDITY	20 ~ 90% RH non-condensing	
STORAGE TEMP., HUMIDITY	-40 ~ +85°C, 10 ~ 95% RH	
TEMP. COEFFICIENT	±0.03% / °C (0 ~ 50°C)	
VIBRATION	10 ~ 500Hz, 2G 10min./1cycle, 60 min. each long X,Y, Z axes	
MOUNTING	Compliance to IEC60068-2-6	
SAFETY STANDARDS	UL508 EN60950-1 compliant UL60950-1	
WITHSTAND VOLTAGE	I/P-O/P: 3KVAC I/P-FG: 1.5KVAC O/P-FG: 0.5KVAC	
ISOLATION RESISTANCE	I/P-O/P, I/P-FG, O/P-FG: 100M Ohms / 500VDC (25°C; 70% RH)	
EMI CONDUCTION & RADIATION	Compliance to EN55011 (CISPR11), EN55022 (CISPR22), EN61204-3 Class B	
HARMONIC CURRENT	Compliance to EN61000-3-2,-3	
EMS IMMUNITY	Compliance to EN61000-4-2,3,4,5,6,8,11; ENV50204; EN61204-3; EN61000-6-2; (EN50082-2), heavy industry level; criteria A	
The power supply is considered a component which will installed into a final equipment. The final equipment must be re-confirmed that it still meets EMC directives.		
MTBF	122.5K hrs min. MIL-HDBK-217K (25°C)	
DIMENSION	276x125.2x100mm (WxHxD)	
PACKING	3.3Kg; 4pcs / 14.2Kg / 1.14CUFT	
All parameters NOT specially mentioned are measured at 400VAC input, rated load and 25°C of ambient temperature.		

## INPUT

## PROTECTION

## ENVIRONMENT

## SAFETY & EMC

## OTHERS

\*Special order required.

For the latest on Altech Power Supply specifications please visit [www.altechcorp.com/power](http://www.altechcorp.com/power).

## Mechanical Specification

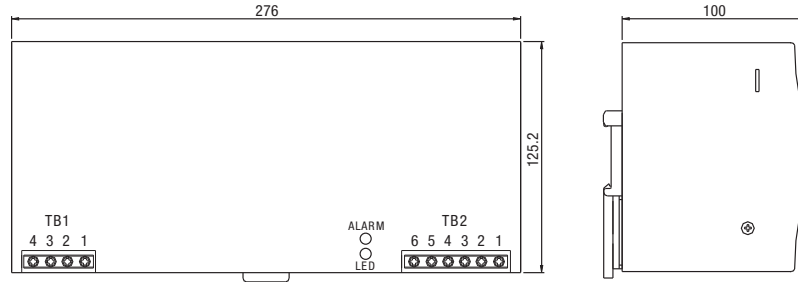

TB1 Terminal Pin. No Assignment

Pin No.	Assignment
1	ACL1
2	ACL2
3	ACL3
4	FG Ⓧ

TB2 Terminal Pin. No Assignment

Pin No.	Assignment
1,2,3	DCOUTPUT+ V
4,5,6	DCOUTPUT- V
7	P (Current Share)
8	P (Current Share)

} Parallel Only

## Optional Parallel Function (1+1) - (Special order required)

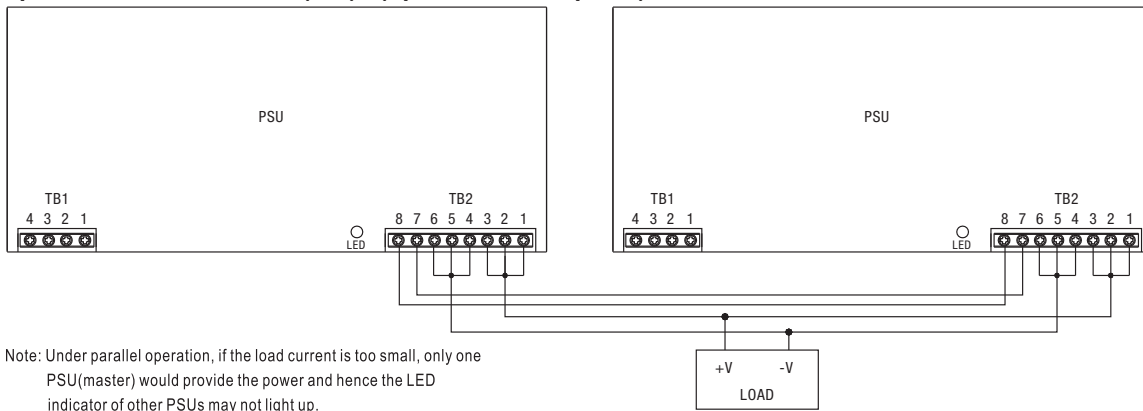

## Block Diagram

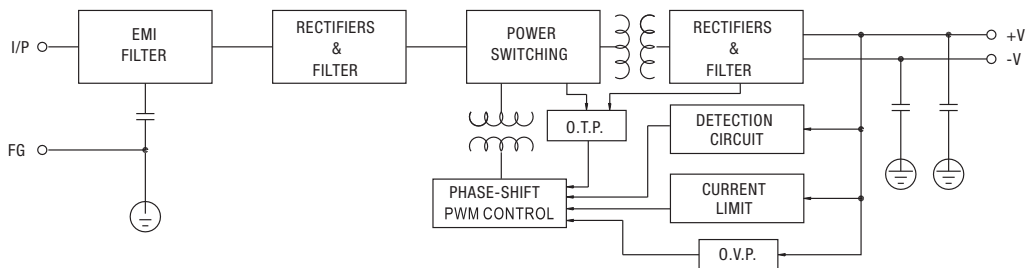

## Derating Curve

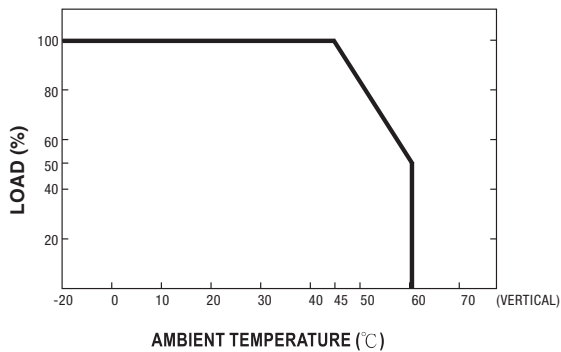

## Output Derating VS Input Voltage

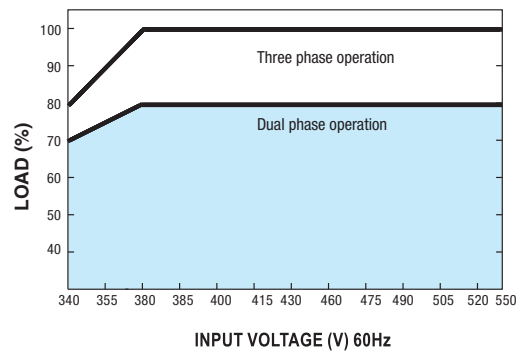

Note: All dimensions are in millimeters, to convert to inches multiply by 0.03937.





## High Efficiency Compact Housing Power Supply

This high performance single output compact DIN rail PS-C Series, with up-to-date circuit design, possess up to 94% of high efficiency and works within 110 ~150% rated output power for up to 3 seconds.

With built-in active PFC function, PS-C Series is a full range AC input switching power supply that fulfills the requirement of EN61000-3-2 for harmonic current. The compact design helps save the precious space on the rail and also makes it up to 50% smaller in size compare to its predecessor model PS-Series. Meanwhile, PS-C also have 5~9% higher efficiency than corresponding models of the PS-Series, which response to the trend of green power with energy saving concept.

Other standard functions include DC OK relay contact, on panel LED indicator, and protection for short-circuit, overload (constant current limiting, shut down if over 3 seconds), over voltage, and over temperature. To fulfill the requirements of marine and semi-conductor related usage, PS-C Series also complies with GL and SEMI F47 norms in addition to UL, CUL and CE certificates. Suitable applications are factory automation, semi-conductor fabrication equipment, marine related installation, and electro-mechanical applications.

- Input voltage range: 88-264V AC; 124-370V DC
- AC inrush current (typical):Cold start: 65A at 230V AC (PSC-240)
- DC adjustment range (typical): 12V: 12-14V, 24V: 24-28V, 48V: 48-55V,
- Overload protection (typical): 110%-150% rated output power
- Overvoltage protection (typical): 14-17V for 12V model (PSW-120),  
29-33V for 24V model  
56-65V for 48V model
- Over temperature protection: 95°C ± 5°C (PSC-120/240); 105°C ± 5°C
- Withstand voltage: I/P-O/P:3KV AC, I/P-FG:1.5KV AC, O/P-FG:0.5KV AC,
- Working temperature: -25 to +70°C (-4° to +158°F),  
refer to output derating curve
- Safety standards: UL508; EN60950-1 compliant
- EMC standards: Compliance to EN55022 class B,  
EN61000-4-2,3,4,5,6,8,11, ENV50204,  
EN61000-6-2, EN61204-3, heavy Industry level,  
SEMI F47, GL
- Military standard: MIL-HDBK-217K

# PS-C Series



## Features:

- High efficiency up to 94% and low power dissipation
- Universal AC Input / Full Range
- 150% peak load capability
- Built-in active PFC function, PF>0.93
- Protections: Short circuit / Overload / Overvoltage / Over temperature
- Cooling by free air convection
- Din rail mountable
- LED indicator for power on
- UL 508 (industrial control equipment) approved
- EN61000-6-2(EN50082-2) industrial immunity level
- 100% full load burn-in test
- Built-in DC OK relay contact
- 3 year warranty

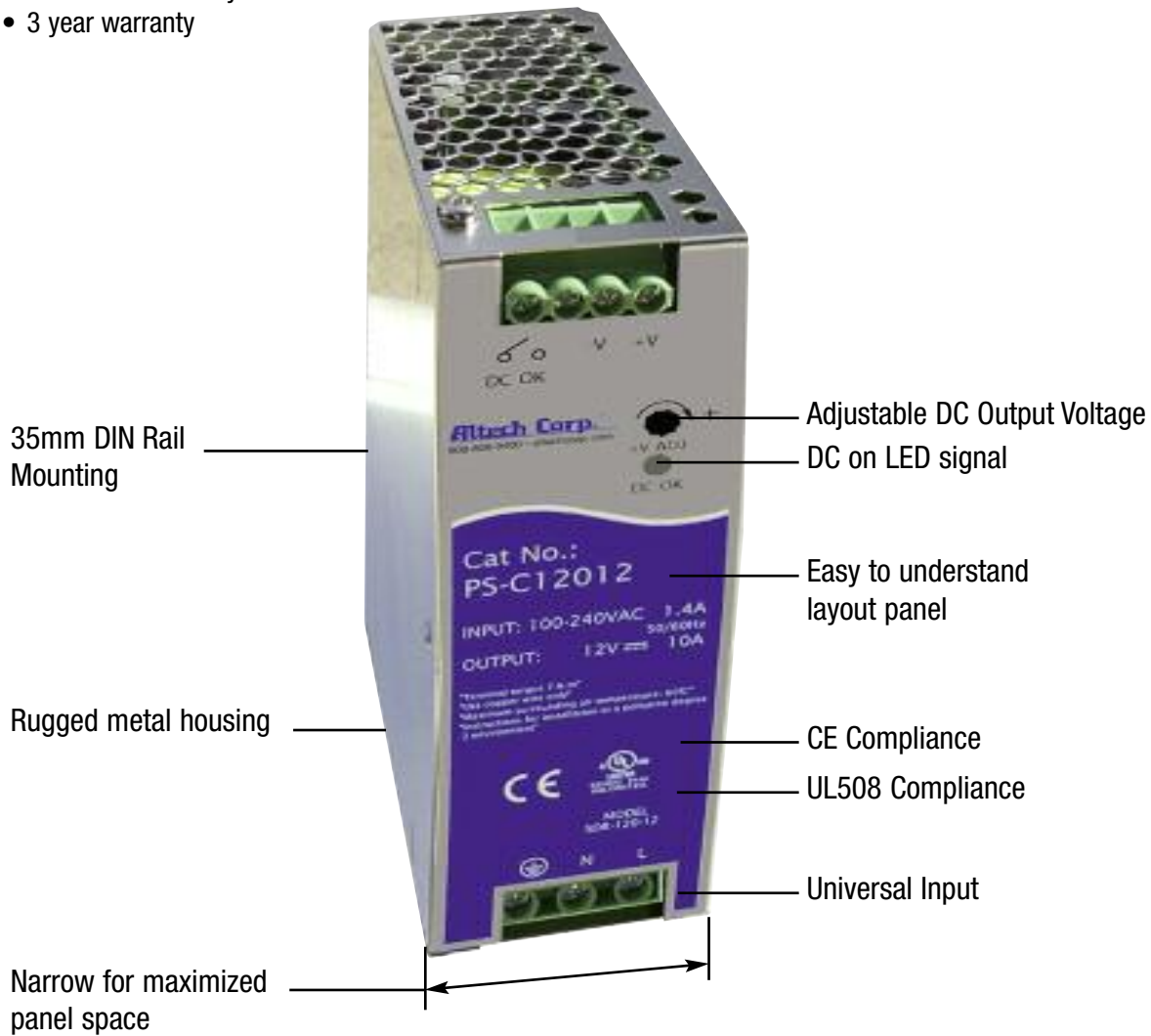

# 120-480W Single Phase

## COMPACT SIZE POWER SUPPLIES



### 120W Single Output DIN Rail Power Supply

Cat. No.	Output		Tol. %	Ripple & Noise	Efficiency	NOTES
	V DC	A				
PS-C12012	12V DC	10A	±1%	100 mVp-p	89%	
PS-C12024	24V DC	5A	±1%	100 mVp-p	91%	
PS-C12048	48V DC	2.5A	±1%	120 mVp-p	91%	



### 240W Single Output DIN Rail Power Supply

Cat. No.	Output		Tol. %	Ripple & Noise	Efficiency	NOTES
	V DC	A				
PS-C24024	24V DC	10A	±1%	100 mVp-p	94%	
PS-C24048	48V DC	5A	±1%	120 mVp-p	94%	



### 480W Single Output DIN Rail Power Supply

Cat. No.	Output		Tol. %	Ripple & Noise	Efficiency	NOTES
	V DC	A				
PS-C48024	24V DC	20A	±1%	100 mVp-p	94%	
PS-C48048	48V DC	10A	±1%	120 mVp-p	94%	



### 480W Single Output DIN Rail Power Supply with PFC and Parallel Function (1+7)

Cat. No.	Output		Tol. %	Ripple & Noise	Efficiency	NOTES
	V DC	A				
PS-C480P24	24V DC	20A	±1%	100 mVp-p	94%	
PS-C480P48	48V DC	10A	±1%	120 mVp-p	94%	

**PARALLEL**

# SPECIFICATIONS

## PS-C120 Series

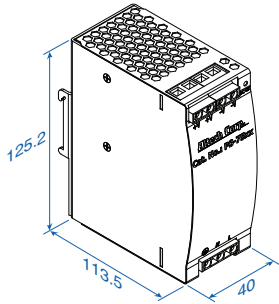

### Terminal Pin. No Assign. (TB1)

Pin No.	Assignment
1	FG ⊕
2	AC/N
3	AC/L

### Terminal Pin. No Assign. (TB2)

Pin No.	Assignment
1,2	Relay Contact
3	DC OUTPUT -V
4	DC OUTPUT +V

Universal Input: 88-264V AC, 124-370V DC full range,

1.4A/115V AC, 0.7A/230V AC

Connection: Input - 3 poles, Output – 4 poles screw terminal

Size (WxHxD): 40x125.2x113.5mm (1.57x4.93x4.47 inches)

Packaging: 1/box; 1.48lbs / 0.67Kg

## PS-C240 Series

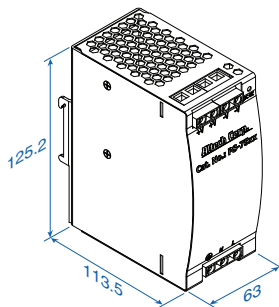

### Terminal Pin. No Assign. (TB1)

Pin No.	Assignment
1	FG ⊕
2	AC/N
3	AC/L

### Terminal Pin. No Assign. (TB2)

Pin No.	Assignment
1,2	Relay Contact
3,4	DC OUTPUT -V
5,6	DC OUTPUT +V

Switch select Input: 88-264V AC, 124-370V DC range,

2.6A/115V AC, 1.3A/230V AC

Connection: Input - 3 poles, Output – 6 poles screw terminal

Size (WxHxD): 63x125.2x113.5mm (2.48x4.93x4.47 inches)

Packaging: 1/box; 2.27lbs / 1.03Kg

## PS-C480 Series

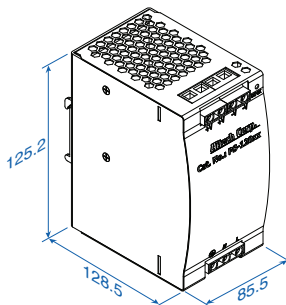

### Terminal Pin. No Assign. (TB1)

Pin No.	Assignment
1	FG ⊕
2	AC/N
3	AC/L

### Terminal Pin. No Assign. (TB2)

Pin No.	Assignment
1,2	DC OUTPUT +V
3,4	DC OUTPUT -V
5,6	Relay Contact
7,8	NC

### For Parallel Model Terminal Pin. No Assign. (TB1)

Pin No.	Assignment
1	FG ⊕
2	AC/N
3	AC/L

### For Parallel Model Terminal Pin. No Assign. (TB2)

Pin No.	Assignment
1,2	DC OUTPUT +V
3,4	DC OUTPUT -V
5,6	Relay Contact
7	P+ (current share)*
8	P- (current share)*

\* Only parallel function.

Universal Input: 90-264V AC, 127-370V DC full range,

5A/115V AC, 2.5A/230V AC

Connection: Input - 3 poles, Output – 12 poles screw terminal

Size (WxHxD): 85.5x125.2x128.5mm (3.37x4.93x5.06 inches)

Packaging: 1/box; 3.53lbs / 1.6Kg

*Note: All dimensions are in millimeters, to convert to inches multiply by 0.03937.*



# PS-C120 Series Specifications



## Features:

- High efficiency 91% and low power dissipation
- 150% peak load capability
- Built-in active PFC function, PF>0.93
- Protections: Short Circuit / Overload / Over Voltage / Overtemperature
- Cooling by free air convection
- DIN rail mountable
- UL 508 (industrial control equipment) approved
- EN61000-6-2 (EN50082-2) industrial immunity level
- Built-in DC OK relay contact
- 100% full load burn-in test
- 3 year warranty

## OUTPUT

Cat. No.	PS-C12012	PS-C12024	PS-C12048
DC VOLTAGE	12V	24V	48V
RATED CURRENT	10A	5A	2.5A
CURRENT RANGE	0 ~ 10A	0 ~ 5A	0 ~ 2.5A
RATED POWER	120W	120W	120W
PEAK CURRENT	15A	7.5A	3.75A
PEAK POWER	180W (3 sec.)		
	3 seconds max., please refer to peak loading curves		
RIPPLE & NOISE (max)	100mVp-p	100mVp-p	120mVp-p
	Ripple & noise are measured at 20MHz of bandwidth by using a 12 twisted pair-wire terminated with a 0.1µF & 47µF parallel capacitor.		
VOLTAGE ADJ. RANGE	12 ~ 14V	24 ~ 28V	48 ~ 55V
VOLTAGE TOLERANCE	±1.0%	±1.0%	±1.0%
	Tolerance: includes set up tolerance, line regulation and load regulation.		
LINE REGULATION	±0.5%	±0.5%	±0.5%
LOAD REGULATION	±1.0%	±1.0%	±1.0%
SETUP, RISE TIME	1500ms, 60ms / 230VAC	3000ms, 60ms / 115VAC at full load	
HOLD UP TIME (Typ.)	20ms / 230VAC	20ms / 115VAC at full load	

## INPUT

VOLTAGE RANGE	88 ~ 264VAC	124 ~ 370VDC	
	Derating may be needed under low input voltages, please check the derating curve for more detail		
FREQUENCY RANGE	47 ~ 63Hz		
POWER FACTOR (Typ.)	0.93 / 230VAC	0.96 / 115VAC at full load	
EFFICIENCY (Typ.)	89%	91%	90.50%
AC CURRENT (Typ.)	1.4A / 115VAC	0.7A / 230VAC	
INRUSH CURRENT (Typ.)	35A / 115VAC	70A / 230VAC	
LEAKAGE CURRENT	≤ 1 mA / 240VAC		

## PROTECTION

OVERLOAD	Normally works within 110 ~ 150% rated output power for more than 3 seconds and then shut down overvoltage ≥ 150% rated power, constant current limiting with auto-recovery within 3 seconds and shut down overvoltage after 3 seconds		
OVERVOLTAGE	14 ~ 17V	29 ~ 33V	56 ~ 65V
	Protection type: Shut down overvoltage, re-power on to recover		
OVERTEMPERATURE	95°C ± 5°C (TSW: detect on heat sink of power switch)		
	Protection type: Shut down overvoltage, re-power automatically after temperature goes down		
DC OK RELAY CONTACT RATINGS (max.)	60VDC / 0.3A	30VDC / 1A	30VAC / 0.5A RESISTIVE LOAD

## ENVIRONMENT

WORKING TEMP.	-25 ~ +70°C (Refer to output load derating curve)		
	Installation clearances: 40mm on top, 20mm on the bottom, 5mm on the left and right side are recommended when loaded permanently with full power. In case the adjacent device is a heat source, 15mm clearance is recommended		
WORKING HUMIDITY	20 ~ 95% RH non-condensing		
STORAGE TEMP., HUMIDITY	-40 ~ +85°C, 10 ~ 95% RH		
TEMP. COEFFICIENT	±0.03% / °C (0 ~ 50°C)		
VIBRATION	10 ~ 500Hz, 2G 10min./1cycle, 60 min. each long X,Y, Z axes		
MOUNTING	Compliance to IEC60068-2-6		

## SAFETY & EMC

SAFETY STANDARDS	UL508 EN60950-1 compliant		
WITHSTAND VOLTAGE	I/P-O/P: 3KVAC I/P-FG: 1.5KVAC O/P-FG: 0.5KVAC O/P-DC OK: 0.5KVAC		
ISOLATION RESISTANCE	I/P-O/P, I/P-FG, O/P-FG: ≥100M Ohms/500VDC (25°C; 70% RH)		
EMI CONDUCTION & RADIATION	Compliance to EN55022 (CISPR22) Class B		
HARMONIC CURRENT	Compliance to EN61000-3-2,-3		
EMS IMMUNITY	Compliance to EN61000-4-2,3,4,5,6,8,11; EN50204; EN55024; EN61000-6-2; (EN50082-2); EN61204-3; heavy industry level; criteria A, SEMI F47, GL approved		
	The power supply is considered a component which will installed into a final equipment. The final equipment must be re-confirmed that it still meets EMC directives.		

## OTHERS

MTBF	289.9K hrs min. MIL-HDBK-217K (25°C)		
DIMENSION	40x125.2x113.5mm (WxHxD)		
PACKING	0.67Kg; 20pcs / 14.4Kg / 1.16CUFT		
	All parameters NOT specially mentioned are measured at 230V AC input, rated load and 25°C of ambient temperature.		

## Mechanical Specification

Terminal Pin No. Assignment (TB1)

Pin No.	Assignment
1	FG ⊕
2	AC/N
3	AC/L

Terminal Pin No. Assignment (TB2)

Pin No.	Assignment
1,2	Relay Contact
3	DC OUTPUT -V
4	DC OUTPUT +V

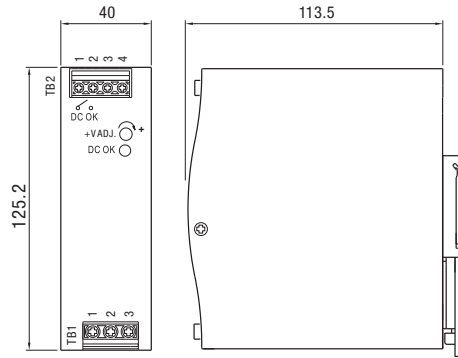

## DC OK Relay Contact

Contact Close	When the output voltage reaches the adjusted output voltage.
Contact Open	When the output voltage drop below 90% output voltage.
Contact Ratings (max.)	30V/1A resistive load

## Block Diagram

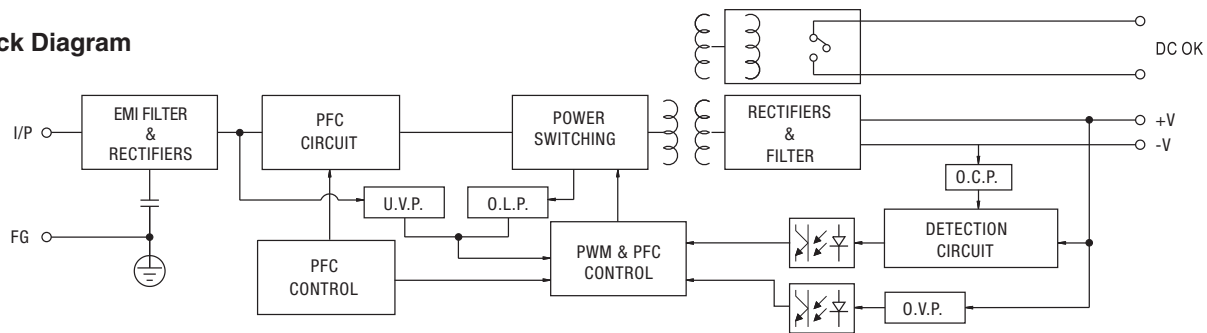

## Peak Loading

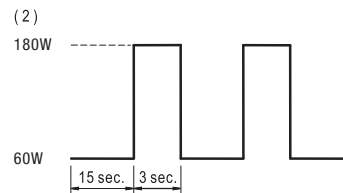
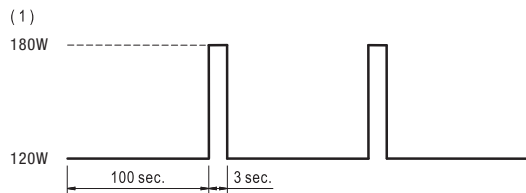

## Derating Curve

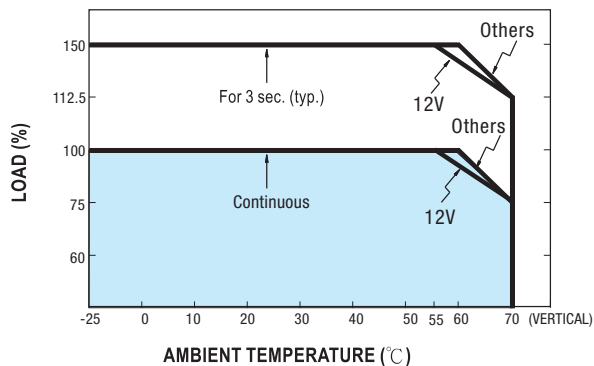

## Output Derating VS Input Voltage

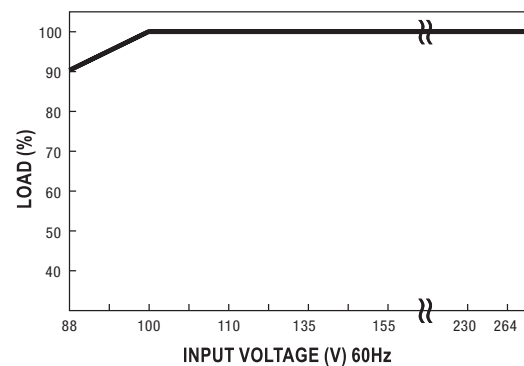

Note: All dimensions are in millimeters, to convert to inches multiply by 0.03937.



# PS-C240 Series Specifications



## Features:

- High efficiency 94% and low power dissipation
- 150% peak load capability
- Built-in active PFC function, PF>0.93
- Protections: Short Circuit / Overload / Over Voltage / Overtemperature
- Cooling by free air convection
- DIN rail mountable
- UL 508 (industrial control equipment) approved
- EN61000-6-2(EN50082-2) industrial immunity level
- Built-in DC OK relay contact
- 100% full load burn-in test
- 3 year warranty

## OUTPUT

Cat. No.	PS-C24024	PS-C24048
----------	-----------	-----------

DC VOLTAGE	24V	48V
RATED CURRENT	10A	5A
CURRENT RANGE	0 ~ 10A	0 ~ 5A
RATED POWER	240W	240W
PEAK CURRENT	15A	7.5A
PEAK POWER	360W (3 sec.)	
	3 seconds max., please refer to peak loading curves	
RIPPLE & NOISE (max)	100mVp-p	120mVp-p
	Ripple & noise are measured at 20MHz of bandwidth by using a 12 twisted pair-wire terminated with a 0.1µF & 47µF parallel capacitor.	
VOLTAGE ADJ. RANGE	24 ~ 28V	48 ~ 55V
VOLTAGE TOLERANCE	±1.0%	±1.0%
	Tolerance: includes set up tolerance, line regulation and load regulation.	
LINE REGULATION	±0.5%	±0.5%
LOAD REGULATION	±1.0%	±1.0%
SETUP, RISE TIME	1500ms, 60ms / 230VAC	3000ms, 60ms / 115VAC at full load
HOLD UP TIME (Typ.)	20ms / 230VAC	20ms / 115VAC at full load

## INPUT

VOLTAGE RANGE	88 ~ 264VAC	124 ~ 370VDC
	Derating may be needed under low input voltages, please check the derating curve for more detail	
FREQUENCY RANGE	47 ~ 63Hz	
POWER FACTOR (Typ.)	0.93 / 230VAC	0.99 / 115VAC at full load
EFFICIENCY (Typ.)	94%	
	After 30 minutes of burn-in.	
AC CURRENT (Typ.)	2.6A / 115VAC	1.3A / 230VAC
INRUSH CURRENT (Typ.)	33A / 115VAC	65A / 230VAC
LEAKAGE CURRENT	≤ 1 mA / 240VAC	

## PROTECTION

OVERLOAD	Normally works within 110 ~ 150% rated output power for more than 3 seconds and then shut down overvoltage with auto-recovery	
	≥ 150% rated power, constant current limiting with auto-recovery within 2 seconds and shut down overvoltage after 2 seconds	
OVERVOLTAGE	29 ~ 33V	56 ~ 65V
	Protection type: Shut down overvoltage with auto-recovery	
OVERTEMPERATURE	95°C ± 5°C (TSW: detect on heat sink of power switch)	
	Protection type: Shut down overvoltage, re-power automatically after temperature goes down	

## ENVIRONMENT

DC OK RELAY CONTACT RATINGS (max.)	60VDC / 0.3A	30VDC / 1A	30VAC / 0.5A RESISTIVE LOAD
WORKING TEMP.	-25 ~ +70°C (Refer to output load derating curve)		
	Installation clearances: 40mm on top, 20mm on the bottom, 5mm on the left and right side are recommended when loaded permanently with full power. In case the adjacent device is a heat source, 15mm clearance is recommended.		
WORKING HUMIDITY	20 ~ 95% RH non-condensing		
STORAGE TEMP., HUMIDITY	-40 ~ +85°C, 10 ~ 95% RH		
TEMP. COEFFICIENT	±0.03% / °C (0 ~ 50°C)		
VIBRATION	10 ~ 500Hz, 2G 10min./1cycle, 60 min. each long X,Y, Z axes		
MOUNTING	Compliance to IEC60068-2-6		

## SAFETY & EMC

SAFETY STANDARDS	UL508 EN60950-1 compliant		
WITHSTAND VOLTAGE	I/P-O/P: 3KVAC	I/P-FG: 1.5KVAC	O/P-FG: 0.5KVAC O/P-DC OK: 0.5KVAC
ISOLATION RESISTANCE	I/P-O/P, I/P-FG, O/P-FG: ≥100M Ohms / 500VDC (25°C; 70% RH)		
EMI CONDUCTION & RADIATION	Compliance to EN55022 (CISPR22) Class B		
HARMONIC CURRENT	Compliance to EN61000-3-2, -3		
EMS IMMUNITY	Compliance to EN61000-4-2,3,4,5,6,8,11; ENV50204; EN55024; EN61000-6-2; (EN50082-2), EN61204-3; heavy industry level; criteria A, SEMI F47, GL approved		
	The power supply is considered a component which will be installed into a final equipment. The final equipment must be re-confirmed that it still meets EMC directives.		

## OTHERS

MTBF	169.3K hrs min.	MIL-HDBK-217K (25°C)
DIMENSION	63x125.2x113.5mm (WxHxD)	
PACKING	1.03Kg; 12pcs / 13.4Kg / 1.06CUFT	
	All parameters NOT specially mentioned are measured at 230V AC input, rated load and 25°C of ambient temperature.	



## Mechanical Specification

Terminal Pin No. Assignment (TB1)

Pin No.	Assignment
1	FG Ⓧ
2	AC/N
3	AC/L

Terminal Pin No. Assignment (TB2)

Pin No.	Assignment
1,2	Relay Contact
3,4	DC OUTPUT +V
5,6	DC OUTPUT -V

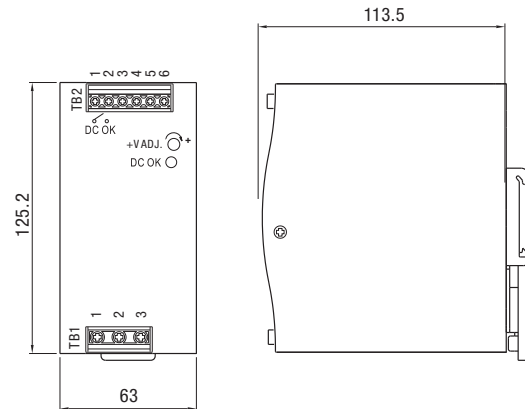

## DC OK Relay Contact

Contact Close	When the output voltage reaches the adjusted output voltage.
Contact Open	When the output voltage drop below 90% output voltage.
Contact Ratings (max.)	30V/1A resistive load

## Block Diagram

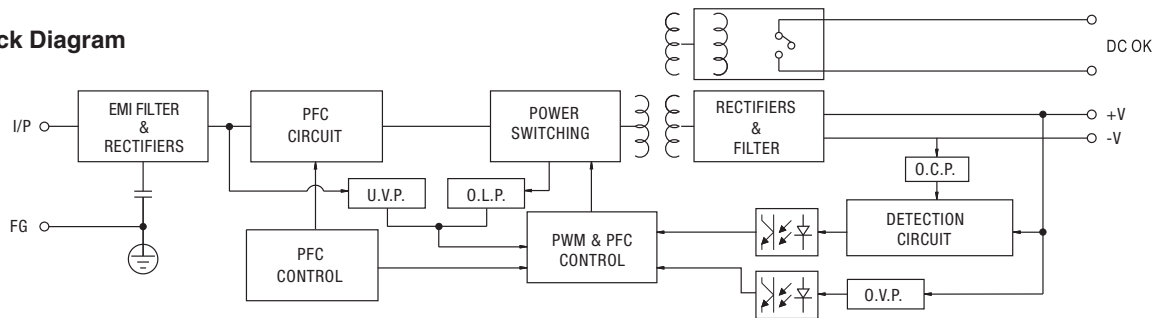

## Peak Loading

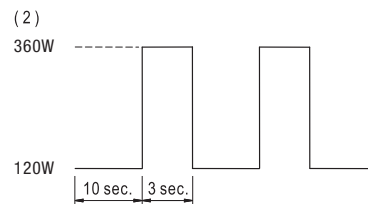
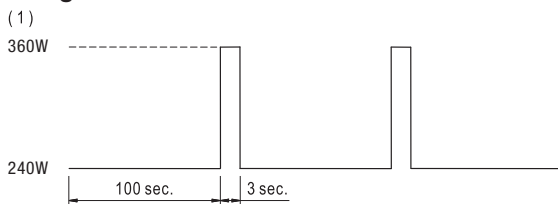

## Derating Curve

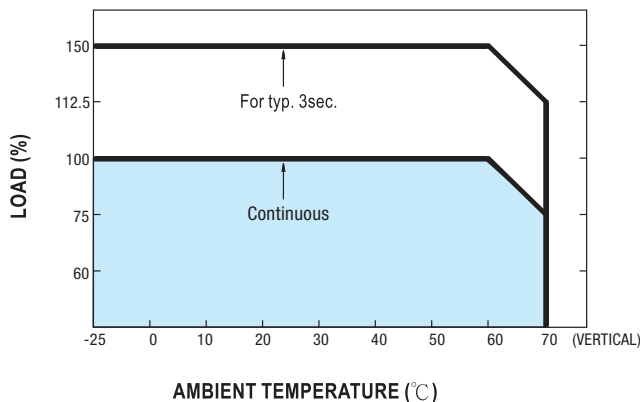

## Output Derating VS Input Voltage

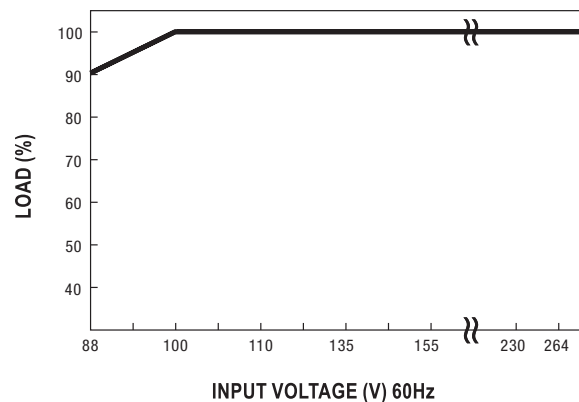

Note: All dimensions are in millimeters, to convert to inches multiply by 0.03937.



# PS-C480 Series Specifications



## Features:

- High efficiency 94% and low power dissipation
- 150% peak load capability
- Built-in active PFC function, PF>0.94
- Protections: Short Circuit / Overload / Over Voltage / Overtemperature
- Cooling by free air convection
- Built-in constant current limiting circuit
- DIN rail mountable
- UL 508(industrial control equipment) approved
- EN61000-6-2(EN50082-2) industrial immunity level
- Built-in DC OK relay contact
- 100% full load burn-in test
- 3 year warranty

## OUTPUT

Cat. No.	PS-C48024	PS-C48048
DC VOLTAGE	24V	48V
RATED CURRENT	20A	10A
CURRENT RANGE	0 ~ 20A	0 ~ 10A
RATED POWER	480W	480W
PEAK CURRENT	30A	15A
PEAK POWER	720W (3 sec.)	
	3 seconds peak power max. and the average output power should not exceed the rate power	
RIPPLE & NOISE (max)	100mVp-p	120mVp-p
	Ripple & noise are measured at 20MHz of bandwidth by using a 12 twisted pair-wire terminated with a 0.1µF & 47µF parallel capacitor.	
VOLTAGE ADJ. RANGE	24 ~ 28V	48 ~ 55V
VOLTAGE TOLERANCE	±1.2%	±1.0%
	Tolerance: includes set up tolerance, line regulation and load regulation.	
LINE REGULATION	±0.5%	±0.5%
LOAD REGULATION	±1.0%	±1.0%
SETUP, RISE TIME	1500ms, 150ms / 230VAC	3000ms, 150ms / 115VAC at full load
HOLD UP TIME (Typ.)	14ms / 230VAC at full load	

## INPUT

VOLTAGE RANGE	90 ~ 264VAC	127 ~ 370VDC
	Derating may be needed under low input voltages, please check the derating curve for more detail	
FREQUENCY RANGE	47 ~ 63Hz	
POWER FACTOR (Typ.)	0.94 / 230VAC	0.99 / 115VAC at full load
EFFICIENCY (Typ.)	94%	
	After 30 minutes of burn-in	
AC CURRENT (Typ.)	5A / 115VAC	2.5A / 230VAC
INRUSH CURRENT (Typ.)	40A / 115VAC	80A / 230VAC
LEAKAGE CURRENT	≤ 0.8 mA / 240VAC	

## PROTECTION

OVERLOAD	Normally works within 110 ~ 150% rated output power for more than 3 seconds and then shut down overvoltage with auto-recovery ≥ 150% rated power, constant current limiting with auto-recovery within 2 seconds and shut down overvoltage after 2 seconds	
OVERVOLTAGE	29 ~ 33V	56 ~ 65V
	Protection type: Shut down overvoltage with auto-recovery on re-power on to recovery	
OVERTEMPERATURE	105°C ± 5°C (TSW: detect on heat sink of power switch) Protection type: Shut down overvoltage, re-power automatically after temperature goes down	

## ENVIRONMENT

DC OK RELAY CONTACT RATINGS (max.)	60VDC / 0.3A; 30VDC / 1A; 30VAC / 0.5A resistive load	
WORKING TEMP.	-25 ~ +70°C (Refer to output load derating curve) Installation clearances: 40mm on top, 20mm on the bottom, 5mm on the left and right side are recommended when loaded permanently with full power. In case the adjacent device is a heat source, 15mm clearance is recommended.	
WORKING HUMIDITY	20 ~ 95% RH non-condensing	
STORAGE TEMP., HUMIDITY	-40 ~ +85°C, 10 ~ 95% RH	
TEMP. COEFFICIENT	±0.03% / °C (0 ~ 50°C)	
VIBRATION	10 ~ 500Hz, 2G 10min./1cycle, 60 min. each long X,Y, Z axes	
MOUNTING	Compliance to IEC60068-2-6	

## SAFETY & EMC

SAFETY STANDARDS	UL508 EN60950-1 compliant		
WITHSTAND VOLTAGE	I/P-O/P: 3KVAC	I/P-FG: 1.5KVAC	O/P-FG: 0.5KVAC O/P-DC OK: 0.5KVAC
ISOLATION RESISTANCE	I/P-O/P, I/P-FG, O/P-FG: ≥100M Ohms/500VDC (25°C; 70% RH)		
EMI CONDUCTION & RADIATION	Compliance to EN55022 (CISPR22) Class B		
HARMONIC CURRENT	Compliance to EN61000-3-2,-3		
EMS IMMUNITY	Compliance to EN61000-4-2,3,4,5,6,8,11; ENV50204; EN55024; EN61000-6-2; (EN50082-2), EN61204-3; heavy industry level; criteria A, SEMI F47, GL approved		
	The power supply is considered a component which will installed into a final equipment. The final equipment must be re-confirmed that it still meets EMC directives.		

## OTHERS

MTBF	112.9K hrs min.	MIL-HDBK-217K (25°C)
DIMENSION	85.5x125.2x128.5mm (WxHxD)	
PACKING	1.6Kg; 8pcs / 13.8Kg / 0.9CUFT	
	All parameters NOT specially mentioned are measured at 230V AC input, rated load and 25°C of ambient temperature.	

## Mechanical Specification

Terminal Pin No. Assignment (TB1)

Pin No.	Assignment
1	FG ⊕
2	AC/N
3	AC/L

Terminal Pin No. Assignment (TB2)

Pin No.	Assignment
1,2	DC OUTPUT +V
3,4	DC OUTPUT -V
5,6	Relay Contact
7,8	NC

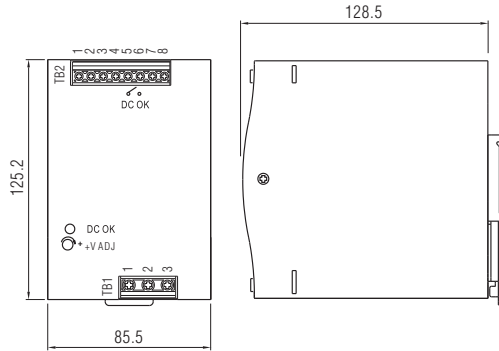

## DC OK Relay Contact

Contact Close	When the output voltage reaches the adjusted output voltage.
Contact Open	When the output voltage drop below 90% output voltage.
Contact Ratings (max.)	30V/1A resistive load

## Block Diagram

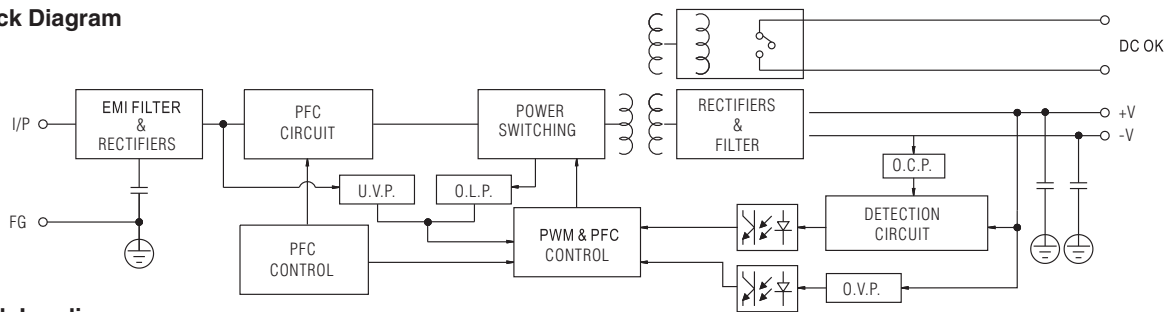

## Peak Loading

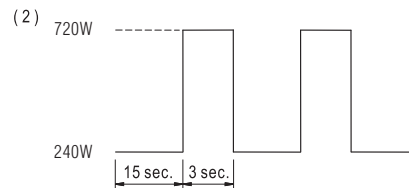
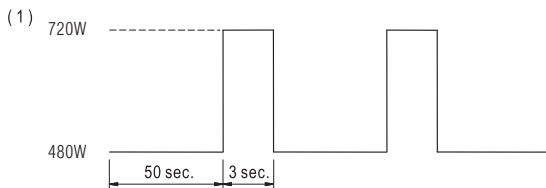

## Derating Curve

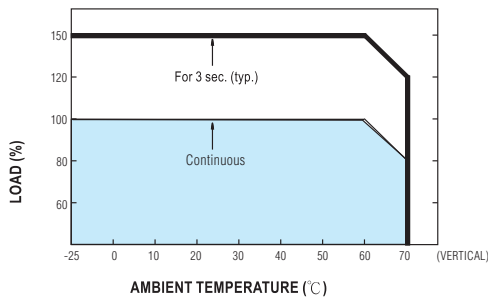

## Output Derating VS Input Voltage

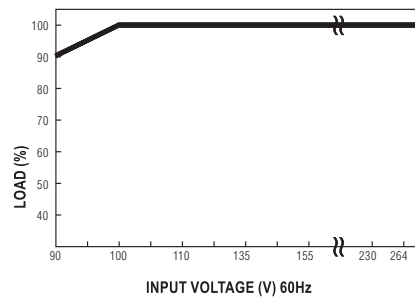

Note: All dimensions are in millimeters, to convert to inches multiply by 0.03937.



# PS-C480P Series With Parallel Function Specifications



**PARALLEL**

## Features:

- High efficiency 94% and low power dissipation
- 150% peak load capability
- Built-in active PFC function, PF>0.94
- Protections: Short Circuit / Overload / Over Voltage / Overtemperature
- Cooling by free air convection
- Built-in constant current limiting circuit
- DIN rail mountable
- Current sharing up to 380W (1+7)
- UL 508(industrial control equipment)approved
- EN61000-6-2(EN50082-2) industrial immunity level
- Built-in DC OK relay contact
- 100% full load burn-in test
- 3 year warranty

## OUTPUT

Cat. No.	PS-C480P24	PS-C480P48
DC VOLTAGE	24V	48V
RATED CURRENT	20A	10A
CURRENT RANGE	0 ~ 20A	0 ~ 10A
RATED POWER	480W	480W
PEAK CURRENT	30A	15A
PEAK POWER	720W (3 sec.)	
	3 seconds peak power max. and the average output power should not exceed the rate power	
RIPPLE & NOISE (max)	100mVp-p	120mVp-p
	Ripple & noise are measured at 20MHz of bandwidth by using a 12 twisted pair-wire terminated with a 0.1µF & 47µF parallel capacitor.	
VOLTAGE ADJ. RANGE	24 ~ 28V	48 ~ 55V
VOLTAGE TOLERANCE	±1.2%	±1.0%
	Tolerance: includes set up tolerance, line regulation and load regulation.	
LINE REGULATION	±0.5%	±0.5%
LOAD REGULATION	±1.0%	±1.0%
SETUP, RISE, HOLD UP TIME	1500ms, 150ms, 14ms / 230VAC	3000ms, 150ms / 115VAC at full load

## INPUT

VOLTAGE RANGE	90 ~ 264VAC 127 ~ 370VDC
	Derating may be needed under low input voltages, please check the derating curve for more detail
FREQUENCY RANGE	47 ~ 63Hz
POWER FACTOR (Typ.)	0.94 / 230VAC 0.99 / 115VAC at full load
EFFICIENCY (Typ.)	94%
	After 30 minutes of burn-in.
AC CURRENT (max.)	5A / 115VAC 2.5A / 230VAC
INRUSH CURRENT (Typ.)	40A / 115VAC 80A / 230VAC
LEAKAGE CURRENT	≤ 0.6 mA / 240VAC

## PROTECTION

OVERLOAD	Normally works within 110 ~ 150% rated output power for more than 3 seconds and then shut down overvoltage with auto-recovery ≥ 150% rated power, constant current limiting with auto-recovery within 2 seconds and shut down overvoltage after 2 seconds
OVERVOLTAGE	29 ~ 33V 56 ~ 65V
	Protection type: Shut down overvoltage with auto-recovery on re-power on to recovery
OVERTEMPERATURE	105°C ± 5°C (TSW: detect on heat sink of power switch) Protection type: Shut down overvoltage, re-power automatically after temperature goes down
CURRENT SHARING	Please see function diagram
DC OK RELAY CONTACT RATINGS (max.)	60VDC / 0.3A; 30VDC / 1A; 30VAC / 0.5A resistive load

## ENVIRONMENT

WORKING TEMP.	-25 ~ +70°C (Refer to output load derating curve) Installation clearances: 40mm on top, 20mm on the bottom, 5mm on the left and right side are recommended when loaded permanently with full power. In case the adjacent device is a heat source, 15mm clearance is recommended.
WORKING HUMIDITY	20 ~ 95% RH non-condensing
STORAGE TEMP., HUMIDITY	-40 ~ +85°C, 10 ~ 95% RH
TEMP. COEFFICIENT	±0.03% / °C (0 ~ 50°C)
VIBRATION	10 ~ 500Hz, 2G 10min./1cycle, 60 min. each long X,Y, Z axes
MOUNTING	Compliance to IEC60068-2-6

## SAFETY & EMC

SAFETY STANDARDS	UL508 EN60950-1 compliant
WITHSTAND VOLTAGE	I/P-O/P: 3KVAC I/P-FG: 1.5KVAC O/P-FG: 0.5KVAC O/P-DC OK: 0.5KVAC
ISOLATION RESISTANCE	I/P-O/P, I/P-FG, O/P-FG: ≥100M Ohms/500VDC (25°C; 70% RH)
EMI CONDUCTION & RADIATION	Compliance to EN55022 (CISPR22) Class B
HARMONIC CURRENT	Compliance to EN61000-3-2,-3
EMS IMMUNITY	Compliance to EN61000-4-2,3,4,5,6,8,11; ENV50204; EN55024; EN61000-6-2; (EN50082-2), EN61204-3; heavy industry level; criteria A, SEMI F47, GL approved The power supply is considered a component which will installed into a final equipment. The final equipment must be re-confirmed that it still meets EMC directives.

## OTHERS

MTBF	112.9K hrs min. MIL-HDBK-217K (25°C)
DIMENSION	85.5x125.2x128.5mm (WxHxD)
PACKING	1.6Kg; 8pcs / 13.8Kg / 0.9CUFT
	All parameters NOT specially mentioned are measured at 230V AC input, rated load and 25°C of ambient temperature.

For the latest on Altech Power Supply specifications please visit [www.altechcorp.com/power](http://www.altechcorp.com/power).

## Mechanical Specification

Terminal Pin No. Assignment (TB1)

Pin No.	Assignment
1	FG ⊕
2	AC/N
3	AC/L

Terminal Pin No. Assignment (TB2)

Pin No.	Assignment
1,2	DC OUTPUT +V
3,4	DC OUTPUT -V
5,6	Relay Contact
7	P+ (current share)
8	P- (current share)

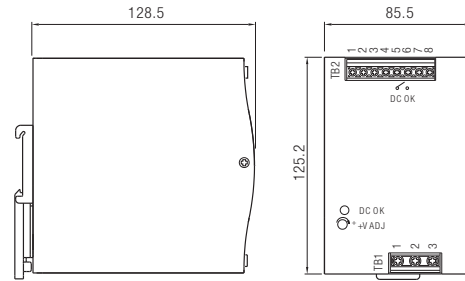

## DC OK Relay Contact

Contact Close	When the output voltage reaches the adjusted output voltage.
Contact Open	When the output voltage drop below 90% output voltage.
Contact Ratings (max.)	30V/1A resistive load

## Peak Loading

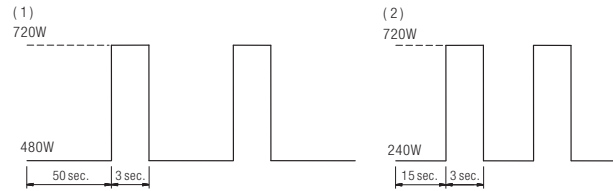

## Block Diagram

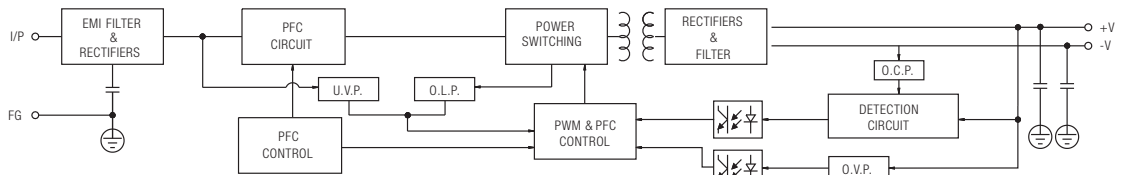

## Function Diagram

### 1. Current sharing

- (1) Parallel operation is available by connecting the units shown as below (P+, P- are connected mutually in parallel):
- (2) The voltage difference among each output should be minimized that less than 2% is required.
- (3) The total output current must not exceed the value determined by the following equation (Output current at parallel operation) = (The rated current per unit) x (Number of unit) x 0.9.
- (4) In parallel operation 8 units is the maximum, please consult the manufacture for other applications.
- (5) When in parallel operation, the minimum output load should be greater than 3% of total output load.  
(Min. load > 3% rated current per unit x number of unit)

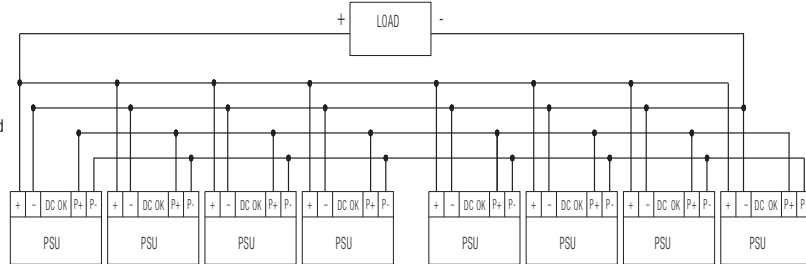

## Derating Curve

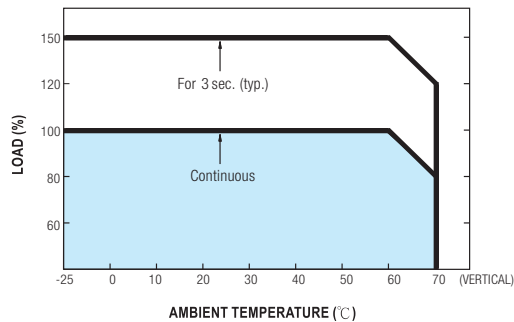

## Output Derating VS Input Voltage

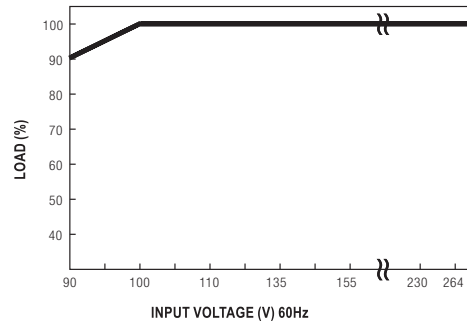

Note: All dimensions are in millimeters, to convert to inches multiply by 0.03937.



## Wide Input Compact Housing Power Supply

With the PSW family, AC/DC compact DIN rail switching power supplies with single phase wide input range, Altech further expanded the power supply line. Built-in active PFC function, these high efficient power units meet the harmonic current limitation per EN61000-3-2. Equipped with 180 to 550Vac single phase wide input range, they can be used in general power system applications with single phase 230Vac input or can capture two phases from the 220~550Vac three-phase power system, which can greatly increase the flexibility of system deployment.

With up-to-date circuit design PSW series possess up to 93% of extremely high efficiency and can provide 100% power continuously at 50°C by only free air convection, or operate under 70°C ambient temperature by suitable power derating. The compact design in width helps save the precious space on the rail and also makes it up to 50% smaller in size compare to its predecessor models. Meanwhile, with wider input range the PSW series also has 3% higher efficiency than corresponding models, which response to the trend of green power with energy saving concept. Other standard functions include DC OK relay contact alarm signal output, front panel DC voltage adjustment , as well as protection for short-circuit, overload (constant current mode, shut down if over 3 seconds), over voltage, and over temperature. The PSW series comply with UL508, IEC60950-1 (CB), and CE certificates and also meet the EMC requirements of heavy industrial immunity level (EN61000-6-2). Suitable applications include industrial control system, semi-conductor fabrication equipment, factory automation, electro-mechanical applications, and marine related installation.

- Input voltage range: 180~550V AC; 254-780V DC
- AC inrush current (typical): Cold start: 50A at 400V AC
- DC adjustment range (typical): 12V: 12-15V, 24V: 24-29V, 48V: 48-58V,
- Overload protection (typical): 105%-130% rated output
- Over-voltage protection (typical): 16-18V for 12V model (PSW-120),  
31-37V for 24V model; 60-67V for 48V model
- Setup, rise, time (typical): 2000ms, 70ms at full load and 230V AC (PSW-120)  
2000ms, 150ms at full load and 230V AC (PSW240/480)
- Withstand voltage: I/P-O/P:3KV AC, I/P-FG:1.5KV AC, O/P-FG:0.5KV AC,
- Working temperature: -20 to +70°C (-4° to +158°F),  
refer to output derating curve (PSW-120)
- DC OK signal Relay contact
- Safety standards: UL508 (PSW-240 pending)
- EMC standards: Compliance to EN55011 (CISPR11), EN55022 class B,  
EN61000-4-2,3,4,5,6,8,11, ENV50204, EN55024,  
EN61000-6-2, EN61204-3, heavy Industry Level criteria A
- Military standard: MIL-HDBK-217K

# PSW Series



- Single and two phase wide input range 180~550VAC
- Universal AC Input / Full Range
- High efficiency up to 93% and low power dissipation
- Protections: Short circuit / Overload / Overvoltage / Over temperature
- Cooling by free air convection
- DIN rail mountable
- UL 508 (industrial control equipment) approved
- EN61000-6-2(EN50082-2) industrial immunity level
- Built-in DC OK relay contact
- 100% full load burn-in test
- 3 year warranty





# 120-480W Single Phase

## WIDE INPUT POWER SUPPLIES



### 120W Single Output DIN Rail Power Supply

Cat. No.	Output V DC	A	Tol. %	Ripple & Noise	Efficiency	NOTES
PSW-12012	12V DC	10A	±1.5%	120 mVp-p	89.5%	
PSW-12024	24V DC	5A	±1%	120 mVp-p	91%	
PSW-12048	48V DC	2.5A	±1%	150 mVp-p	92%	



### 240W Single Output DIN Rail Power Supply

Cat. No.	Output V DC	A	Tol. %	Ripple & Noise	Efficiency	NOTES
PSW-24024	24V DC	10A	±1%	120 mVp-p	90%	
PSW-24048	48V DC	5A	±1%	120 mVp-p	90%	



### 480W Single Output DIN Rail Power Supply

Cat. No.	Output V DC	A	Tol. %	Ripple & Noise	Efficiency	NOTES
PSW-48024	24V DC	20A	±1%	100 mVp-p	94%	
PSW-48048	48V DC	10A	±1%	120 mVp-p	94%	

# SPECIFICATIONS

## PSW-120 Series

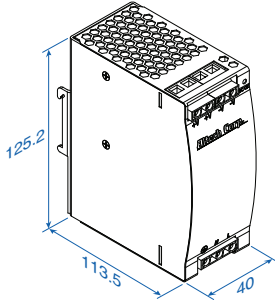

Terminal Pin. No Assign. (TB1)

Pin No.	Assignment
1	FG ⊕
2	AC/L2
3	AC/L1

Terminal Pin. No Assign. (TB2)

Pin No.	Assignment
1,2	Relay Contact
3	DC OUTPUT -V
4	DC OUTPUT +V

Universal Input: 180-550V AC, 254-780V DC full range,  
0.55A/400V AC, 1.2A/230V AC

Connection: Input - 3 poles, Output – 4 poles screw terminal  
Size (WxHxD): 40x125.2x113.5mm (1.57x4.93x4.47 inches)

Packaging: 1/box; 1.433lbs / 0.65Kg

## PSW-240 Series

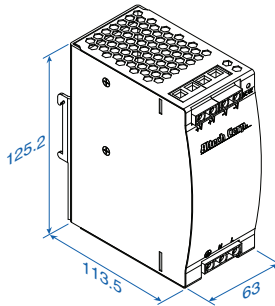

Terminal Pin. No Assign. (TB1)

Pin No.	Assignment
1	FG ⊕
2	AC/L2
3	AC/L1

Terminal Pin. No Assign. (TB2)

Pin No.	Assignment
1,2	Relay Contact
3,4	DC OUTPUT -V
5,6	DC OUTPUT +V

Universal Input: 180-550V AC, 254-780V DC full range,  
1A/400V AC, 2A/230V AC

Connection: Input - 3 poles, Output – 6 poles screw terminal  
Size (WxHxD): 63x125.2x113.5mm (2.48x4.93x4.47 inches)

Packaging: 1/box; 2.337lbs / 1.06Kg

## PSW-480 Series

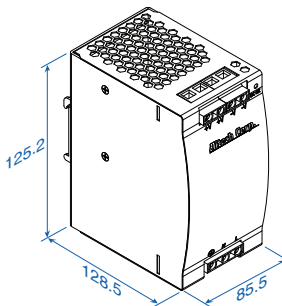

Terminal Pin. No Assign. (TB1)

Pin No.	Assignment
1	FG ⊕
2	AC/L2
3	AC/L1

Terminal Pin. No Assign. (TB2)

Pin No.	Assignment
1,2	DC OUTPUT +V
3,4	DC OUTPUT -V
5,6	Relay Contact

Universal Input: 180-550V AC, 254-780V DC full range,  
1.6A/400V AC, 4A/230V AC

Connection: Input - 3 poles, Output – 6 poles screw terminal  
Size (WxHxD): 85.5x125.2x128.5mm (3.37x4.93x5.06 inches)

Packaging: 1/box; 3.748lbs / 1.7Kg

*Note: All dimensions are in millimeters, to convert to inches multiply by 0.03937.*



# PSW-120 Series Specifications



## Features:

- Single and two phase wide input range 180 ~ 550VAC
- Protections: Short Circuit / Overload / Over Voltage / Overtemperature
- Cooling by free air convection
- Built-in constant current limiting circuit
- DIN rail mountable
- UL508 (industrial control equipment) approved
- EN61000-6-2 (EN50082-2) industrial immunity level
- 100% full load burn-in test
- Built-in DC OK relay contact
- 3 year warranty

## OUTPUT

Cat. No.	PSW-12012	PSW-12024	PSW-12048
DC VOLTAGE	12V	24V	48V
RATED CURRENT	10A	5A	2.5A
CURRENT RANGE	0 ~ 10A	0 ~ 5A	0 ~ 2.5A
RATED POWER	120W	120W	120W
RIPPLE & NOISE (max)	120mVp-p	120mVp-p	150mVp-p
Ripple & noise are measured at 20MHz of bandwidth by using a 12 twisted pair-wire terminated with a 0.1µF & 47µF parallel capacitor.			
VOLTAGE ADJ. RANGE	12 ~ 15V	24 ~ 29V	48 ~ 58V
VOLTAGE TOLERANCE	±1.5%	±1.0%	±1.0%
Tolerance: includes set up tolerance, line regulation and load regulation.			
LINE REGULATION	±0.5%	±0.5%	±0.5%
LOAD REGULATION	±0.5%	±0.5%	±0.5%
SETUP, RISE HOLD UP TIME	2000ms, 70ms, 50ms / 400VAC	2000ms, 70ms, 10ms / 230VAC at full load	
Length of set up time is measured at cold first start. Turning ON/OFF the power supply very quick may lead to increase of the set up time.			

## INPUT

VOLTAGE RANGE	180 ~ 550VAC	254 ~ 780VDC	
FREQUENCY RANGE	47 ~ 63Hz		
EFFICIENCY (Typ.)	89.5% / 400V	91% / 400V	92% / 400V
AC CURRENT	0.55A / 400VAC	1.2A / 230VAC	
INRUSH CURRENT (Typ.)	COLD START 50A		
LEAKAGE CURRENT	≤ 3.5 mA / 530VAC		

## PROTECTION

OVERLOAD	105 ~ 130% rated output power		
Protection type: Constant current limiting, recovers automatically after fault condition is removed			
OVERVOLTAGE	16 ~ 18V	31 ~ 37V	60 ~ 67V
Protection type: Shut down overvoltage, re-power on to recover			
OVERTEMPERATURE	105°C ± 5°C (12V), 110°C ± 5°C (24V) (TSW1) detect on heat sink of power switch transistor; 100°C ± 5°C (48V) (TSW1) detect on heat sink of power diode		
Protection type: Shut down overvoltage, re-power automatically after temperature goes down			
DC OK SIGNAL	Relay contact rating (max.): 30V / 1A resistive		

## ENVIRONMENT

WORKING TEMP.	-25 ~ +70°C (Refer to output load derating curve)		
WORKING HUMIDITY	20 ~ 90% RH non-condensing		
STORAGE TEMP., HUMIDITY	-40 ~ +85°C, 10 ~ 95% RH		
TEMP. COEFFICIENT	±0.03% / °C (0 ~ 50°C)		
VIBRATION	10 ~ 500Hz, 2G 10min./1cycle, 60 min. each long X,Y, Z axes Mounting clip: Compliance to IEC60068-2-6		

## SAFETY & EMC

SAFETY STANDARDS	UL508 approved IEC60950-1 compliant		
WITHSTAND VOLTAGE	I/P-O/P: 3KVAC I/P-FG:1.5KVAC O/P-FG:0.5KVAC O/P-DC OK:0.5KVAC		
ISOLATION RESISTANCE	I/P-O/P, I/P-FG, O/P-FG: 100M Ohms/500VDC (25°C; 70% RH)		
EMI CONDUCTION & RADIATION	Compliance to EN55011 (CISPR11), EN55022 (CISPR22), EN61204-3 Class B		
EMS IMMUNITY	Compliance to EN61000-4-2,3,4,5,6,8,11; ENV50204; EN61204-3; EN61000-6-2; (EN50082-2), heavy industry level; criteria A,  The power supply is considered a component which will installed into a final equipment. The final equipment must be re-confirmed that it still meets EMC directives.		

## OTHERS

MTBF	268K hrs min. MIL-HDBK-217K (25°C)		
DIMENSION	40x125.2x113.5mm (WxHxD)		
PACKING	0.65Kg; 20pcs / 14Kg / 1.16CUFT		
All parameters NOT specially mentioned are measured at 230V AC input, rated load and 25°C of ambient temperature.			

## Mechanical Specification

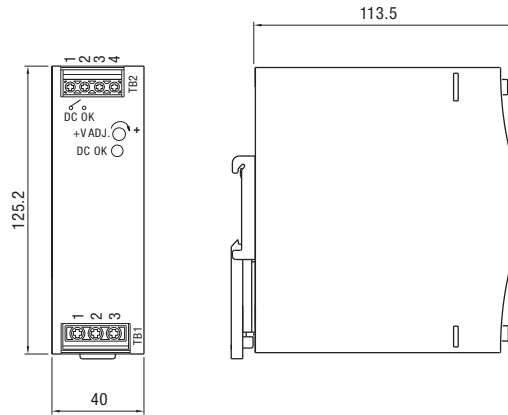

Terminal Pin No. Assignment (TB1)

Pin No.	Assignment
1	FG ⊕
2	AC/L2
3	AC/L1

Terminal Pin No. Assignment (TB2)

Pin No.	Assignment
1,2	Relay Contact
3	DC OUTPUT -V
4	DC OUTPUT +V

## Block Diagram

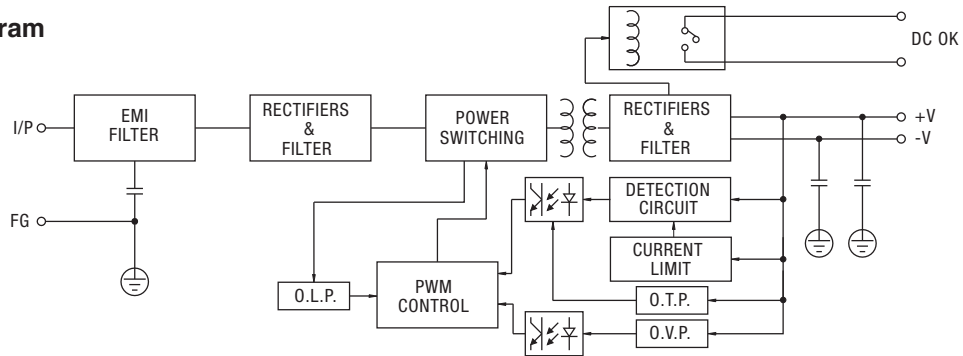

## Derating Curve

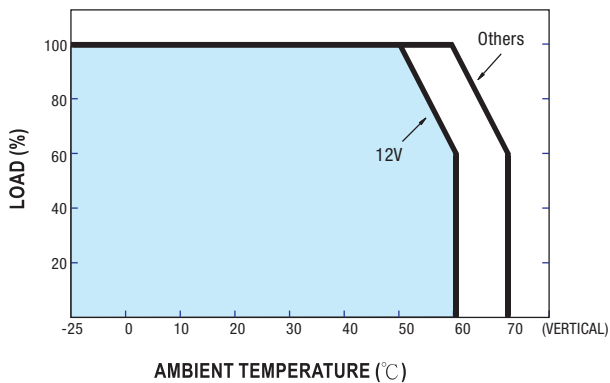

## Static Characteristics

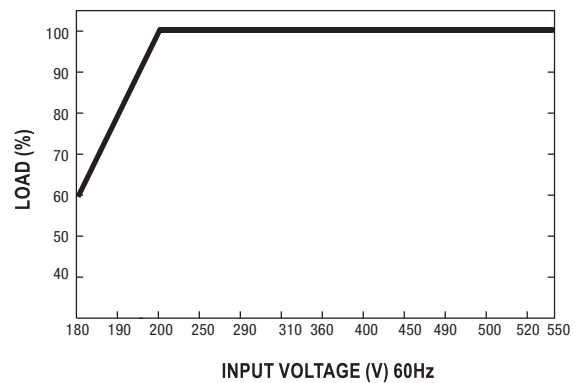

Note: All dimensions are in millimeters, to convert to inches multiply by 0.03937.



# PSW-240 Series Specifications



## Features:

- Single and two phase wide input range 180~550VAC
- High efficiency 91% and low power dissipation
- Protections: Short Circuit / Overload / Over Voltage / Overtemperature
- Cooling by free air convection
- DIN rail mountable
- UL 508 (industrial control equipment) approved
- EN61000-6-2 (EN50082-2) industrial immunity level
- Built-in DC OK relay contact
- 100% full load burn-in test
- 3 year warranty

## OUTPUT

### Cat. No.

### PSW-24024

### PSW-24048

DC VOLTAGE  
RATED CURRENT  
CURRENT RANGE  
RATED POWER  
RIPPLE & NOISE (max)

24V  
10A  
0 ~ 10A  
240W  
150mVp-p

48V  
5A  
0 ~ 5A  
240W  
150mVp-p

VOLTAGE ADJ. RANGE  
VOLTAGE TOLERANCE

24 ~ 28V  
±1.0%

48 ~ 55V  
±1.0%

Tolerance: includes set up tolerance, line regulation and load regulation.

LINE REGULATION  
LOAD REGULATION  
SETUP, RISE, HOLD UP TIME

±0.5%  
±1.0%  
800ms, 150ms, 18ms / 400VAC

±0.5%  
±1.0%

1500ms, 150ms, 18ms / 230VAC at full load

VOLTAGE RANGE 180 ~ 550VAC 254 ~ 780VDC

Derating may be needed under low input voltage. Please check the derating curve for more details

FREQUENCY RANGE  
EFFICIENCY (Typ.)

47 ~ 63Hz  
91%

AC CURRENT  
INRUSH CURRENT (Typ.)  
LEAKAGE CURRENT

1A / 400VAC 2A / 230VAC  
COLD START 50A  
≤ 3.5 mA / 530VAC

## INPUT

## PROTECTION

OVERLOAD

105 ~ 130% rated output power

Protection type: Constant current limiting, unit will shut down after 3 sec.; auto recovery after 1 minute if the fault condition is removed

OVERVOLTAGE

29 ~ 33V 56 ~ 65V

Protection type: Shut down overvoltage, re-power on to recovery  
Under over-voltage condition, if input voltage ≤ 200VAC, the power supply will shut down and then may have auto-recovery after several seconds

OVERTEMPERATURE

90°C ± 5°C (TSW) detect on heat sink of power switch

Protection type: Shut down overvoltage, recovers automatically after temperature goes down

DC OK RELAY CONTACT RATINGS (max.)

60VDC / 0.3A; 30VDC / 1A; 30VAC / 0.5A resistive load

## ENVIRONMENT

WORKING TEMP.

-30 ~ +70°C (Refer to output load derating curve)

Installation clearances: 40mm on top, 20mm on the bottom, 5mm on the left and right side are recommended when loaded permanently with full power. In case the adjacent device is a heat source, 15mm clearance is recommended.

WORKING HUMIDITY  
STORAGE TEMP., HUMIDITY  
TEMP. COEFFICIENT

20 ~ 95% RH non-condensing  
-40 ~ +85°C; 10 ~ 95% RH  
±0.03% / °C (0 ~ 50°C)

VIBRATION  
MOUNTING

10 ~ 500Hz, 2G 10min./1cycle, 60 min. each long X,Y, Z axes  
Compliance to IEC60068-2-6

## SAFETY & EMC

SAFETY STANDARDS

UL508 approved  
IEC 60950-1 compliant  
Design refer to GL

WITHSTAND VOLTAGE  
ISOLATION RESISTANCE  
EMI CONDUCTION & RADIATION  
HARMONIC CURRENT  
EMS IMMUNITY

I/P-O/P: 3KVAC I/P-FG: 1.5KVAC O/P-FG :0.5KVAC O/P-DC OK: 0.5KVAC  
I/P-O/P, I/P-FG, O/P-FG: ≥ 100M Ohms / 500VDC (25°C; 70% RH)  
EN55022 (CISPR22), Class B  
Compliance to EN61000-3-2,-3  
Compliance to EN61000-4-2,3,4,5,6,8,11; ENV50204; EN 55024; EN61000-6-2; (EN50082-2); EN61204-3; heavy industry level; criteria A approved;  
The power supply is considered a component which will installed into a final equipment. The final equipment must be re-confirmed that it still meets EMC directives.

## OTHERS

MTBF  
DIMENSION  
PACKING

141.1K hrs min. MIL-HDBK-217K (25°C)  
63x125.2x113.5mm (WxHxD)  
1.06Kg; 12pcs / 13.7Kg / 1.06CUFT

All parameters NOT specially mentioned are measured at 400VAC input, rated load and 25°C of ambient temperature.

## Mechanical Specification

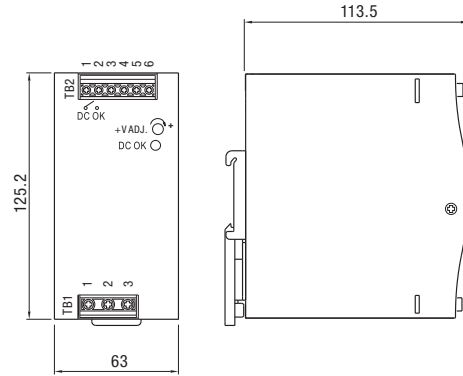

Terminal Pin No. Assignment (TB1)

Pin No.	Assignment
1	FG $\oplus$
2	AC/L2
3	AC/L1

Terminal Pin No. Assignment (TB2)

Pin No.	Assignment
1,2	Relay Contact
3,4	DC OUTPUT +V
5,6	DC OUTPUT -V

## Block Diagram

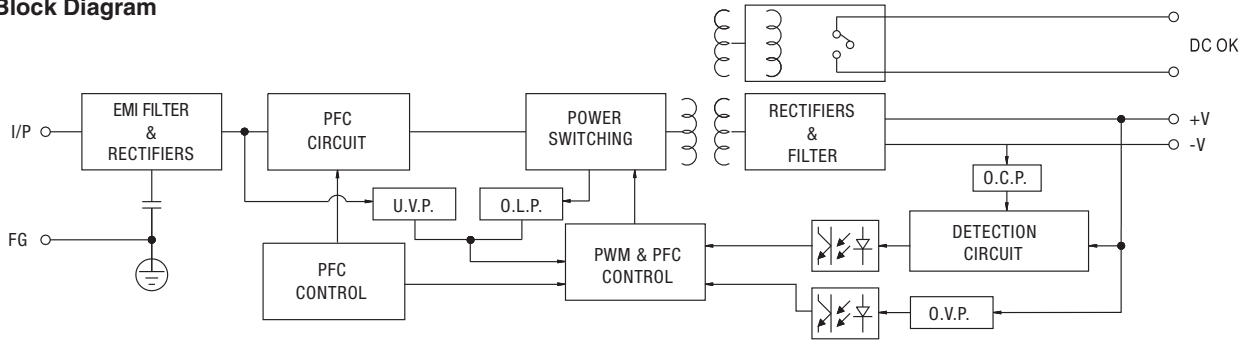

## DC OK Relay Contact

Contact Close	PSU turns on / DC OK.
Contact Open	PSU turns off / DC Fail.
Contact Ratings (max.)	30V/1A resistive load.

## Derating Curve

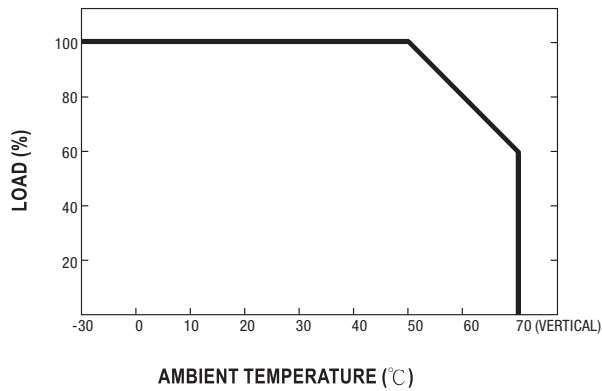

## Output Derating VS Input Voltage

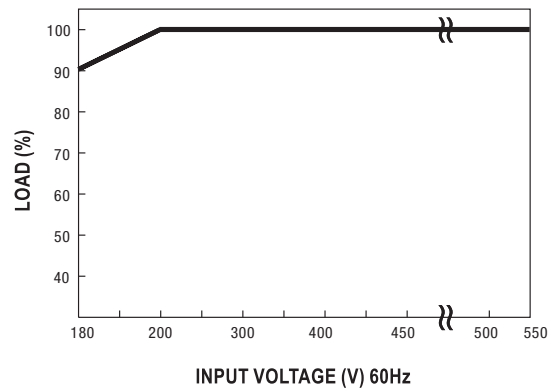

Note: All dimensions are in millimeters, to convert to inches multiply by 0.03937.



# PSW-480 Series Specifications



## Features:

- Single and two phase wide input range 180~550VAC
- High efficiency 93% and low power dissipation
- Protections: Short Circuit / Overload / Over Voltage / Overtemperature
- Cooling by free air convection
- DIN rail mountable
- UL 508(industrial control equipment) approved
- EN61000-6-2 (EN50082-2) industrial immunity level
- Built-in DC OK relay contact
- 100% full load burn-in test
- 3 year warranty

## OUTPUT

Cat. No.	PSW-48024	PSW-48048
----------	-----------	-----------

DC VOLTAGE	24V	48V
RATED CURRENT	20A	10A
CURRENT RANGE	0 ~ 20A	0 ~ 10A
RATED POWER	480W	480W
RIPPLE & NOISE (max)	100mVp-p	150mVp-p
Ripple & noise are measured at 20MHz of bandwidth by using a 12 twisted pair-wire terminated with a 0.1µF & 47µF parallel capacitor.		
VOLTAGE ADJ. RANGE	24 ~ 28V	48 ~ 55V
VOLTAGE TOLERANCE	±1.0%	±1.0%
Tolerance: includes set up tolerance, line regulation and load regulation.		
LINE REGULATION	±0.5%	±0.5%
LOAD REGULATION	±1.0%	±1.0%
SETUP, RISE, HOLD UP TIME	800ms, 150ms, 18ms / 400VAC	2000ms, 150ms, 16ms / 230VAC at full load

## INPUT

VOLTAGE RANGE	180 ~ 550VAC	254 ~ 780VDC
Derating may be needed under low input voltage. Please check the derating curve for more details		
FREQUENCY RANGE	47 ~ 63Hz	
EFFICIENCY (Typ.)	92%	93%
AC CURRENT	1.6A / 400VAC	4A / 230VAC
INRUSH CURRENT (Typ.)	COLD START 50A	
LEAKAGE CURRENT	≤ 3.5 mA / 530VAC	

## PROTECTION

OVERLOAD	105 ~ 130% rated output power	
Protection type: Constant current limiting, unit will shut down after 3 sec.; auto recovery after 1 minute if the fault condition is removed		
OVERVOLTAGE	29 ~ 33V	56 ~ 65V
Protection type: Shut down overvoltage; auto recovery after 1 minute if the fault condition is removed		
Under over-voltage condition, if input voltage ≤ 200VAC, the power supply will shut down and then may have auto-recovery after several seconds.		
OVERTEMPERATURE	95°C ± 5°C (TSW) detect on heat sink of power switch	
Protection type: Shut down overvoltage, recovers automatically after temperature goes down		
DC OK RELAY CONTACT RATINGS (max.)	60VDC / 0.3A; 30VDC / 1A; 30VAC / 0.5A resistive load	

## ENVIRONMENT

WORKING TEMP.	-30 ~ +70°C (Refer to output load derating curve)	
Installation clearances: 40mm on top, 20mm on the bottom, 5mm on the left and right side are recommended when loaded permanently with full power. In case the adjacent device is a heat source, 15mm clearance is recommended.		
WORKING HUMIDITY	20 ~ 95% RH non-condensing	
STORAGE TEMP., HUMIDITY	-40 ~ +85°C; 10 ~ 95% RH	
TEMP. COEFFICIENT	±0.03% / °C (0 ~ 50°C)	
VIBRATION	10 ~ 500Hz, 2G 10min./1cycle, 60 min. each long X,Y, Z axes	
MOUNTING	Compliance to IEC60068-2-6	

## SAFETY & EMC

SAFETY STANDARDS	UL508 approved IEC 60950-1 compliant Design refer to GL		
WITHSTAND VOLTAGE	I/P-O/P: 3KVAC	I/P-FG:1.5KVAC	O/P-FG:0.5KVAC O/P-DC OK:0.5KVAC
ISOLATION RESISTANCE	I/P-O/P, I/P-FG, O/P-FG: 100M Ohms / 500VDC (25°C; 70% RH)		
EMI CONDUCTION & RADIATION	EN55022 (CISPR22), EN61204-3 Class B		
HARMONIC CURRENT	Compliance to EN61000-3-2,-3		
EMS IMMUNITY	Compliance to EN61000-4-2,3,4,5,6,8,11; ENV50204; EN 55024; EN61000-6-2; (EN50082-2); EN61204-3; heavy industry level; criteria A approved;		
The power supply is considered a component which will installed into a final equipment. The final equipment must be re-confirmed that it still meets EMC directives.			

## OTHERS

MTBF	112.8K hrs min.	MIL-HDBK-217K (25°C)
DIMENSION	85.5x125.2x128.5mm (WxHxD)	
PACKING	1.7Kg; 8pcs / 14.6Kg / 0.9CUFT	
All parameters NOT specially mentioned are measured at 400VAC input, rated load and 25°C of ambient temperature.		



## Mechanical Specification

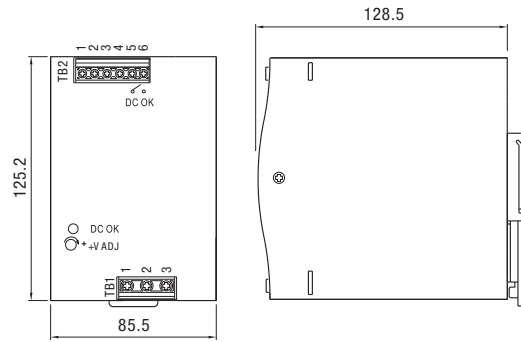

Terminal Pin No. Assignment (TB1)

Pin No.	Assignment
1	FG $\oplus$
2	AC/L2
3	AC/L1

Terminal Pin No. Assignment (TB2)

Pin No.	Assignment
1,2	DC OUTPUT +V
3,4	DC OUTPUT -V
5,6	Relay Contact

## Block Diagram

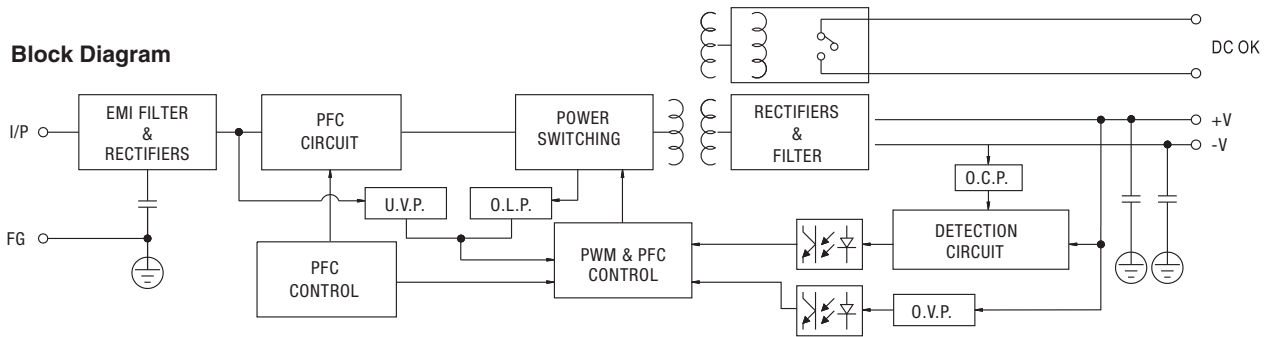

## DC OK Relay Contact

Contact Close	PSU turns on / DC OK.
Contact Open	PSU turns off / DC Fail.
Contact Ratings (max.)	30V/1A resistive load.

## Derating Curve

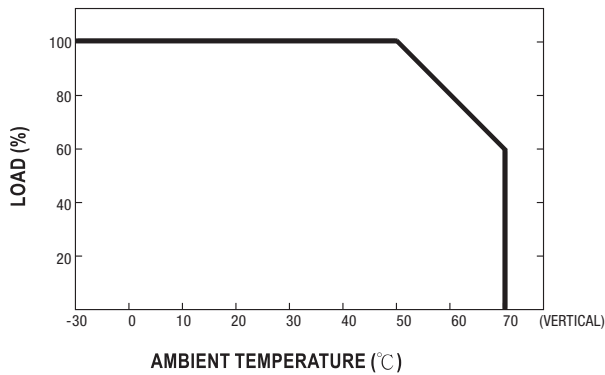

## Output Derating VS Input Voltage

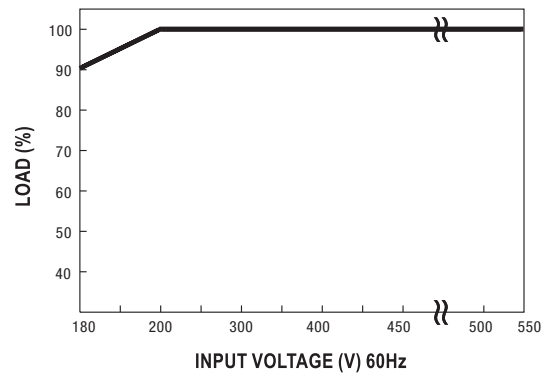

Note: All dimensions are in millimeters, to convert to inches multiply by 0.03937.



# CBI All in One DC UPS Power Solutions

## Everything and more!

- More efficiency of the battery thanks to continuous control over time.
- More monitoring in main connection nodes: input, output load, battery.
- Event logging: number of battery charging cycles, charge cycles completed, aborted charge cycles, Ah charged, charging time, total number of transitions stand-by /back-up etc.
- Event Management: checking the load output, shutdown management of PCs (UPS function), RESET management of a generic equipment.
- Flexibility of use: customization of the entire charging curve of the battery, battery type setting, setting of the various time-out algorithms of charge, setting boost voltage, absorption, float, etc... configuration as DC-UPS or batteries charger, enabling power supply function.

## Power Continuity

### DC-UPS = Power Supply + Battery Charger + Back Up Module

Double Output, Optimized Power Management. Thanks to the DC-UPS units, it will be possible to smart-manage available power. It will be automatically allocated between load and battery. Supplying power to the load is the first priority of the unit; thus it is not necessary to double the power, and also the power available for the battery will go to the load if the load requires so.

**Output Load:** 12, 24, 48  
**Power Boost:** In x 2 Continuous  
In x 3 max 4 sec.

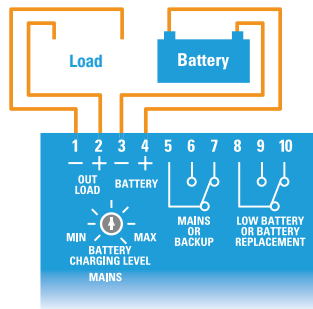

In Power Boost mode the maximum current on the load output is the 2 times the rated current ( $2 \times I_n$ ) in continuous operation and 3 times the rated current ( $3 \times I_n$ ) for max. 4 seconds.

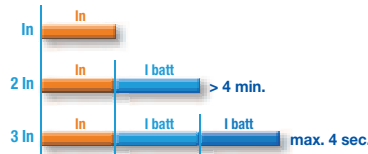

### Time Buffering

Time buffering is enabled when in back-up mode. Buffering time setting is possible by operating the rotary switch on the front panel.



### Smart Battery Management

Load output will not be affected by battery conditions. The DC-UPS insures continuous power supply to the load even in conditions of completely discharged batteries. The automatic multi-stage operation optimizes and adapts to the battery status. DC-UPS can recharge deeply discharged batteries even when their voltage is close to zero, thus allowing recharge and complete recovery of flat batteries.

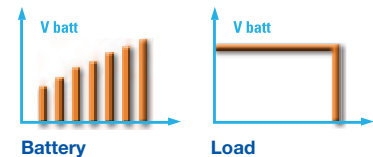

### Avoid Deep Battery Discharge

In case of mains failure, the battery will supply the load until battery voltage reaches 1.5 Vpc (Volt per cell). Below this level the device automatically switches off to prevent deep discharge and battery damage.

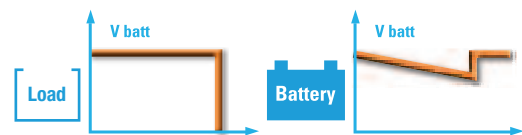

### Adjustable Maximum Battery Charging Current

The maximum battery charging current can be set from 10% to 100% of the device rated value.

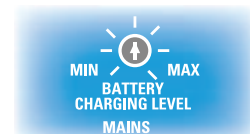

# CBI All in One DC UPS Power Solutions

## Power Continuity

### Start from Battery without Main

If you want to restart the system while the mains is off, a battery restart function is available, via RTCONN cable connections, or via pushbutton in the front panel.

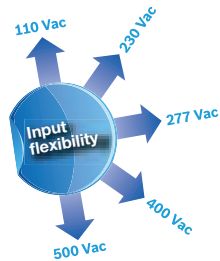
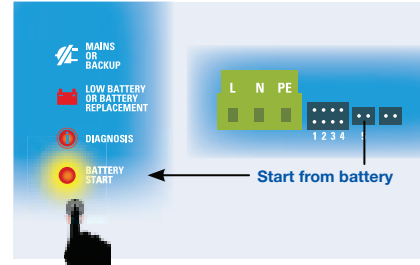

### Wide input voltage range

Flexibility is given also by the wide range input voltage. The range of the devices accept input voltage 120 - 230 - 277 - 400 - 500 VAC.

### One device for output 12 or 24 VDC

You can select the voltage between 12 or 24 VDC just before installing the device in your panel (available on selected products in the new Altech DC-UPS units).



## Connection & Monitoring

### Monitor Signals

Clear definition of each system operation, via LED indications and Relay contact:

#### Contact Port signals, galvanic insulation

- Main or back-up signaling relay with voltage-free. NO-NC output terminals.
- Battery faulty signaling relay, relay with voltage-free. NO-NC output terminals.
- Flat battery signaling relay, relay with voltage-free. NO-NC output terminals.

#### Display Signals by LED

- Input Main On Off
- Battery Fault
- Low battery (capacity less than 30%)
- Type of Battery charge mode
- Help through "blinking code" the diagnosis of the system

### Driver Contact

Remote link for selection of trickle/ boost charging Via RTCONN remote connections cable it is possible to drive the devices from Boost - Bulk to Trickle - Float charge. It is also possible to permanently install a jumper for Boost - Bulk Charging.

### Accessories

All DC-UPS units can be made available with the following options by RJ45 or RJ11 connector:

Temperature sensor Probe, for ambient temperature compensation charging.



Voltage drop cable compensation.



Battery Start UP cable.

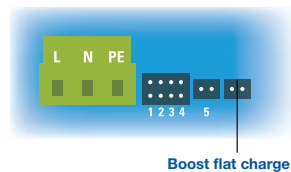
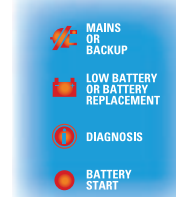
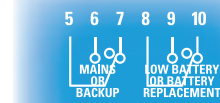

### Auxiliary output "Aux 2 and "Aux 3" MODBUS and CANBUS

MODBUS and CANBUS connection for Multimedia management, for connection to external displays and perform customized data monitoring. Connection to:

- Power View App
- Power View Graphic
- Power View System
- Power View Bar Graph
- Power Bus
- Power View Config

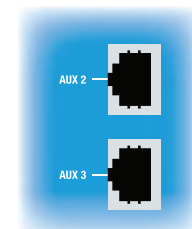

# CBI All in One DC UPS Power Solutions

These devices are completely automatic and can charge any kind of battery using factory pre-set charging curves suitable to the most common battery technologies: open lead acid, sealed lead acid, lead gel, Ni-Cd and Ni-MH. These devices are very flexible and can be customized to meet the needs of the user and the requirements of the application. After the installation, it is possible to carry out functional software updates just using any laptop computer. Doing so, your system can always be updated to changing requirements. The Battery Care concept is based on algorithms that implement rapid and automatic charging, battery charge optimization during time, flat batteries recovery and real time diagnostic during installation and operation. Battery faults such as battery sulfated, elements in short circuit, accidental reverse polarity connection can easily be detected, identified and removed. The All in one Series meet the highest standards of quality and insure high reliability, with MTBF values up to 300.000 hours.

## Battery Care

### One Device for All Battery Types

All devices are suitable to charge most batteries types thank to user selectable charging curves. They can charge open lead acid, sealed lead acid, Gel, Ni-Cd, Ni-MH, Li Ion batteries. It is possible to change or add other charging curves connecting the device to a portable PC. Charging mode is then completely automatic.

**Open Lead Acid (factory preset):**  
Trickle 2.23 V  
Boost 2.40 V

**Sealed Lead Acid (1):**  
Trickle 2.25 V  
Boost 2.40 V

**AGM Sealed Lead Acid (2):**  
Trickle 2.27 V  
Boost 2.40 V

**Gel:**  
Trickle 2.30 V  
Boost 2.40 V

Optional: Ni/Cd, LI-Ion

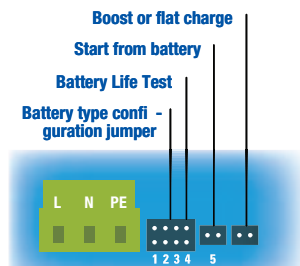

Boost or float charge.

### Multi-Stage Charging / Four Charging Modes

Automatic multi-stage operation and real time diagnostic allows fast recharge and recovery of deeply discharged batteries, adding value and reliability to the system hosting the DC-UPS device. The type of charging is Voltages stabilized and Current stabilized IUoU. CBI battery chargers feature four charging modes, identified by a flashing code on a LED.

- Recovery (5 Blinks / sec) able to recharge batteries even when their voltage is close to zero.
- Boost - Bulk (2 Blinks / sec).
- Absorption (1 Blinks / sec).
- Trickle - Float (1 Blink / 2 sec).

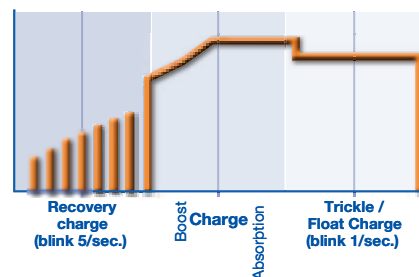

### Diagnosis of Battery and Device

All CBI devices support the user during installation and operation. A LED flashing sequence code allows to discriminate among various possible faults. Error conditions, LED Fault ON and LED Diagnosis flashing with sequence of:

- 1 flash = Reverse polarity, wrong battery voltage
- 2 flashes = Disconnected battery
- 3 flashes = Battery element in short circuit
- 4 flashes = Overload
- 5 flashes = Battery to be replaced (Internal impedance Bad or Bad battery wire connection).



# CBI All in One DC UPS Power Solutions

## Battery Care

### Battery Life Test

It guarantees battery reliability in time by continuously testing the internal impedance status. It avoids any possible risk of damages and grants also a permanent, reliable and safe connection of the battery to the power supply. The system, through a battery stimulation circuit with algorithms of evaluation of the detected parameter, is able to recognize sulfated batteries or batteries with a short-circuited cell.

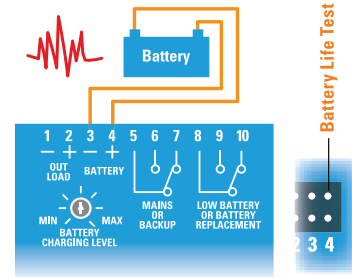

### Temperature Compensation

In special application like fire fighting equipment, you can recharge the battery also with the temperature compensation charging function, for the best condition of your battery in the temperature fluctuation. Use Port# CBI-RJTEMP for this application.

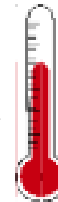

### Diagnostic Checks

#### Check for accidental disconnection of the battery cables.

DC-UPS detects accidental disconnection and immediately switches off output power.

#### Battery not connected.

If the battery is not connected the battery output is disabled.

#### Test of wire connection impedance.

During trickle charge the resistance on the battery connection is checked every 20 sec. This to detect if the cable connection has been properly made.

#### Battery in open circuit or sulfated.

Every four hours DC-UPS tests of internal impedance, while in trickle charging mode.

#### Reverse polarity check.

If the battery it is connected with inverted polarity, DC-UPS is automatically protected.

#### Test of battery voltage connections.

Appropriate voltage check, to prevent connection of wrong battery types.

#### End of charge check.

When the battery it is completely full, the device automatically switches to trickle charging mode.

#### Check for battery cells in short circuit.

Thanks to specific testing algorithms, the DC-UPS recognize batteries with cells in internal short circuit.

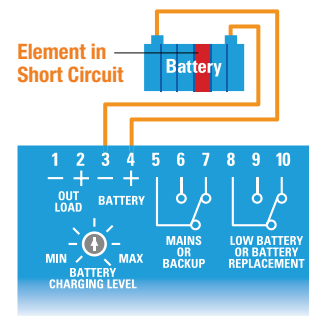

---

## Maximum Safety and Protection

The DC-UPS series is designed to provide safe operation and long power supply and battery life. The following protections are standard features:

- Outputs protected against short circuit and overload
- Outputs in conformity to SELV and PELV conditions
- High insulation between primary and secondary
- Protection against deep battery discharge
- Protection against reverse polarity connection
- Detection of batteries with wrong rated voltage

All protections have automatic reset. No thermal fuse to be replaced. Robust construction and easy installation All the units in the range have aluminum casing, DIN rail fastening clip and are light and compact. IP20 protection degree.

### Technology

The new DC-UPS range is based on two strategic know-how elements. Switching technology, we have 25 years of experience in design of advanced stabilized switching technology power supplies. A power supply/battery charger unit based on this technology is much more efficient.

Back UP Module and Battery Care units, unlike most other state-of-the-art battery chargers, the DC-UPS series is equipped with complex algorithms which controls the charging process and enable several monitoring functions. The firmware implements the extended battery care know-how, result of many years of experience in this field.

### Standards:

- IEC/EN 60335-2-29 Battery chargers
- EN60950 / UL60950
- EMC Directive
- Electrical safety EN54-4 Fire Detection and fire alarm systems
- DIN 41773 (Charging cycle)



# CBI All in One DC UPS Power Solutions

CBI All In One UPS Power Solutions combine the requirements for several applications in just one device which can be used as power supply unit, battery charger, battery care module or backup module. The available power is automatically distributed among load and battery, while supplying power to the load always is the first priority. The maximum available current of the load output is two times the value of the device's rated current.

If the device is disconnected from the main power source, the battery will supply the load until the battery voltage reaches 1.5 V per cell. This prevents the battery from deep discharge. CBI devices provide microprocessor controlled battery charging. Using algorithms, the battery's condition will be detected and based on that, an appropriate charging mode is chosen. The real-time diagnostics system will continuously monitor the charging progress and indicate possibly occurring faults such as elements in short circuit, accidental reverse polarity connection or disconnection of the battery by the battery fault LED and a flashing code of the diagnosis LED.

CBI All In One UPS Power Solutions are suitable for open/sealed lead acid-, lead gel- and optionally Ni-Cd batteries. By using the battery-select-jumper, it is possible to set predefined charging curves for those battery types. The available charging options are recovery-, boost- and trickle charge. All CB devices are built in a rugged metal case with a DIN rail mounting bracket.

## Features:

- Power supply, battery charger, battery care module and backup module in one device
- Three charging modes
- Compact, rugged metal case
- Available in 12VDC, 24VDC and 48VDC
- Suitable for most common battery types
- Adjustable charging current
- Easy battery diagnosis and fault identification either by LED or external devices connected to fault
- Status contacts
- High efficiency up to 91% through switching technology
- Several output protection features such as short circuit, overload, deep battery discharge etc.
- DIN rail mounting
- Small size
- 3 year warranty

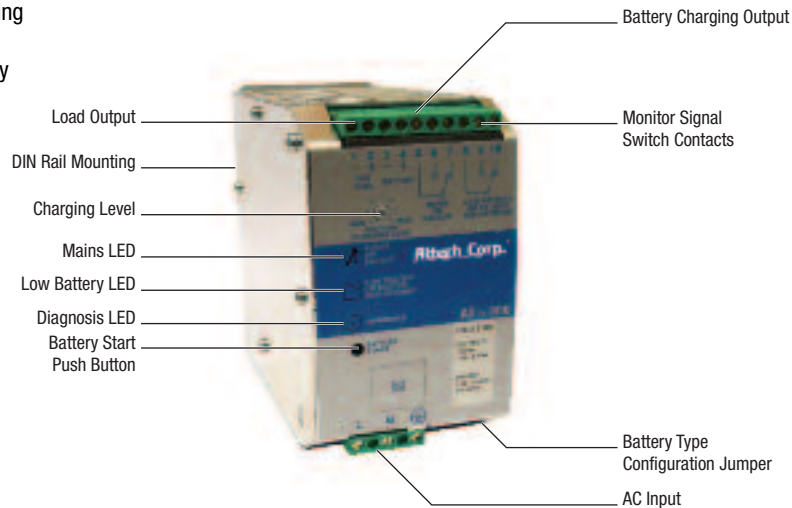

## Battery Selection Chart

Battery type	1.2 Ah	3.2 Ah	7.2 Ah	12 Ah
Load 1.5 A	20	60	200	400
Load 3 A	8	30	120	240
Load 5 A	3	15	55	100
Load 7.5 A	2	10	30	60
Load 10 A	-	7	20	45
Load 12 A	-	3	12	30
Load 15 A	-	-	9	20
Load 20 A	-	-	7	13

BUFFERING  
(MINUTE) TIME



# CBI All in One DC UPS Power Solutions

The new communication platform for ALTECH CORP. devices allows the connection of all components in a simple but very powerful way. A single communication protocol based on MODbus-RTU or CANbus technology. You can select any of the two buses depending on the application. It allows to communicate with all the accessories provided by ALTECH CORP. and to develop an independent system for electrical continuity. At the same time, it allows monitoring and control all parameters in the system, even from the other side of the world, by means of application tools on the cloud.

ALTECH CORP. allows you to implement very simple but sophisticated monitoring and control for your energy system and opens your mind to new ways to approach your applications.

## 1 Power View App

System Monitoring Software APP for Tablet "Power View App", is an application for tablet, available in free download. With this App it is possible to connect to ALTECH CORP. cloud and visualize in real time data stored in your own account on the cloud. Data upload is possible through "Power Bus", an ALTECH CORP. MODBUS/Ethernet interface which connects the DC-UPS MODBUS output to the cloud. Uploaded data can be battery voltage, charge current, discharge current, level of charge, charging mode, alarms, diagnostic signals and more. This allows monitoring of DC-UPS and battery status from any location. It just requires wireless internet connection via tablet.

## 2 Power View System

Monitoring Software

"Power View System" is a PC-based software developed to monitor in real time every important parameter of the DCUPS/battery system. A simple and intuitive user's interface allows monitoring of battery parameters, load output, temperature sensor, mains presence and all alarm and diagnostic flags. All feature are displayed in a single screen.

## 3 Power View Graphic

Multifunction Graphic Display

"Power View Graphic" is a Multifunction Graphic Display that can be connected by a single data/power cables to the MODBUS interface of a DC-UPS. It allows to display all parameters of the DC-UPS/battery system that can be accessed by moving through the various screens with a push button user's interface. The screen is back-lit and features a screen saver function for energy saving and longer life.

## 4 Power View Bar Graph

"Power View Bar Graph" is a circular LED display device for panel mount. Simple and sturdy, it displays the current charge mode, state of charge and system diagnostics at a glance.

## 5 Power Bus

Interface Module MODBUS 485 - Ethernet and Cloud ALTECH CORP. provides a set of educated MODBUS interfaces that allow remote access to DC-UPS/battery data. Both Ethernet and Cloud communication is therefore made feasible.

## 6 Power Storage Devices

No matter how large or small the capacity of the battery storage needed in the system, ALTECH CORP. DC-UPS devices allow simple and effective integration. ALTECH CORP. has been a pioneer in the development of automatic charging and monitoring DC-UPS. Thanks to Adel Battery Care technology every battery will be taken care of and will last longer. Continuous system monitoring and life test checking allows preventive replacement and therefore increased system reliability. For a compact and optimized integration, ALTECH CORP. supplies Batt VRLA battery modules.

## 7 Temperature Compensated Charging

By installing the battery temperature probe "RJ Temp", the charge voltage is automatically adapted to battery temperatures. When the battery temperature is low, the charge voltage increases. Conversely, when battery temperature is high, charge voltage is decreased. Over charge and gassing are thus prevented. This will extend battery life, the specific goal of Adel Battery Care philosophy.

## 8 Load

The DC-UPS unit mission is to always keep the load supplied. The Load Output is the source of power for the whole electric system and has been designed to perform this duty under the most critical conditions, no matter if during stand-by or back-up modes.

## 9 Inverter

Among the loads there are sometime devices which requires AC power. In this case an inverter must be installed. ALTECH CORP. DC-UPSs allow connection of inverters up to 1500W.

## 10 Power View Config

System Configuration Software "Power View Config" is a PC-based software with simple and effective user interface that allows application engineer to configure the system, customize battery charging curve, set alarm thresholds, configure the parameters available for communication on the MODBUS output. Output Voltage: 12, 24, 48 Vdc.

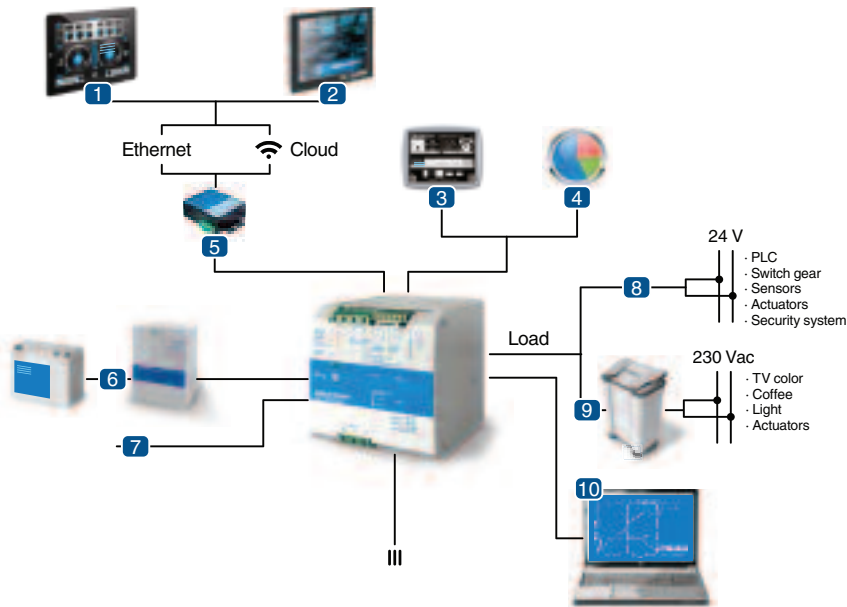



# CBI All In One UPS Power Solutions Specifications



## Features:

- Power supply, battery charger, battery care module and backup module in one device
- Three charging modes
- Several output protection modes
- Compact, rugged metal case
- Available in 12VDC, 24VDC and 48VDC
- Suitable for most common battery types
- Three charging modes
- Adjustable charging current
- High efficiency up to 91% through switching technology
- DIN rail mounting
- Small size
- 3 year warranty

## \* Case Sizes

- Size 1:** 65 mm x 115 mm x 135 mm  
**Size 2:** 100 mm x 115 mm x 135 mm  
**Size 3:** 150 mm x 115 mm x 135 mm

## 12V DC Single Phase DIN Rail All In One UPS Power Solution

Case 1



Cat. No.	Case*	Input VAC	Output*		Recovery Charge VDC	Trickle Charge VDC	Boost Charge VDC	NOTES
			VDC	A				
CBI123A	1	115-230-277	12	3	2-9	13.75	14.4	
CBI126A	1	115-230-277	12	6	2-9	13.75	14.4	
CBI1210A	1	115-230-277	12	10	2-9	13.75	14.4	
CBI1235A	3	115-230-277	12	35	2-9	13.75	14.4	

## 24V DC Single Phase DIN Rail All In One UPS Power Solution

Case 2



Cat. No.	Case*	Input VAC	Output*		Recovery Charge VDC	Trickle Charge VDC	Boost Charge VDC	NOTES
			VDC	A				
CBI243A	1	115-230-277	24	3	2-16	27.5	28.8	
CBI245A	1	115-230-277	24	5	2-18	27.5	28.8	
CBI2410A	2	115-230-277	24	10	2-16	27.5	28.8	
CBI2420A	3	115-230-277	24	20	2-16	27.5	28.8	

## 48V DC Single Phase DIN Rail All-In-One UPS Power Solution

Case 3



Cat. No.	Case*	Input VAC	Output*		Recovery Charge VDC	Trickle Charge VDC	Boost Charge VDC	NOTES
			VDC	A				
CBI485A	2	115-230-277	48	5	2-24	55	57.6	
CBI4810A	3	115-230-277	48	10	2-24	55	57.6	

## Multi-Voltage DIN Rail All-In-One UPS Power Solution

Cat. No.	Case*	Input VAC	Output*		Recovery Charge VDC	Trickle Charge VDC	Boost Charge VDC	NOTES
			VDC	A				
CBI280 3648A	2	115-230-277	36/ 48	7/ 5	2-24	41/ 55	43.2/ 57.6	
CBI280 1224A	2	115-230-277	12/ 24	15/ 10	2-18	13.75/ 27.5	14.4/ 28.8	
CBI280 1224B	2	230-400-500	12/ 24	15/ 10	2-16	13.75/ 27.5	14.4/ 28.8	

\*= Output Current can be adjusted from 20%-100% of value given above

# SPECIFICATIONS

## Case 1

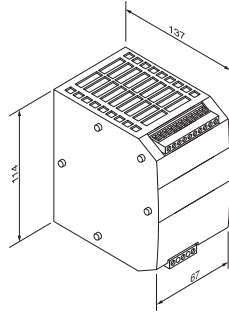

**Input Voltage:** 115 - 230 - 277 VAC  
**Input Current:** 2.8-1.3A (115-230VAC)  
**Connection:** screw terminal blocks for wires 0.2-2.5mm<sup>2</sup> / AWG 24-14  
**Size (WxHxD):** 65x115x135 mm  
**Packaging:** 0.6kg

### Jumper for Battery Type Selection

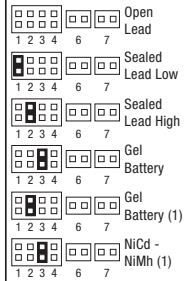

### Jumper for Functional Setting

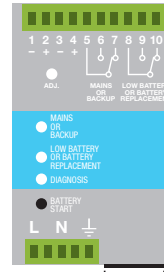
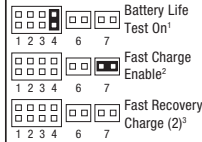

## Case 2

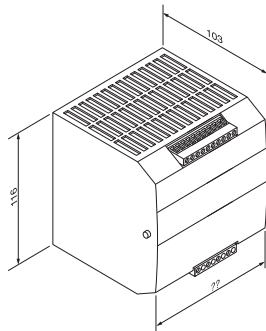

**Input Voltage:** 115 / 230 - 277 VAC  
**Input Current:** 3.3-2.2A (115-230VAC)  
**Connection:** screw terminal blocks for wires 0.2-2.5mm<sup>2</sup> / AWG 24-14  
**Size (WxHxD):** 100x115x135 mm  
**Packaging:** 0.85kg

### Jumper for Battery Type Selection

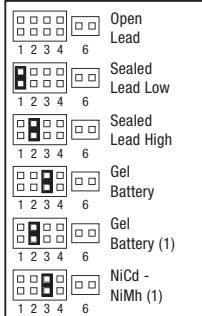

### Jumper for Functional Setting

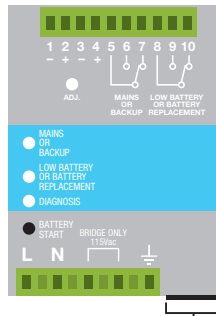
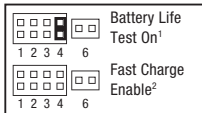

## Case 3

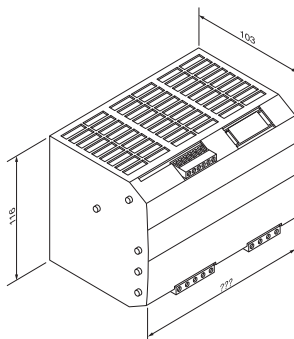

**Input Voltage:** 115 / 230 - 277 VAC  
**Input Current:** 8-4.2A (115-230VAC)  
**Connection:** screw terminal blocks for wires 4mm<sup>2</sup> / AWG 30-10  
**Size (WxHxD):** 150x115x135 mm  
**Packaging:** 1.55kg

### Jumper for Battery Type Selection

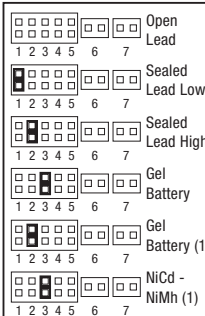

### Jumper for Functional Setting

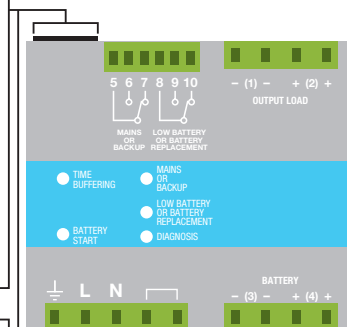
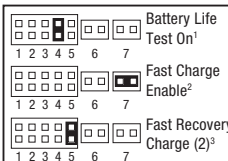



# CBI123A DC UPS



## Features:

- Input: Single-phase 115 - 277 VAC
- Output Load: power supply 12 VDC; 3 A
- Output: Battery charging 12 VDC; 3 A
- Suited for the following battery types:  
Open Lead Acid, Sealed Lead Acid, lead Gel and Ni-Cd (option)
- Automatic diagnostic of battery status.
- Switching technology, output voltage 10-14.4 VDC
- Three charging levels: Boost, trickle and recovery
- Protection degree IP20 - DIN rail mountable

	Cat. No.	CBI123A
<b>INPUT</b>	Nominal Input Voltage Voltage range Inrush Current ( $V_n - I_n$ nom. Load). $I^2t$ Frequency Input Current (115 – 230 VAC) Internal fuse (factory replaceable) External Fuse (recommended) MCB curve B	115 ~ 230 ~ 277 VAC 90 – 305 VAC $\leq 11 A \leq 5 \text{ msec}$ 47 – 63 Hz 2.8 ~ 1.3 A 4 A 10 A
<b>OUTPUT</b>	Output Voltage ( $V_n$ ) / Nominal Current ( $I_n$ ) Output Current $I_n$ Efficiency (at 50% of rated current) Turn-On delay after applying input voltage Start up with Strong Load (capacitive load) Dissipation power load max	12 VDC / 3A 3 A $\geq 90 \%$ 1 sec. (max) Yes, Unlimited 9 W
<b>PROTECTION</b>	Short-circuit protection Over Load protection Over Voltage Output protection Over Temperature protection	Yes Yes Yes (typ. 35 VDC) Yes
<b>LOAD OUTPUT</b>	Output voltage (at $I_n$ ) Nominal current $I_{load}$ Continuous current (without battery) $I_{load} = I_n$ Continuous current (with battery) $I_{load} = I_n + I_{batt}$ Max. Current Output Load (Main) $I_{load}$ (4 sec.) Max. Current Output Load (Back Up) $I_{load}$ (4 sec.) Push Button or Remote Input Control (RTCONN cable) Time Buffering; min (switch output off without main input) Protection alarm against total discharge Threshold alarm for battery almost flat	10 ~ 14.4 VDC $1.1 \times I_n A \pm 5\%$ 3 A 6 A 9 A max. 6 A max. Start From Battery Without Main $\infty$ : standard 5 min.: Require SW 9-10V DC battery 10-11 V DC battery
<b>BATTERY OUTPUT</b>	Boost charge (25 °C) (at $I_n$ ) Max. time Bust Charge Min. time Bust Charge Trickle charge (25 °C) (at $I_n$ ) Jumper Configuration battery type (V cell) Ni-Cd (optional) Recovery Charge Charging current max $I_{batt}$ Charging current limiting $I_{adj}$ Reverse battery protection Sulfated battery check Detection of element in short circuit Quiescent Current Charging Curve automatic: $I_{UoUo}$ Remote Input Control (RTCONN cable)	14.4 VDC 15 h 1 min. 13.75 VDC 2.23; 2.25; 2.27; 2.30; NiCd: 1.50 (10 elem.) 2 ~ 9 VDC 3 A $\pm 5\%$ 20 – 100 % / $I_{batt}$ Yes Yes by Jumper Yes $\leq 5 \text{ mA}$ 3 stage Boost /Trickle / Recovery
<b>OTHERS</b>	Ambient temperature (operation) De Rating $T_a > 50^\circ\text{C}$ Ambient temperature Storage Humidity at 25 °C no condensation Cooling MTBF	-25 – +70°C - 2.5%( $I_n$ ) / °C -40 – +85°C 95% Auto convection > 300.000 h (IEC 61709)

# CBI123A DC UPS

The Altech DC-UPS system is built to optimize power management. The available power is automatically allocated between load and battery, supplying power to the load is the first priority. For high inrush applications the charging power will reroute automatically to the load. In this case the maximum available current on the load output is two times the value of the device rated current.

The Battery Care concept based on algorithms that achieve rapid and automatic charging, battery optimization during charging time, flat batteries recovery and real time diagnostic The Real Time Auto-diagnostic system, monitors battery faults, sulfated battery, short circuit battery elements, reverse polarity connection, battery disconnect. This conditions are detected and identified by the number of blinks of the diagnosis Led.

## Signal Output Contacts

Main or Backup Power	Yes
Battery Power Low	Yes
Battery Fault	Yes
Max. Current Rating (Resistive Load)	1A 30 VDC/60 VAC
Minimum Permissible Current Rating	1mA @ 5 VDC

## RJ45 Connection Input / Output

Temp. Comp. Battery (with ext. probe)	Yes - Optional
Remote monitoring display	Yes - Optional
Can Bus	No

## Environment

Insulation voltage (IN/OUT)	3000 VAC
Insulation voltage (input / ground)	1605 VAC
Insulation voltage (Output / ground)	500 VAC
Protection Class (EN/IEC 60529)	IP20
Pollution Degree Environment	2
Connection TB, Screw Terminal	2,5 mm <sup>2</sup> (24-14AWG)
Protection class (Ground Connected)	Class I
Dimensions (WxHxD)	65x115x135 mm
2.56x4.53x5.32 in	
Weight (approx.)	0.6 kg (1.35 Lbs)

## Safety and EMC

Battery charger standard compliance	IEC/EN 60335-2-29
Safety standards compliance:	EN60950 / UL1950 / CE
Fire Detection and alarm compliance	EN54-4
EMC Directive	89/336/EEC
Charging cycle	DIN41773
Emission	IEC 61000-6-4
Immunity	IEC 61000-6-2

The Altech DC-UPS system is designed to charge and monitor all battery types, by selecting the battery type via jumpers. The predefined curves include Open Lead Acid, Sealed Lead Acid, Gel, Ni-Cd (optional) battery types. The charging curve are programmed to automatically switch between Recovery Charge, Boost charge and Trickle charge. The continuous battery efficiency monitoring, reduces battery damage risk and allows a safe operation in permanent connection.

A compact and rugged metal case with DIN rail mounting bracket provide an easy installation and an IP20 protection.

## Jumper for Battery Type Selection

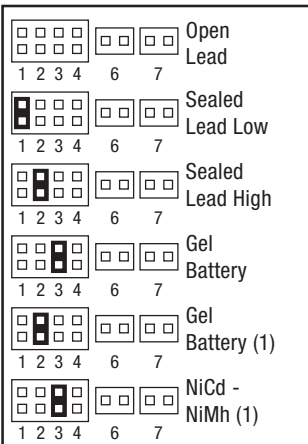

## Jumper for Functional Setting

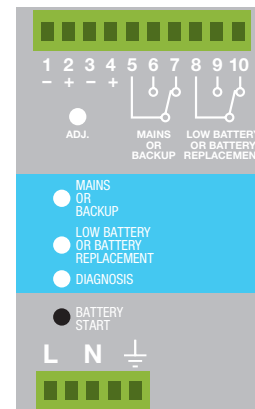
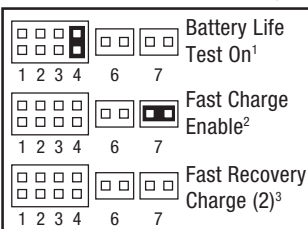

- 1 Jumper present: life test enabled.
- 2 Jumper present: fast test enabled.
- 3 Jumper present: fast recovery charge enabled only for size 3. Possibility to recharge the battery also when the voltage is close to zero with the maximum power of the device.

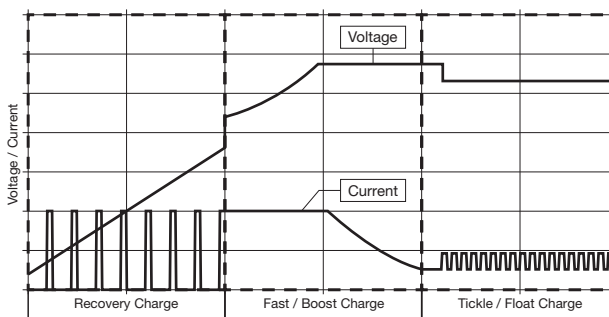
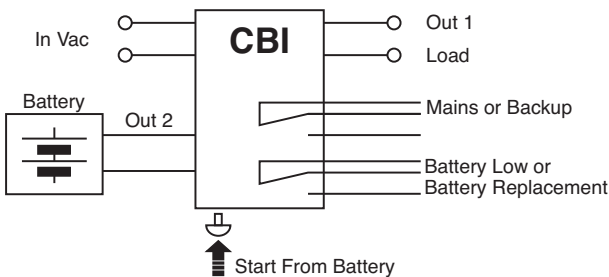



# CBI126A DC UPS



## Features:

- Input: Single-phase 115 - 277 VAC
- Output Load: power supply 12 VDC; 6 A
- Output: Battery charging 12 VDC; 6 A
- Suited for the following battery types:  
Open Lead Acid, Sealed Lead Acid, lead Gel and Ni-Cd (option)
- Automatic diagnostic of battery status.
- Switching technology, output voltage 10-14.4 VDC
- Three charging levels: Boost, trickle and recovery
- Protection degree IP20 - DIN rail mountable

	Cat. No.	CBI126A
<b>INPUT</b>	Nominal Input Voltage Voltage range Inrush Current ( $V_n - I_n$ nom. Load). I <sup>2</sup> t Frequency Input Current (115 – 230 VAC) Internal fuse (factory replaceable) External Fuse (recommended) MCB curve B	115 ~ 230 ~ 277 VAC 90 – 305 VAC ≤11 A ≤ 5 msec 47 – 63 Hz 2.8 ~ 1.3 A 4 A 10 A
<b>OUTPUT</b>	Output Voltage ( $V_n$ ) / Nominal Current ( $I_n$ ) Output Current $I_n$ Efficiency (at 50% of rated current) Turn-On delay after applying input voltage Start up with Strong Load (capacitive load) Dissipation power load max	12 VDC / 6A 6 A ≥ 90 % 1 sec. (max) Yes, Unlimited 17 W
<b>PROTECTION</b>	Short-circuit protection Over Load protection Over Voltage Output protection Over Temperature protection	Yes Yes Yes (typ. 35 VDC) Yes
<b>LOAD OUTPUT</b>	Output voltage (at $I_n$ ) Nominal current $I_{load}$ Continuous current (without battery) $I_{load} = I_n$ Continuous current (with battery) $I_{load} = I_n + I_{batt}$ Max. Current Output Load (Main) $I_{load}$ (4 sec.) Max. Current Output Load (Back Up) $I_{load}$ (4 sec.) Push Button or Remote Input Control (RTCONN cable) Time Buffering; min (switch output off without main input) Protection alarm against total discharge Threshold alarm for battery almost flat	10 ~ 14.4 VDC 1.1 x $I_n A \pm 5\%$ 6 A 12 A 18 A max. 12 A max. Start From Battery Without Main ∞: standard 5 min.: Require SW 9-10 VDC battery voltage 10-11 VDC battery voltage
<b>BATTERY OUTPUT</b>	Boost charge (25 °C) (at $I_n$ ) Max. time Bust Charge Min. time Bust Charge Trickle charge (25 °C) (at $I_n$ ) Jumper Configuration battery type (V cell) Ni-Cd (optional) Recovery Charge Charging current max $I_{batt}$ Charging current limiting $I_{adj}$ Reverse battery protection Sulfated battery check Detection of element in short circuit Quiescent Current Charging Curve automatic: $I_{UoUo}$ Remote Input Control (RTCONN cable)	14.4 VDC 15 h 1 min. 13.75 VDC 2.23; 2.25; 2.27; 2.30; NiCd: 1.50 (10 elem.) 2 ~ 9 VDC 6 A ± 5% 20 – 100 % / $I_{batt}$ Yes Yes by Jumper Yes ≤ 5 mA 3 stage Boost /Trickle / Recovery
<b>OTHERS</b>	Ambient temperature (operation) De Rating $T_a > 50^\circ C$ Ambient temperature Storage Humidity at 25°C no condensation Cooling MTBF (IEC 61709)	-25 – +70°C - 2.5%( $I_n$ ) / °C -40 – +85°C 95% Auto convection > 300.000 h

# CBI126A

## DC UPS

The Altech DC-UPS system is built to optimize power management. The available power is automatically allocated between load and battery, supplying power to the load is the first priority. For high inrush applications the charging power will reroute automatically to the load. In this case the maximum available current on the load output is two times the value of the device rated current.

The Battery Care concept based on algorithms that achieve rapid and automatic charging, battery optimization during charging time, flat batteries recovery and real time diagnostic. The Real Time Auto-diagnostic system, monitors battery faults, sulfated battery, short circuit battery elements, reverse polarity connection, battery disconnect. This conditions are detected and identified by the number of blinks of the diagnosis Led.

### Signal Output Contacts

Main or Backup Power	Yes
Battery Power Low	Yes
Battery Fault	Yes
Max. Current Rating (Resistive Load)	1A 30 VDC/60 VAC
Minimum Permissible Current Rating	1mA @ 5 VDC

### RJ45 Connection Input/Output

Temp. Comp. Battery (with ext. probe)	Yes - Optional
Remote monitoring display	Yes - Optional
Can Bus	No

### Environment

Insulation voltage (IN/OUT)	3000 VAC
Insulation voltage (input / ground)	1605 VAC
Insulation voltage (Output / ground)	500 VAC
Protection Class (EN/IEC 60529)	IP20
Pollution Degree Environment	2
Connection TB, Screw Terminal	2,5 mm <sup>2</sup> (24-14AWG)
Protection class (Ground Connected)	Class I
Dimensions (WxHxD)	65x115x135 mm
2.56x4.53x5.32 in	
Weight (approx.)	0.6 kg (1.35 Lbs)

### Safety and EMC

Battery charger standard compliance	IEC/EN 60335-2-29
Safety standards compliance:	EN60950 / UL1950 / CE
Fire Detection and alarm compliance	EN54-4
EMC Directive	89/336/EEC
Charging cycle	DIN41773
Emission	IEC 61000-6-4
Immunity	IEC 61000-6-2

The Altech DC-UPS system is designed to charge and monitor all battery types, by selecting the battery type via jumpers. The predefined curves include Open Lead Acid, Sealed Lead Acid, Gel, Ni-Cd (optional) battery types. The charging curve are programmed to automatically switch between Recovery Charge, Boost charge and Trickle charge. The continuous battery efficiency monitoring, reduces battery damage risk and allows a safe operation in permanent connection.

A compact and rugged metal case with DIN rail mounting bracket provide an easy installation and an IP20 protection.

### Jumper for Battery Type Selection

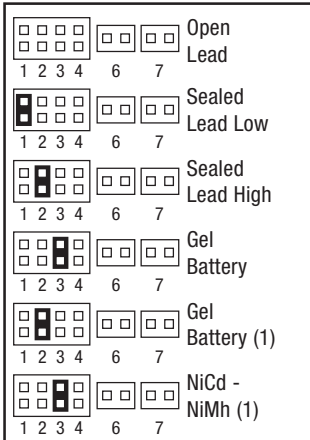

### Jumper for Functional Setting

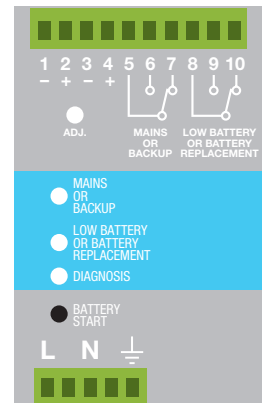
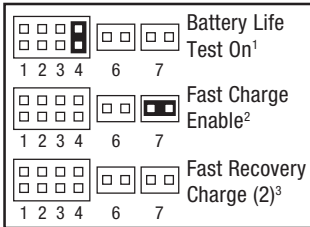

- <sup>1</sup> Jumper present: life test enabled.
- <sup>2</sup> Jumper present: fast test enabled.
- <sup>3</sup> Jumper present: fast recovery charge enabled only for size 3. Possibility to recharge the battery also when the voltage is close to zero with the maximum power of the device.

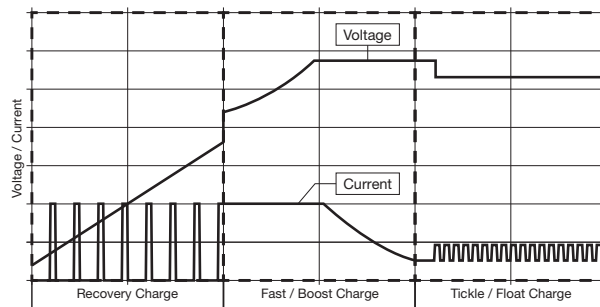
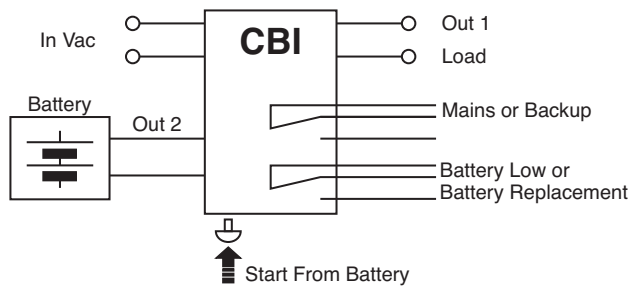





# CBI1210A DC UPS



## Features:

- Input: Single-phase 115 - 277 VAC
- Output Load: power supply 12 VDC; 10 A
- Output: Battery charging 12 VDC; 10 A
- Suited for the following battery types:  
Open Lead Acid, Sealed Lead Acid, lead Gel and Ni-Cd (option)
- Automatic diagnostic of battery status.
- Switching technology, output voltage 10-14.4 VDC
- Three charging levels: Boost, trickle and recovery
- Protection degree IP20 - DIN rail mountable

	Cat. No.	CBI1210A
<b>INPUT</b>	Nominal Input Voltage Voltage range Inrush Current ( $V_n - I_n$ nom. Load). $I^2t$ Frequency Input Current (115 – 230 VAC) Internal fuse (factory replaceable) External Fuse (recommended) MCB curve B	115 ~ 230 ~ 277 VAC 90 – 305 VAC $\leq 11 \text{ A} \leq 5 \text{ msec}$ 47 – 63 Hz 2.8 ~ 1.3 A 4 A 10 A
<b>OUTPUT</b>	Output Voltage ( $V_n$ ) / Nominal Current ( $I_n$ ) Output Current $I_n$ Efficiency (at 50% of rated current) Turn-On delay after applying input voltage Start up with Strong Load (capacitive load) Dissipation power load max	12 VDC / 10A 10 A $\geq 90 \%$ 1 sec. (max) Yes, Unlimited 17 W
<b>PROTECTION</b>	Short-circuit protection Over Load protection Over Voltage Output protection Over Temperature protection	Yes Yes Yes (typ. 35 VDC) Yes
<b>LOAD OUTPUT</b>	Output voltage (at $I_n$ ) Nominal current $I_{load}$ Continuous current (without battery) $I_{load} = I_n$ Continuous current (with battery) $I_{load} = I_n + I_{batt}$ Max. Current Output Load (Main) $I_{load}$ (4 sec.) Max. Current Output Load (Back Up) $I_{load}$ (4 sec.) Push Button or Remote Input Control (RTCONN cable) Time Buffering; min (switch output off without main input) Protection alarm against total discharge Threshold alarm for battery almost flat	10 ~ 14.4 VDC $1.1 \times I_n \pm 5\%$ 10 A 20 A 30 A max. 20 A max. Start From Battery Without Main $\infty$ : standard 5 min.: Require SW 9-10V DC battery 10-11 V DC battery
<b>BATTERY OUTPUT</b>	Boost charge (25 °C) (at $I_n$ ) Max. time Bust Charge Min. time Bust Charge Trickle charge (25 °C) (at $I_n$ ) Jumper Configuration battery type (V cell) Ni-Cd (optional) Recovery Charge Charging current max $I_{batt}$ Charging current limiting $I_{adj}$ Reverse battery protection Sulfated battery check Detection of element in short circuit Quiescent Current Charging Curve automatic: $I_{UoUo}$ Remote Input Control (RTCONN cable)	14.4 VDC 15 h 1 min. 13.75 VDC 2.23; 2.25; 2.27; 2.30; NiCd: 1.50 (10 elem.) 2 ~ 9 VDC 10 A $\pm 5\%$ 20 – 100 % / $I_{batt}$ Yes Yes by Jumper Yes $\leq 5 \text{ mA}$ 3 stage Boost /Trickle / Recovery
<b>OTHERS</b>	Ambient temperature (operation) De Rating $T_a > 50^\circ\text{C}$ Ambient temperature Storage Humidity at 25°C no condensation Cooling MTBF	-25 – +70°C - 2.5%( $I_n$ ) / °C -40 – +85°C 95% Auto convection > 300.000 h (IEC 61709)



# CBI1210A

## DC UPS

The Altech DC-UPS system is built to optimize power management. The available power is automatically allocated between load and battery, supplying power to the load is the first priority. For high inrush applications the charging power will reroute automatically to the load. In this case the maximum available current on the load output is two times the value of the device rated current.

The Battery Care concept based on algorithms that achieve rapid and automatic charging, battery optimization during charging time, flat batteries recovery and real time diagnostic The Real Time Auto-diagnostic system, monitors battery faults, sulfated battery, short circuit battery elements, reverse polarity connection, battery disconnect. This conditions are detected and identified by the number of blinks of the diagnosis Led.

### Signal Output Contacts

Main or Backup Power	Yes
Battery Power Low	Yes
Battery Fault	Yes
Max. Current Rating (Resistive Load)	1A 30 VDC/60 VAC
Minimum Permissible Current Rating	1mA @ 5 VDC

### RJ45 Connection Input/Output

Temp. Comp. Battery (with ext. probe)	Yes - Optional
Remote monitoring display	Yes - Optional
Can Bus	No

### Environment

Insulation voltage (IN/OUT)	3000 VAC
Insulation voltage (input / ground)	1605 VAC
Insulation voltage (Output / ground)	500 VAC
Protection Class (EN/IEC 60529)	IP20
Pollution Degree Environment	2
Connection TB, Screw Terminal	2,5 mm <sup>2</sup> (24-14AWG)
Protection class (Ground Connected)	Class I
Dimensions (WxHxD)	65x115x135 mm
2.56x4.53x5.32 in	
Weight (approx.)	0.6 kg (1.35 Lbs)

### Safety and EMC

Battery charger standard compliance	IEC/EN 60335-2-29
Safety standards compliance:	EN60950 / UL1950 / CE
Fire Detection and alarm compliance	EN54-4
EMC Directive	89/336/EEC
Charging cycle	DIN41773
Emission	IEC 61000-6-4
Immunity	IEC 61000-6-2

The Altech DC-UPS system is designed to charge and monitor all battery types, by selecting the battery type via jumpers. The predefined curves include Open Lead Acid, Sealed Lead Acid, Gel, Ni-Cd (optional) battery types. The charging curve are programmed to automatically switch between Recovery Charge, Boost charge and Trickle charge. The continuous battery efficiency monitoring, reduces battery damage risk and allows a safe operation in permanent connection.

A compact and rugged metal case with DIN rail mounting bracket provide an easy installation and an IP20 protection.

### Jumper for Battery Type Selection

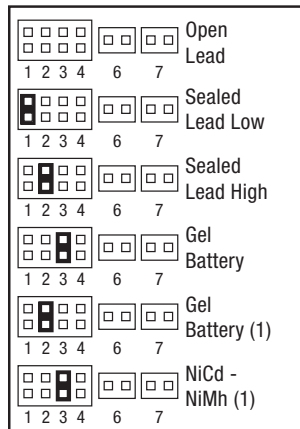

### Jumper for Functional Setting

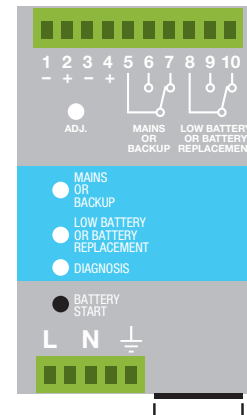
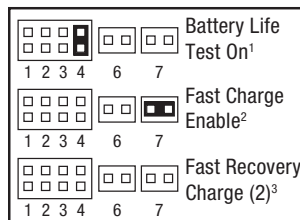

- 1 Jumper present: life test enabled.
- 2 Jumper present: fast test enabled.
- 3 Jumper present: fast recovery charge enabled only for size 3. Possibility to recharge the battery also when the voltage is close to zero with the maximum power of the device.

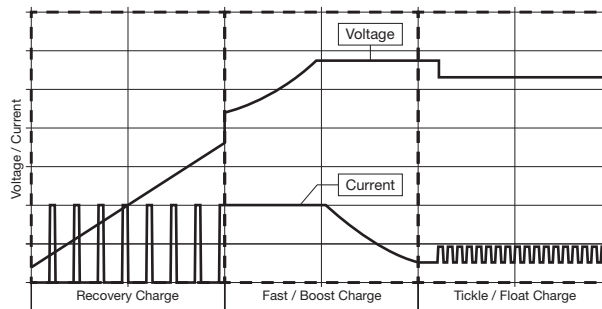
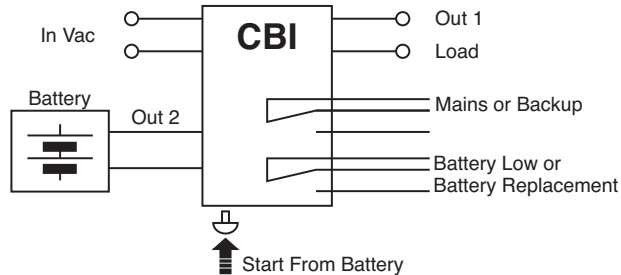



# CBI1235A DC UPS



## Features:

- Input: Single-phase 115 - 277 VAC
- Output Load: power supply 12 VDC; 35 A
- Output: Battery charging 12 VDC; 35 A
- Suited for the following battery types:  
Open Lead Acid, Sealed Lead Acid, lead Gel and Ni-Cd (option)
- Automatic diagnostic of battery status.
- Switching technology, output voltage 10-14.4 VDC
- Three charging levels: Boost, trickle and recovery
- Protection degree IP20 - DIN rail mountable

	Cat. No.	CBI1235A
<b>INPUT</b>	Nominal Input Voltage Voltage range Inrush Current ( $V_n - I_n$ nom. Load). I <sup>2</sup> t Frequency Input Current (115 – 230 VAC) Internal fuse (factory replaceable) External Fuse (recommended) MCB curve B	115 / 230 ~ 277 VAC 90 – 135 / 180-305 VAC $\leq 35 \text{ A} \leq 5 \text{ msec}$ 47 – 63 Hz 8 ~ 4.2 A 10 A 16 A
<b>OUTPUT</b>	Output Voltage ( $V_n$ ) / Nominal Current ( $I_n$ ) Output Current $I_n$ Efficiency (at 50% of rated current) Turn-On delay after applying input voltage Start up with Strong Load (capacitive load) Dissipation power load max	12 VDC / 35A 35 A $\geq 91 \%$ 1 sec. (max) Yes, Unlimited 48 W
<b>PROTECTION</b>	Short-circuit protection Over Load protection Over Voltage Output protection Over Temperature protection	Yes Yes Yes (typ. 35 VDC) Yes
<b>LOAD OUTPUT</b>	Output voltage (at $I_n$ ) Nominal current $I_{load}$ Continuous current (without battery) $I_{load} = I_n$ Continuous current (with battery) $I_{load} = I_n + I_{batt}$ Max. Current Output Load (Main) $I_{load}$ (4 sec.) Max. Current Output Load (Back Up) $I_{load}$ (4 sec.) Push Button or Remote Input Control (RTCONN cable) Time Buffering; min (switch output off without main input) Protection alarm against total discharge Threshold alarm for battery almost flat	10 ~ 14.4 VDC $1.1 \times I_n \pm 5\%$ 35 A 70 A 105 A max. 70 A max. Start From Battery Without Main 0.5, 1, 3, 5, 10, 15, 20, 30, 45, 60, $\infty$ ; Require SW 9-10V DC battery 10-11 V DC battery
<b>BATTERY OUTPUT</b>	Boost charge (25 °C) (at $I_n$ ) Max. time Bust Charge Min. time Bust Charge Trickle charge (25 °C) (at $I_n$ ) Jumper Configuration battery type (V cell) Ni-Cd (optional) Recovery Charge Charging current max $I_{batt}$ Charging current limiting $I_{adj}$ Reverse battery protection Sulfated battery check Detection of element in short circuit Quiescent Current Charging Curve automatic: $I_{UoUo}$ Remote Input Control (RTCONN cable)	14.4 VDC 15 h 1 min. 13.75 VDC 2.23; 2.25; 2.27; 2.30; NiCd: 1.50 (10 elem.) 2 ~ 9 VDC 35 A $\pm 5\%$ 20 – 100 % / $I_{batt}$ Yes Yes by Jumper Yes $\leq 5 \text{ mA}$ 3 stage Boost /Trickle / Recovery
<b>OTHERS</b>	Ambient temperature (operation) De Rating $T_a > 50^\circ\text{C}$ Ambient temperature Storage Humidity at 25°C no condensation Cooling MTBF (IEC 61709)	-25 – +70°C - 2.5%( $I_n$ ) / °C -40 – +85°C 95% Auto convection > 300.000 h

# CBI1235A

## DC UPS

The Altech DC-UPS system is built to optimize power management. The available power is automatically allocated between load and battery, supplying power to the load is the first priority. For high inrush applications the charging power will reroute automatically to the load. In this case the maximum available current on the load output is two times the value of the device rated current.

The Battery Care concept based on algorithms that achieve rapid and automatic charging, battery optimization during charging time, flat batteries recovery and real time diagnostic. The Real Time Auto-diagnostic system, monitors battery faults, sulfated battery, short circuit battery elements, reverse polarity connection, battery disconnect. This conditions are detected and identified by the number of blinks of the diagnosis Led.

### Signal Output Contacts

Main or Backup Power	Yes
Battery Power Low	Yes
Battery Fault	Yes
Max. Current Rating (Resistive Load)	1A 30 VDC/60 VAC
Minimum Permissible Current Rating	1mA @ 5 VDC

### RJ45 Connection Input/Output

Temp. Comp. Battery (with ext. probe)	Yes - Optional
Remote monitoring display	Yes - Optional
Can Bus	Yes - Optional

### Environment

Insulation voltage (IN/OUT)	3000 VAC
Insulation voltage (input / ground)	1605 VAC
Insulation voltage (Output / ground)	500 VAC
Protection Class (EN/IEC 60529)	IP20
Pollution Degree Environment	2
Connection TB, Screw Terminal	4 mm <sup>2</sup> (30–10AWG)
Protection class (Ground Connected)	Class I
Dimensions (WxHxD)	150x115x135 mm
5.91x4.53x5.32 in	
Weight (approx.)	1.55 kg (3.5 Lbs)

### Safety and EMC

Battery charger standard compliance	IEC/EN 60335-2-29
Safety standards compliance:	EN60950 / UL1950 / CE
Fire Detection and alarm compliance	EN54-4
EMC Directive	89/336/EEC
Charging cycle	DIN41773
Emission	IEC 61000-6-4
Immunity	IEC 61000-6-2

The Altech DC-UPS system is designed to charge and monitor all battery types, by selecting the battery type via jumpers. The predefined curves include Open Lead Acid, Sealed Lead Acid, Gel, Ni-Cd (optional) battery types. The charging curve are programmed to automatically switch between Recovery Charge, Boost charge and Trickle charge. The continuous battery efficiency monitoring, reduces battery damage risk and allows a safe operation in permanent connection.

A compact and rugged metal case with DIN rail mounting bracket provide an easy installation and an IP20 protection.

### Jumper for Battery Type Selection

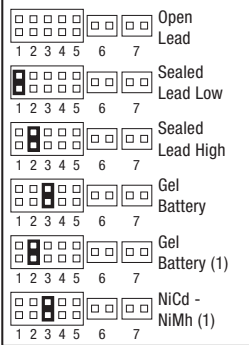

### Jumper for Functional Setting

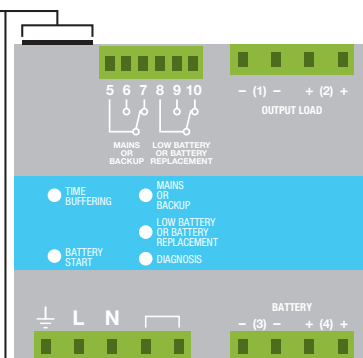
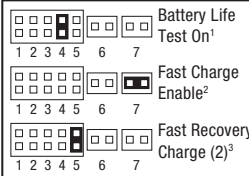

- 1 Jumper present: life test enabled.
- 2 Jumper present: fast test enabled.
- 3 Jumper present: fast recovery charge enabled only for size 3. Possibility to recharge the battery also when the voltage is close to zero with the maximum power of the device.

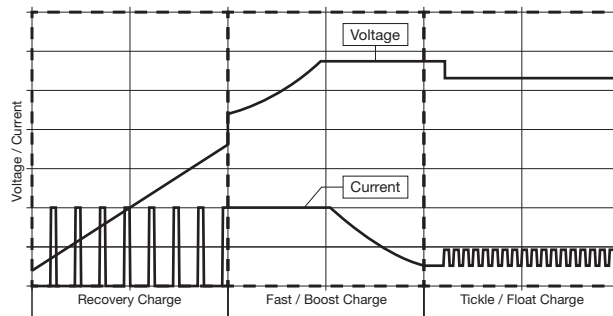
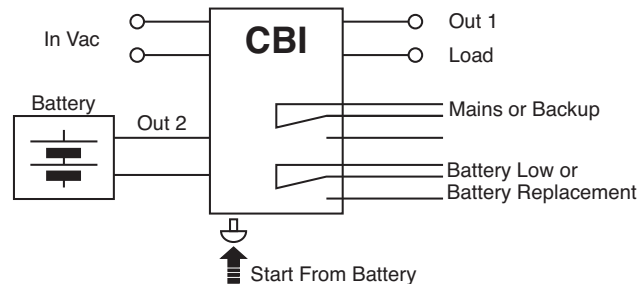



# CBI243A DC UPS



## Features:

- Input: Single-phase 115 - 277 VAC
- Output Load: power supply 24 VDC; 3 A
- Output: Battery charging 24 VDC; 3 A
- Suited for the following battery types:  
Open Lead Acid, Sealed Lead Acid, lead Gel and Ni-Cd (option)
- Automatic diagnostic of battery status.
- Switching technology, output voltage 22-28.8 VDC
- Three charging levels: Boost, trickle and recovery
- Protection degree IP20 - DIN rail mountable

## INPUT

## OUTPUT

## PROTECTION

## LOAD OUTPUT

## BATTERY OUTPUT

## OTHERS

### Cat. No.

### CBI243A

Nominal Input Voltage Voltage range Inrush Current ( $V_n - I_n$ nom. Load). I <sup>2</sup> t Frequency Input Current (115 – 230 VAC) Internal fuse (factory replaceable) External Fuse (recommended) MCB curve B	115 ~ 230 ~ 277 VAC 90 – 305 VAC ≤11 A ≤ 5 msec 47 – 63 Hz 2.8 ~ 1.3 A 4 A 10 A
Output Voltage ( $V_n$ ) / Nominal Current ( $I_n$ ) Output Current $I_n$ Efficiency (at 50% of rated current) Turn-On delay after applying input voltage Start up with Strong Load (capacitive load) Dissipation power load max	24 VDC / 3A 3 A ≥ 90 % 1 sec. (max) Yes, Unlimited 13 W
Short-circuit protection Over Load protection Over Voltage Output protection Over Temperature protection	Yes Yes Yes (typ. 35 VDC) Yes
Output voltage (at $I_n$ ) Nominal current $I_{load}$ Continuous current (without battery) $I_{load} = I_n$ Continuous current (with battery) $I_{load} = I_n + I_{batt}$ Max. Current Output Load (Main) $I_{load}$ (4 sec.) Max. Current Output Load (Back Up) $I_{load}$ (4 sec.) Push Button or Remote Input Control (RTCONN cable) Time Buffering; min (switch output off without main input) Protection alarm against total discharge Threshold alarm for battery almost flat	22 ~ 28.8 VDC 1.1 x $I_n$ A ± 5% 3 A 6 A 9 A max. 6 A max. Start From Battery Without Main ∞: standard 5 min.: Require SW 19-20V DC battery 20-21 V DC battery
Boost charge (25 °C) (at $I_n$ ) Max. time Bust Charge Min. time Bust Charge Trickle charge (25 °C) (at $I_n$ ) Jumper Configuration battery type (V cell) Ni-Cd (optional) Recovery Charge Charging current max $I_{batt}$ Charging current limiting $I_{adj}$ Reverse battery protection Sulfated battery check Detection of element in short circuit Quiescent Current Charging Curve automatic: $I_{UoUo}$ Remote Input Control (RTCONN cable)	28.8 VDC 15 h 1 min. 27.5 VDC 2.23; 2.25; 2.27; 2.30; NiCd: 1.50 (20 elem.) 2 ~ 16 VDC 3 A ± 5% 20 – 100 % / $I_{batt}$ Yes Yes by Jumper Yes ≤ 5 mA 3 stage Boost /Trickle / Recovery
Ambient temperature (operation) De Rating $T_a > 50^\circ\text{C}$ Ambient temperature Storage Humidity at 25°C no condensation Cooling MTBF (IEC 61709)	-25 – +70°C - 2.5%( $I_n$ ) / °C -40 – +85°C 95% Auto convection > 300.000 h

# CBI243A

## DC UPS

The Altech DC-UPS system is built to optimize power management. The available power is automatically allocated between load and battery, supplying power to the load is the first priority. For high inrush applications the charging power will reroute automatically to the load. In this case the maximum available current on the load output is two times the value of the device rated current.

The Battery Care concept based on algorithms that achieve rapid and automatic charging, battery optimization during charging time, flat batteries recovery and real time diagnostic. The Real Time Auto-diagnostic system, monitors battery faults, sulfated battery, short circuit battery elements, reverse polarity connection, battery disconnect. This conditions are detected and identified by the number of blinks of the diagnosis Led.

### Signal Output Contacts

Main or Backup Power	Yes
Battery Power Low	Yes
Battery Fault	Yes
Max. Current Rating (Resistive Load)	1A 30 VDC/60 VAC
Minimum Permissible Current Rating	1mA @ 5 VDC

### RJ45 Connection Input/Output

Temp. Comp. Battery (with ext. probe)	Yes - Optional
Remote monitoring display	Yes - Optional
Can Bus	No

### Environment

Insulation voltage (IN/OUT)	3000 VAC
Insulation voltage (input / ground)	1605 VAC
Insulation voltage (Output / ground)	500 VAC
Protection Class (EN/IEC 60529)	IP20
Pollution Degree Environment	2
Connection TB, Screw Terminal	2,5 mm <sup>2</sup> (24-14AWG)
Protection class (Ground Connected)	Class I
Dimensions (WxHxD)	65x115x135 mm
2.56x4.53x5.32 in	
Weight (approx.)	0.6 kg (1.35 Lbs)

### Safety and EMC

Battery charger standard compliance	IEC/EN 60335-2-29
Safety standards compliance:	EN60950 / UL1950 / CE
Fire Detection and alarm compliance	EN54-4
EMC Directive	89/336/EEC
Charging cycle	DIN41773
Emission	IEC 61000-6-4
Immunity	IEC 61000-6-2

The Altech DC-UPS system is designed to charge and monitor all battery types, by selecting the battery type via jumpers. The predefined curves include Open Lead Acid, Sealed Lead Acid, Gel, Ni-Cd (optional) battery types. The charging curve are programmed to automatically switch between Recovery Charge, Boost charge and Trickle charge. The continuous battery efficiency monitoring, reduces battery damage risk and allows a safe operation in permanent connection.

A compact and rugged metal case with DIN rail mounting bracket provide an easy installation and an IP20 protection.

### Jumper for Battery Type Selection

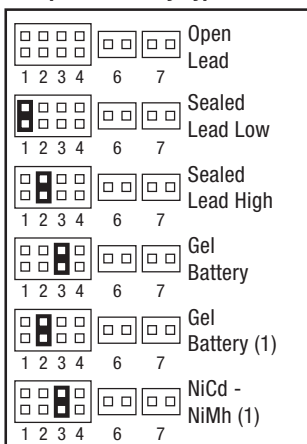

### Jumper for Functional Setting

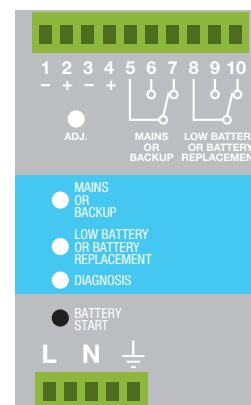
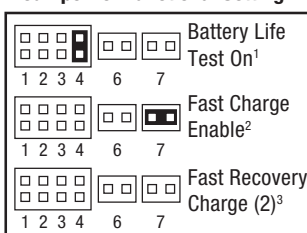

- 1 Jumper present: life test enabled.
- 2 Jumper present: fast test enabled.
- 3 Jumper present: fast recovery charge enabled only for size 3. Possibility to recharge the battery also when the voltage is close to zero with the maximum power of the device.

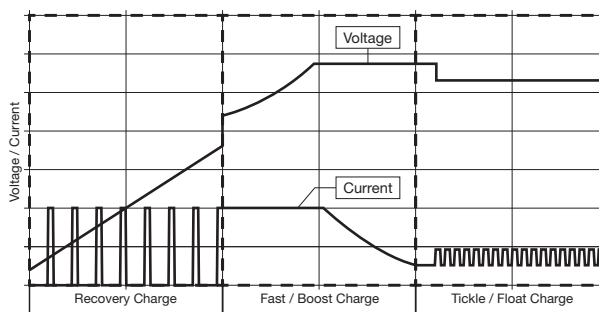
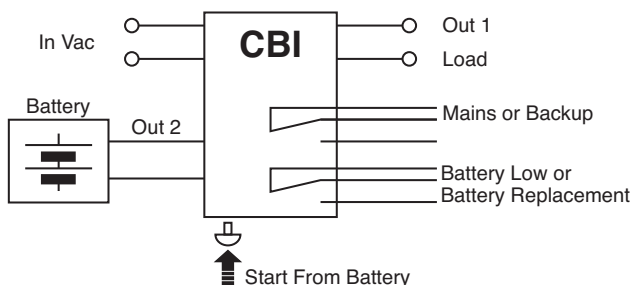



# CBI245A DC UPS



## Features:

- Input: Single-phase 115 - 277 VAC
- Output Load: power supply 24 VDC; 5 A
- Output: Battery charging 24 VDC; 5 A
- Suited for the following battery types:  
Open Lead Acid, Sealed Lead Acid, lead Gel and Ni-Cd (option)
- Automatic diagnostic of battery status.
- Switching technology, output voltage 22-28.8 VDC
- Three charging levels: Boost, trickle and recovery
- Protection degree IP20 - DIN rail mountable

	Cat. No.	CBI245A
<b>INPUT</b>	Nominal Input Voltage Voltage range Inrush Current ( $V_n - I_n$ nom. Load). $I^2t$ Frequency Input Current (115 – 230 VAC) Internal fuse (factory replaceable) External Fuse (recommended) MCB curve B	115 ~ 230 ~ 277 VAC 90 – 305 VAC $\leq 11 \text{ A} \leq 5 \text{ msec}$ 47 – 63 Hz 2.8 ~ 1.3 A 4 A 10 A
<b>OUTPUT</b>	Output Voltage ( $V_n$ ) / Nominal Current ( $I_n$ ) Output Current $I_n$ Efficiency (at 50% of rated current) Turn-On delay after applying input voltage Start up with Strong Load (capacitive load) Dissipation power load max	24 VDC / 5A 5 A $\geq 90 \%$ 1 sec. (max) Yes, Unlimited 17 W
<b>PROTECTION</b>	Short-circuit protection Over Load protection Over Voltage Output protection Over Temperature protection	Yes Yes Yes (typ. 35 VDC) Yes
<b>LOAD OUTPUT</b>	Output voltage (at $I_n$ ) Nominal current $I_{load}$ Continuous current (without battery) $I_{load} = I_n$ Continuous current (with battery) $I_{load} = I_n + I_{batt}$ Max. Current Output Load (Main) $I_{load}$ (4 sec.) Max. Current Output Load (Back Up) $I_{load}$ (4 sec.) Push Button or Remote Input Control (RTCONN cable) Time Buffering; min (switch output off without main input) Protection alarm against total discharge Threshold alarm for battery almost flat	22 ~ 28.8 VDC $1.1 \times I_n \pm 5\%$ 5 A 10 A 15 A max. 10 A max. Start From Battery Without Main $\infty$ : standard 5 min.: Require SW 19-20V DC battery 20-21 V DC battery
<b>BATTERY OUTPUT</b>	Boost charge (25 °C) (at $I_n$ ) Max. time Bust Charge Min. time Bust Charge Trickle charge (25 °C) (at $I_n$ ) Jumper Configuration battery type (V cell) Ni-Cd (optional) Recovery Charge Charging current max $I_{batt}$ Charging current limiting $I_{adj}$ Reverse battery protection Sulfated battery check Detection of element in short circuit Quiescent Current Charging Curve automatic: $I_{UoUo}$ Remote Input Control (RTCONN cable)	28.8 VDC 15 h 1 min. 27.5 VDC 2.23; 2.25; 2.27; 2.30; NiCd: 1.50 (20 elem.) 2 ~ 16 VDC 5 A $\pm 5\%$ 20 – 100 % / $I_{batt}$ Yes Yes by Jumper Yes $\leq 5 \text{ mA}$ 3 stage Boost /Trickle / Recovery
<b>OTHERS</b>	Ambient temperature (operation) De Rating $T_a > 50^\circ\text{C}$ Ambient temperature Storage Humidity at 25°C no condensation Cooling MTBF (IEC 61709)	-25 – +70°C - 2.5%( $I_n$ ) / °C -40 – +85°C 95% Auto convection > 300.000 h



# CBI245A

## DC UPS

The Altech DC-UPS system is built to optimize power management. The available power is automatically allocated between load and battery, supplying power to the load is the first priority. For high inrush applications the charging power will reroute automatically to the load. In this case the maximum available current on the load output is two times the value of the device rated current.

The Battery Care concept based on algorithms that achieve rapid and automatic charging, battery optimization during charging time, flat batteries recovery and real time diagnostic. The Real Time Auto-diagnostic system, monitors battery faults, sulfated battery, short circuit battery elements, reverse polarity connection, battery disconnect. This conditions are detected and identified by the number of blinks of the diagnosis Led.

### Signal Output Contacts

Main or Backup Power	Yes
Battery Power Low	Yes
Battery Fault	Yes
Max. Current Rating (Resistive Load)	1A 30 VDC/60 VAC
Minimum Permissible Current Rating	1mA @ 5 VDC

### RJ45 Connection Input/Output

Temp. Comp. Battery (with ext. probe)	Yes - Optional
Remote monitoring display	Yes - Optional
Can Bus	No

### Environment

Insulation voltage (IN/OUT)	3000 VAC
Insulation voltage (input / ground)	1605 VAC
Insulation voltage (Output / ground)	500 VAC
Protection Class (EN/IEC 60529)	IP20
Pollution Degree Environment	2
Connection TB, Screw Terminal	2,5 mm <sup>2</sup> (24-14AWG)
Protection class (Ground Connected)	Class I
Dimensions (WxHxD)	65x115x135 mm
2.56x4.53x5.32 in	
Weight (approx.)	0.6 kg (1.35 Lbs)

### Safety and EMC

Battery charger standard compliance	IEC/EN 60335-2-29
Safety standards compliance:	EN60950 / UL1950 / CE
Fire Detection and alarm compliance	EN54-4
EMC Directive	89/336/EEC
Charging cycle	DIN41773
Emission	IEC 61000-6-4
Immunity	IEC 61000-6-2

The Altech DC-UPS system is designed to charge and monitor all battery types, by selecting the battery type via jumpers. The predefined curves include Open Lead Acid, Sealed Lead Acid, Gel, Ni-Cd (optional) battery types. The charging curve are programmed to automatically switch between Recovery Charge, Boost charge and Trickle charge. The continuous battery efficiency monitoring, reduces battery damage risk and allows a safe operation in permanent connection.

A compact and rugged metal case with DIN rail mounting bracket provide an easy installation and an IP20 protection.

### Jumper for Battery Type Selection

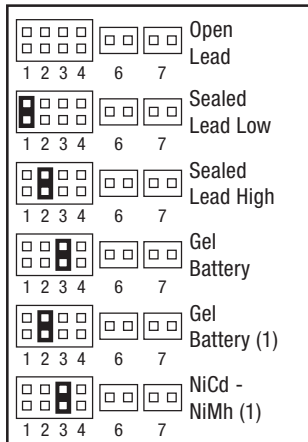

### Jumper for Functional Setting

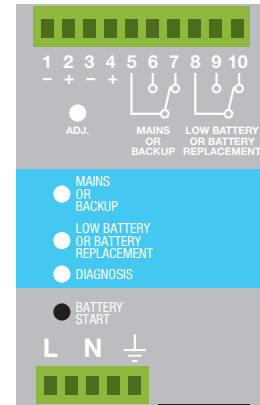
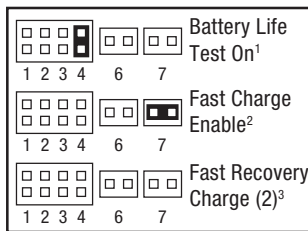

- 1 Jumper present: life test enabled.
- 2 Jumper present: fast test enabled.
- 3 Jumper present: fast recovery charge enabled only for size 3. Possibility to recharge the battery also when the voltage is close to zero with the maximum power of the device.

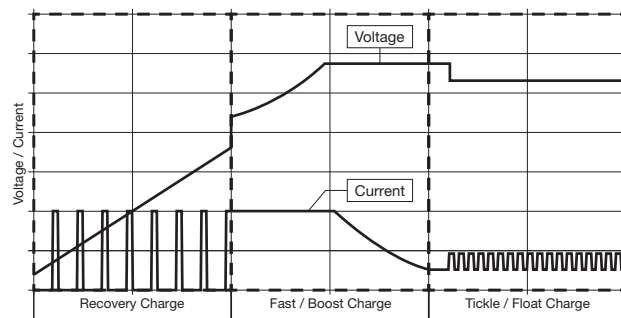
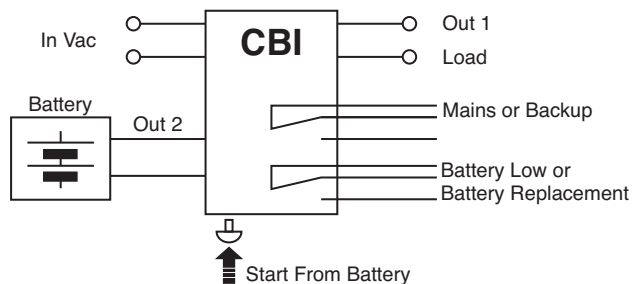





# CBI2410A DC UPS



## Features:

- Input: Single-phase 115 - 277 VAC
- Output Load: power supply 24 VDC; 10 A
- Output: Battery charging 24 VDC; 10 A
- Suited for the following battery types:  
Open Lead Acid, Sealed Lead Acid, lead Gel and Ni-Cd (option)
- Automatic diagnostic of battery status.
- Switching technology, output voltage 22-28.8 VDC
- Three charging levels: Boost, trickle and recovery
- Protection degree IP20 - DIN rail mountable

## INPUT

### Cat. No.

### CBI2410A

Nominal Input Voltage	115 / 230 ~ 277 VAC
Voltage range	90-135 / 180-305 VAC
Inrush Current ( $V_n - I_n$ nom. Load). I <sup>2</sup> t	≤16 A ≤ 5 msec
Frequency	47 – 63 Hz
Input Current (115 – 230 VAC)	3.3 ~ 2.2 A
Internal fuse (factory replaceable)	6.3 A
External Fuse (recommended) MCB curve B	16 A

## OUTPUT

Output Voltage ( $V_n$ ) / Nominal Current ( $I_n$ )	24 VDC / 10A
Output Current $I_n$	10 A
Efficiency (at 50% of rated current)	≥ 83 %
Turn-On delay after applying input voltage	1.5 sec. (max)
Start up with Strong Load (capacitive load)	Yes, Unlimited
Dissipation power load max	28 W

## PROTECTION

Short-circuit protection	Yes
Over Load protection	Yes
Over Voltage Output protection	Yes (typ. 35 VDC)
Over Temperature protection	Yes

## LOAD OUTPUT

Output voltage (at $I_n$ )	22 ~ 28.8 VDC
Nominal current $I_{load}$	1.1 x $I_n$ A ± 5%
Continuous current (without battery) $I_{load= I_n}$	10 A
Continuous current (with battery) $I_{load= I_n+ I_{batt}}$	20 A
Max. Current Output Load (Main) $I_{load}$ (4 sec.)	30 A max.
Max. Current Output Load (Back Up) $I_{load}$ (4 sec.)	20 A max.
Push Button or Remote Input Control (RTCONN cable)	Start From Battery Without Main
Time Buffering; min (switch output off without main input)	∞: standard 5 min.: Require SW
Protection alarm against total discharge	19-20V DC battery
Threshold alarm for battery almost flat	20-21 V DC battery

## BATTERY OUTPUT

Boost charge (25 °C) (at $I_n$ )	28.8 VDC
Max. time Bust Charge	15 h
Min. time Bust Charge	1 min.
Trickle charge (25 °C) (at $I_n$ )	27.5 VDC
Jumper Configuration battery type (V cell) Ni-Cd (optional)	2.23; 2.25; 2.27; 2.30; NiCd: 1.50 (20 elem.)
Recovery Charge	2 ~ 16 VDC
Charging current max $I_{batt}$	10 A ± 5%
Charging current limiting $I_{adj}$	20 – 100 % / $I_{batt}$
Reverse battery protection	Yes
Sulfated battery check	Yes by Jumper
Detection of element in short circuit	Yes
Quiescent Current	≤ 5 mA
Charging Curve automatic: $I_{UoUo}$	3 stage
Remote Input Control (RTCONN cable)	Boost /Trickle / Recovery

## OTHERS

Ambient temperature (operation)	-25 – +70°C
De Rating $T_a > 50°C$	- 2.5%( $I_n$ ) / °C
Ambient temperature Storage	-40 – +85°C
Humidity at 25°C no condensation	95%
Cooling	Auto convection
MTBF (IEC 61709)	> 300.000 h

# CBI2410A

## DC UPS

The Altech DC-UPS system is built to optimize power management. The available power is automatically allocated between load and battery, supplying power to the load is the first priority. For high inrush applications the charging power will reroute automatically to the load. In this case the maximum available current on the load output is two times the value of the device rated current.

The Battery Care concept based on algorithms that achieve rapid and automatic charging, battery optimization during charging time, flat batteries recovery and real time diagnostic. The Real Time Auto-diagnostic system, monitors battery faults, sulfated battery, short circuit battery elements, reverse polarity connection, battery disconnect. This conditions are detected and identified by the number of blinks of the diagnosis Led.

### Signal Output Contacts

Main or Backup Power	Yes
Battery Power Low	Yes
Battery Fault	Yes
Max. Current Rating (Resistive Load)	1A 30 VDC/60 VAC
Minimum Permissible Current Rating	1mA @ 5 VDC

### RJ45 Connection Input/Output

Temp. Comp. Battery (with ext. probe)	Yes - Optional
Remote monitoring display	Yes - Optional
Can Bus	No

### Environment

Insulation voltage (IN/OUT)	3000 VAC
Insulation voltage (input / ground)	1605 VAC
Insulation voltage (Output / ground)	500 VAC
Protection Class (EN/IEC 60529)	IP20
Pollution Degree Environment	2
Connection TB, Screw Terminal	2,5 mm <sup>2</sup> (24-14AWG)
Protection class (Ground Connected)	Class I
Dimensions (WxHxD)	100x115x135 mm
2.95x4.53x5.32 in	
Weight (approx.)	0.85 kg (1.9 Lbs)

### Safety and EMC

Battery charger standard compliance	IEC/EN 60335-2-29
Safety standards compliance:	EN60950 / UL1950 / CE
Fire Detection and alarm compliance	EN54-4
EMC Directive	89/336/EEC
Charging cycle	DIN41773
Emission	IEC 61000-6-4
Immunity	IEC 61000-6-2

The Altech DC-UPS system is designed to charge and monitor all battery types, by selecting the battery type via jumpers. The predefined curves include Open Lead Acid, Sealed Lead Acid, Gel, Ni-Cd (optional) battery types. The charging curve are programmed to automatically switch between Recovery Charge, Boost charge and Trickle charge. The continuous battery efficiency monitoring, reduces battery damage risk and allows a safe operation in permanent connection.

A compact and rugged metal case with DIN rail mounting bracket provide an easy installation and an IP20 protection.

### Jumper for Battery Type Selection

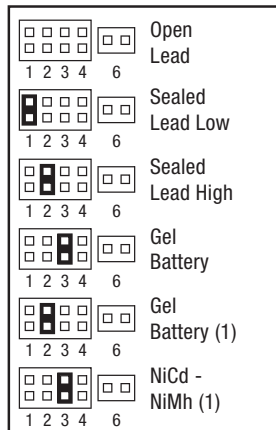

### Jumper for Functional Setting

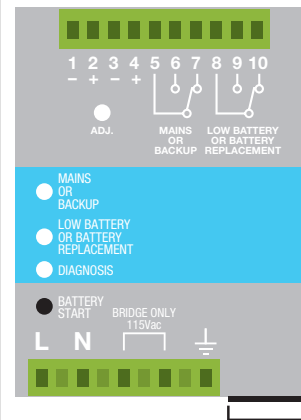
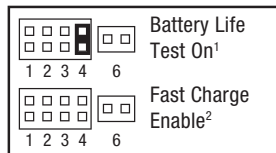

- 1 Jumper present: life test enabled.
- 2 Jumper present: fast test enabled.
- 3 Jumper present: fast recovery charge enabled only for size 3. Possibility to recharge the battery also when the voltage is close to zero with the maximum power of the device.

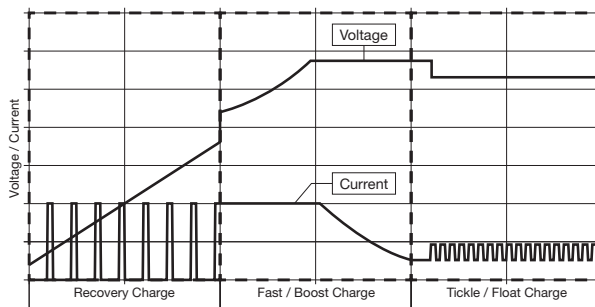
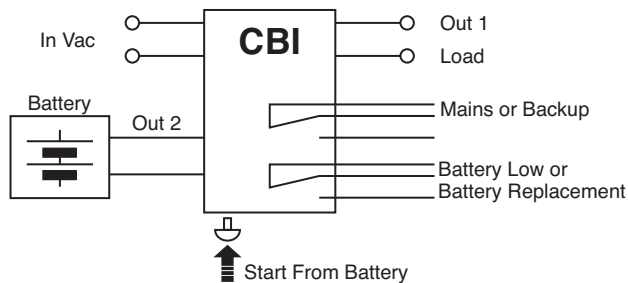



# CBI2420A DC UPS



## Features:

- Input: Single-phase 115 - 277 VAC
- Output Load: power supply 24 VDC; 20 A
- Output: Battery charging 24 VDC; 20 A
- Suited for the following battery types:  
Open Lead Acid, Sealed Lead Acid, lead Gel and Ni-Cd (option)
- Automatic diagnostic of battery status.
- Switching technology, output voltage 22-18.8 VDC
- Three charging levels: Boost, trickle and recovery
- Protection degree IP20 - DIN rail mountable

## INPUT

### Cat. No.

### CBI2420A

Nominal Input Voltage  
Voltage range  
Inrush Current ( $V_n - I_n$  nom. Load).  $I^2t$   
Frequency  
Input Current (115 – 230 VAC)  
Internal fuse (factory replaceable)  
External Fuse (recommended) MCB curve B

115 / 230 ~ 277 VAC  
90-135 / 180-305 VAC  
 $\leq 35 A \leq 5$  msec  
47 – 63 Hz  
8.0 ~ 4.2 A  
10 A  
16 A

## OUTPUT

Output Voltage ( $V_n$ ) / Nominal Current ( $I_n$ )  
Output Current  $I_n$   
Efficiency (at 50% of rated current)  
Turn-On delay after applying input voltage  
Start up with Strong Load (capacitive load)  
Dissipation power load max

24 VDC / 20A  
20 A  
 $\geq 91$  %  
1 sec. (max)  
Yes, Unlimited  
48 W

## PROTECTION

Short-circuit protection  
Over Load protection  
Over Voltage Output protection  
Over Temperature protection

Yes  
Yes  
Yes (typ. 35 VDC)  
Yes

## LOAD OUTPUT

Output voltage (at  $I_n$ )  
Nominal current  $I_{load}$   
Continuous current (without battery)  $I_{load} = I_n$   
Continuous current (with battery)  $I_{load} = I_n + I_{batt}$   
Max. Current Output Load (Main)  $I_{load}$  (4 sec.)  
Max. Current Output Load (Back Up)  $I_{load}$  (4 sec.)  
Push Button or Remote Input Control (RTCONN cable)  
Time Buffering; min (switch output off without main input)  
Protection alarm against total discharge  
Threshold alarm for battery almost flat

22 ~ 28.8 VDC  
 $1.1 \times I_n \pm 5\%$   
20 A  
40 A  
60 A max.  
40 A max.  
Start From Battery Without Main  
0.5,2,5,10,15,20,30,45,60, $\infty$ ; Require SW  
19-20V DC battery  
20-21 V DC battery

## BATTERY OUTPUT

Boost charge (25 °C) (at  $I_n$ )  
Max. time Bust Charge  
Min. time Bust Charge  
Trickle charge (25 °C) (at  $I_n$ )  
Jumper Configuration battery type (V cell) Ni-Cd (optional)  
Recovery Charge  
Charging current max  $I_{batt}$   
Charging current limiting  $I_{adj}$   
Reverse battery protection  
Sulfated battery check  
Detection of element in short circuit  
Quiescent Current  
Charging Curve automatic:  $I_{UoUo}$   
Remote Input Control (RTCONN cable)

28.8 VDC  
15 h  
1 min.  
27.5 VDC  
2.23; 2.25; 2.27; 2.30; NiCd: 1.50 (20 elem.)  
2 ~ 16 VDC  
20 A  $\pm 5\%$   
10 – 100 % /  $I_{batt}$   
Yes  
Yes by Jumper  
Yes  
 $\leq 5$  mA  
3 stage  
Boost /Trickle / Recovery

## OTHERS

Ambient temperature (operation)  
De Rating  $T_a > 50^\circ C$   
Ambient temperature Storage  
Humidity at 25°C no condensation  
Cooling  
MTBF (IEC 61709)

-25 – +70°C  
- 2.5%(In) / °C  
-40 – +85°C  
95%  
Auto convection  
> 300.000 h

# CBI2420A

## DC UPS

The Altech DC-UPS system is built to optimize power management. The available power is automatically allocated between load and battery, supplying power to the load is the first priority. For high inrush applications the charging power will reroute automatically to the load. In this case the maximum available current on the load output is two times the value of the device rated current.

The Battery Care concept based on algorithms that achieve rapid and automatic charging, battery optimization during charging time, flat batteries recovery and real time diagnostic. The Real Time Auto-diagnostic system, monitors battery faults, sulfated battery, short circuit battery elements, reverse polarity connection, battery disconnect. This conditions are detected and identified by the number of blinks of the diagnosis Led.

### Signal Output Contacts

Main or Backup Power	Yes
Battery Power Low	Yes
Battery Fault	Yes
Max. Current Rating (Resistive Load)	1A 30 VDC/60 VAC
Minimum Permissible Current Rating	1mA @ 5 VDC

### RJ45 Connection Input/Output

Temp. Comp. Battery (with ext. probe)	Yes - Optional
Remote monitoring display	Yes - Optional
Can Bus	No

### Environment

Insulation voltage (IN/OUT)	3000 VAC
Insulation voltage (input / ground)	1605 VAC
Insulation voltage (Output / ground)	500 VAC
Protection Class (EN/IEC 60529)	IP20
Pollution Degree Environment	2
Connection TB, Screw Terminal	4 mm <sup>2</sup> (30-10 AWG)
Protection class (Ground Connected)	Class I
Dimensions (WxHxD)	150x115x135 mm
5.91x4.53x5.32 in	
Weight (approx.)	1.55 kg (3.5 Lbs)

### Safety and EMC

Battery charger standard compliance	IEC/EN 60335-2-29
Safety standards compliance:	EN60950 / UL1950 / CE
Fire Detection and alarm compliance	EN54-4
EMC Directive	89/336/EEC
Charging cycle	DIN41773
Emission	IEC 61000-6-4
Immunity	IEC 61000-6-2

The Altech DC-UPS system is designed to charge and monitor all battery types, by selecting the battery type via jumpers. The predefined curves include Open Lead Acid, Sealed Lead Acid, Gel, Ni-Cd (optional) battery types. The charging curve are programmed to automatically switch between Recovery Charge, Boost charge and Trickle charge. The continuous battery efficiency monitoring, reduces battery damage risk and allows a safe operation in permanent connection.

A compact and rugged metal case with DIN rail mounting bracket provide an easy installation and an IP20 protection.

### Jumper for Battery Type Selection

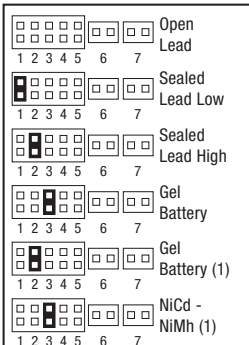

### Jumper for Functional Setting

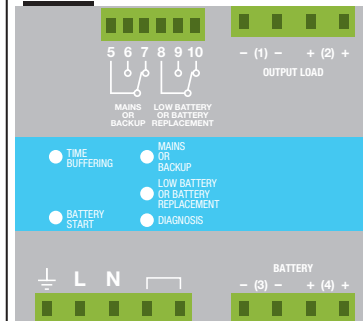
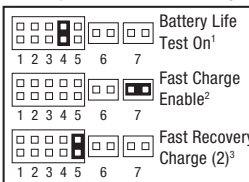

- 1 Jumper present: life test enabled.
- 2 Jumper present: fast test enabled.
- 3 Jumper present: fast recovery charge enabled only for size 3. Possibility to recharge the battery also when the voltage is close to zero with the maximum power of the device.

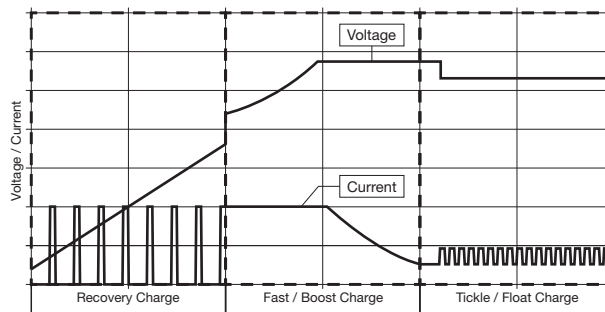
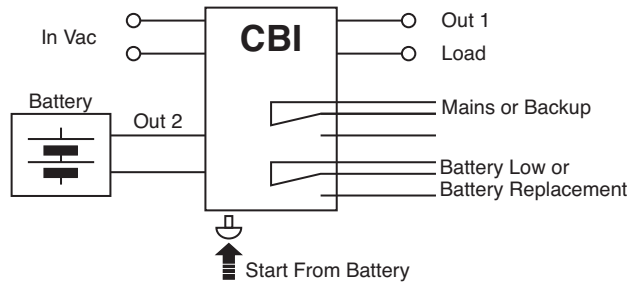



# CBI485A DC UPS



## Features:

- Input: Single-phase 115 - 277 VAC
- Output Load: power supply 48VDC; 5A
- Output: Battery charging 48VDC; 5A
- Suited for the following battery types:  
Open Lead Acid, Sealed Lead Acid, lead Gel and Ni-Cd (option)
- Automatic diagnostic of battery status.
- Switching technology, output voltage 44-57.6VDC
- Three charging levels: Boost, trickle and recovery
- Protection degree IP20 - DIN rail mountable

## INPUT

### Cat. No.

### CBI485A

Nominal Input Voltage	115 / 230 ~ 277 VAC
Voltage range	90-135 / 180-305 VAC
Inrush Current ( $V_n - I_n$ nom. Load). I <sup>2</sup> t	≤16 A ≤ 5 msec
Frequency	47 – 63 Hz
Input Current (115 – 230 VAC)	3.3 ~ 2.2 A
Internal fuse (factory replaceable)	6.3 A
External Fuse (recommended) MCB curve B	16 A

## OUTPUT

Output Voltage ( $V_n$ ) / Nominal Current ( $I_n$ )	48 VDC / 5A
Output Current $I_n$	5 A
Efficiency (at 50% of rated current)	≥ 83 %
Turn-On delay after applying input voltage	1.5 sec. (max)
Start up with Strong Load (capacitive load)	Yes, Unlimited
Dissipation power load max	28 W

## PROTECTION

Short-circuit protection	Yes
Over Load protection	Yes
Over Voltage Output protection	Yes (typ. 90 VDC)
Over Temperature protection	Yes

## LOAD OUTPUT

Output voltage (at $I_n$ )	44 ~ 57.6 VDC
Nominal current $I_{load}$	1.1 x $I_n$ A ± 5%
Continuous current (without battery) $I_{load} = I_n$	5 A
Continuous current (with battery) $I_{load} = I_n + I_{batt}$	10 A
Max. Current Output Load (Main) $I_{load}$ (4 sec.)	30 A max.
Max. Current Output Load (Back Up) $I_{load}$ (4 sec.)	15 A max.
Push Button or Remote Input Control (RTCONN cable)	Start From Battery Without Main
Time Buffering; min (switch output off without main input)	∞: standard 5 min.: Require SW
Protection alarm against total discharge	38-40V DC battery
Threshold alarm for battery almost flat	40-42V DC battery

## BATTERY OUTPUT

Boost charge (25 °C) (at $I_n$ )	56.6 VDC
Max. time Bust Charge	15 h
Min. time Bust Charge	1 min.
Trickle charge (25 °C) (at $I_n$ )	55 VDC
Jumper Configuration battery type (V cell) Ni-Cd (optional)	2.23; 2.25; 2.27; 2.30; NiCd: 1.50 (40 elem.)
Recovery Charge	2 ~ 24 VDC
Charging current max $I_{batt}$	2 A ± 5%
Charging current limiting $I_{adj}$	20 – 100 % / $I_{batt}$
Reverse battery protection	Yes
Sulfated battery check	Yes by Jumper
Detection of element in short circuit	Yes
Quiescent Current	≤ 5 mA
Charging Curve automatic: $I_{UoUo}$	3 stage
Remote Input Control (RTCONN cable)	Boost /Trickle / Recovery

## OTHERS

Ambient temperature (operation)	-25 – +70°C
De Rating $T_a > 50°C$	- 2.5%(In) / °C
Ambient temperature Storage	-40 – +85°C
Humidity at 25°C no condensation	95%
Cooling	Auto convection
MTBF (IEC 61709)	> 300.000 h

# CBI485A

## DC UPS

The Altech DC-UPS system is built to optimize power management. The available power is automatically allocated between load and battery, supplying power to the load is the first priority. For high inrush applications the charging power will reroute automatically to the load. In this case the maximum available current on the load output is two times the value of the device rated current.

The Battery Care concept based on algorithms that achieve rapid and automatic charging, battery optimization during charging time, flat batteries recovery and real time diagnostic. The Real Time Auto-diagnostic system, monitors battery faults, sulfated battery, short circuit battery elements, reverse polarity connection, battery disconnect. This conditions are detected and identified by the number of blinks of the diagnosis Led.

### Signal Output Contacts

Main or Backup Power	Yes
Battery Power Low	Yes
Battery Fault	Yes
Max. Current Rating (Resistive Load)	1A 30 VDC/60 VAC
Minimum Permissible Current Rating	1mA @ 5 VDC

### RJ45 Connection Input/Output

Temp. Comp. Battery (with ext. probe)	Yes - Optional
Remote monitoring display	Yes - Optional
Can Bus	No

### Environment

Insulation voltage (IN/OUT)	3000 VAC
Insulation voltage (input / ground)	1605 VAC
Insulation voltage (Output / ground)	500 VAC
Protection Class (EN/IEC 60529)	IP20
Pollution Degree Environment	2
Connection TB, Screw Terminal	2.5 mm <sup>2</sup> (24-14 AWG)
Protection class (Ground Connected)	Class I
Dimensions (WxHxD)	100x115x135 mm
2.95x4.53x5.32 in	
Weight (approx.)	0.85 kg (1.9 Lbs)

### Safety and EMC

Battery charger standard compliance	IEC/EN 60335-2-29
Safety standards compliance:	EN60950 / UL1950 / CE
Fire Detection and alarm compliance	EN54-4
EMC Directive	89/336/EEC
Charging cycle	DIN41773
Emission	IEC 61000-6-4
Immunity	IEC 61000-6-2

The Altech DC-UPS system is designed to charge and monitor all battery types, by selecting the battery type via jumpers. The predefined curves include Open Lead Acid, Sealed Lead Acid, Gel, Ni-Cd (optional) battery types. The charging curve are programmed to automatically switch between Recovery Charge, Boost charge and Trickle charge. The continuous battery efficiency monitoring, reduces battery damage risk and allows a safe operation in permanent connection.

A compact and rugged metal case with DIN rail mounting bracket provide an easy installation and an IP20 protection.

### Jumper for Battery Type Selection

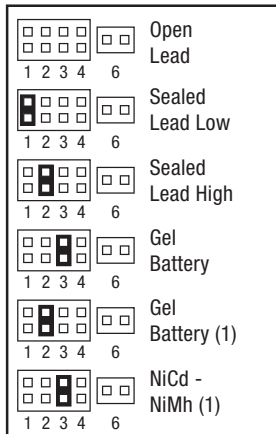

### Jumper for Functional Setting

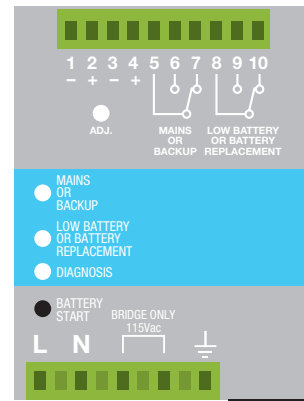
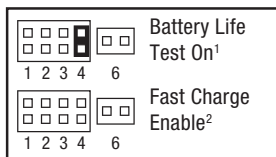

- 1 Jumper present: life test enabled.
- 2 Jumper present: fast test enabled.
- 3 Jumper present: fast recovery charge enabled only for size 3. Possibility to recharge the battery also when the voltage is close to zero with the maximum power of the device.

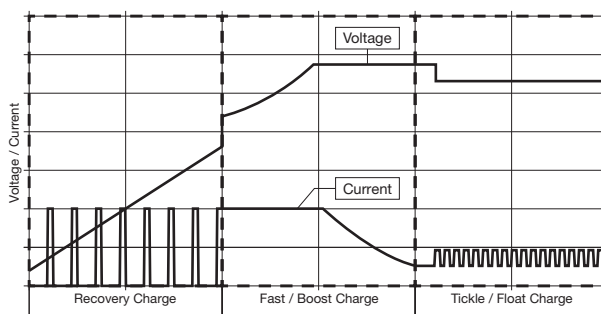
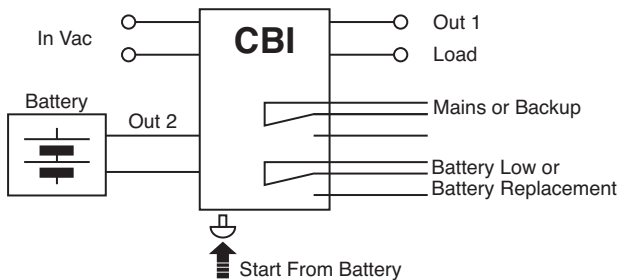





# CBI4810A DC UPS



## Features:

- Input: Single-phase 115 - 277 VAC
- Output Load: power supply 48VDC; 10A
- Output: Battery charging 48VDC; 10A
- Suited for the following battery types:  
Open Lead Acid, Sealed Lead Acid, lead Gel and Ni-Cd (option)
- Automatic diagnostic of battery status.
- Switching technology, output voltage 44-57.6VDC
- Three charging levels: Boost, trickle and recovery
- Protection degree IP20 - DIN rail mountable

## INPUT

### Cat. No.

### CBI4810A

Nominal Input Voltage	115 / 230 ~ 277 VAC
Voltage range	90-135 / 180-305 VAC
Inrush Current ( $V_n - I_n$ nom. Load). I <sup>2</sup> t	≤35 A ≤ 5 msec
Frequency	47 – 63 Hz
Input Current (115 – 230 VAC)	8.0 ~ 4.2 A
Internal fuse (factory replaceable)	10 A
External Fuse (recommended) MCB curve B	16 A

## OUTPUT

Output Voltage ( $V_n$ ) / Nominal Current ( $I_n$ )	48 VDC / 10A
Output Current $I_n$	10 A
Efficiency (at 50% of rated current)	≥ 91 %
Turn-On delay after applying input voltage	1 sec. (max)
Start up with Strong Load (capacitive load)	Yes, Unlimited
Dissipation power load max	54 W

## PROTECTION

Short-circuit protection	Yes
Over Load protection	Yes
Over Voltage Output protection	Yes (typ. 90 VDC)
Over Temperature protection	Yes

## LOAD OUTPUT

Output voltage (at $I_n$ )	44 ~ 57.6 VDC
Nominal current $I_{load}$	1.1 x $I_n$ A ± 5%
Continuous current (without battery) $I_{load} = I_n$	10 A
Continuous current (with battery) $I_{load} = I_n + I_{batt}$	20 A
Max. Current Output Load (Main) $I_{load}$ (4 sec.)	30 A max.
Max. Current Output Load (Back Up) $I_{load}$ (4 sec.)	20 A max.
Push Button or Remote Input Control (RTCONN cable)	Start From Battery Without Main
Time Buffering; min (switch output off without main input)	0.5, 1, 3, 5, 10, 15, 20, 30, 45, 60, ∞; Require SW
Protection alarm against total discharge	38-40V DC battery
Threshold alarm for battery almost flat	40-42V DC battery

## BATTERY OUTPUT

Boost charge (25 °C) (at $I_n$ )	56.6 VDC
Max. time Bust Charge	15 h
Min. time Bust Charge	1 min.
Trickle charge (25 °C) (at $I_n$ )	55 VDC
Jumper Configuration battery type (V cell) Ni-Cd (optional)	2.23; 2.25; 2.27; 2.30; NiCd: 1.50 (40 elem.)
Recovery Charge	2 ~ 24 VDC
Charging current max $I_{batt}$	10 A ± 5%
Charging current limiting $I_{adj}$	10 – 100 % / $I_{batt}$
Reverse battery protection	Yes
Sulfated battery check	Yes by Jumper
Detection of element in short circuit	Yes
Quiescent Current	≤ 5 mA
Charging Curve automatic: $I_{UoUo}$	3 stage
Remote Input Control (RTCONN cable)	Boost /Trickle / Recovery

## OTHERS

Ambient temperature (operation)	-25 – +70°C
De Rating $T_a > 50$ °C	- 2.5%( $I_n$ ) / °C
Ambient temperature Storage	-40 – +85°C
Humidity at 25°C no condensation	95%
Cooling	Auto convection
MTBF (IEC 61709)	> 300.000 h



# CBI4810A

## DC UPS

The Altech DC-UPS system is built to optimize power management. The available power is automatically allocated between load and battery, supplying power to the load is the first priority. For high inrush applications the charging power will reroute automatically to the load. In this case the maximum available current on the load output is two times the value of the device rated current.

The Battery Care concept based on algorithms that achieve rapid and automatic charging, battery optimization during charging time, flat batteries recovery and real time diagnostic. The Real Time Auto-diagnostic system, monitors battery faults, sulfated battery, short circuit battery elements, reverse polarity connection, battery disconnect. This conditions are detected and identified by the number of blinks of the diagnosis Led.

### Signal Output Contacts

Main or Backup Power	Yes
Battery Power Low	Yes
Battery Fault	Yes
Max. Current Rating (Resistive Load)	1A 30 VDC/60 VAC
Minimum Permissible Current Rating	1mA @ 5 VDC

### RJ45 Connection Input/Output

Temp. Comp. Battery (with ext. probe)	Yes - Optional
Remote monitoring display	Yes - Optional
Can Bus	Yes - Optional

### Environment

Insulation voltage (IN/OUT)	3000 VAC
Insulation voltage (input / ground)	1605 VAC
Insulation voltage (Output / ground)	500 VAC
Protection Class (EN/IEC 60529)	IP20
Pollution Degree Environment	2
Connection TB, Screw Terminal	4 mm <sup>2</sup> (30-10 AWG)
Protection class (Ground Connected)	Class I
Dimensions (WxHxD)	150x115x135 mm
5.91x4.53x5.32 in	
Weight (approx.)	1.55 kg (3.5 Lbs)

### Safety and EMC

Battery charger standard compliance	IEC/EN 60335-2-29
Safety standards compliance:	EN60950 / UL1950 / CE
Fire Detection and alarm compliance	EN54-4
EMC Directive	89/336/EEC
Charging cycle	DIN41773
Emission	IEC 61000-6-4
Immunity	IEC 61000-6-2

The Altech DC-UPS system is designed to charge and monitor all battery types, by selecting the battery type via jumpers. The predefined curves include Open Lead Acid, Sealed Lead Acid, Gel, Ni-Cd (optional) battery types. The charging curve are programmed to automatically switch between Recovery Charge, Boost charge and Trickle charge. The continuous battery efficiency monitoring, reduces battery damage risk and allows a safe operation in permanent connection.

A compact and rugged metal case with DIN rail mounting bracket provide an easy installation and an IP20 protection.

### Jumper for Battery Type Selection

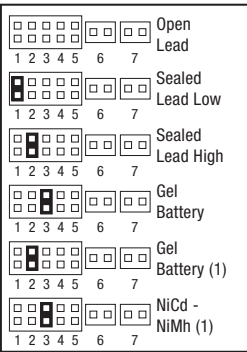

### Jumper for Functional Setting

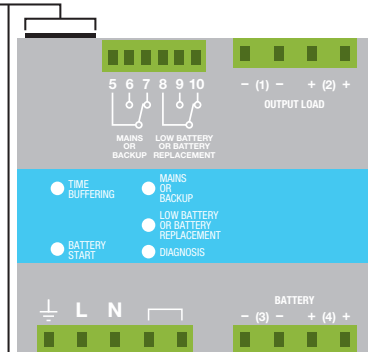
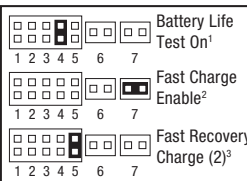

- 1 Jumper present: life test enabled.
- 2 Jumper present: fast test enabled.
- 3 Jumper present: fast recovery charge enabled only for size 3. Possibility to recharge the battery also when the voltage is close to zero with the maximum power of the device.

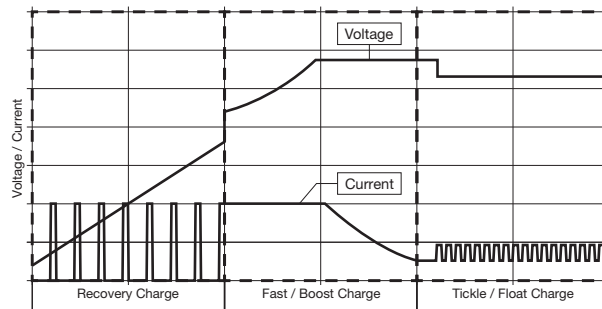
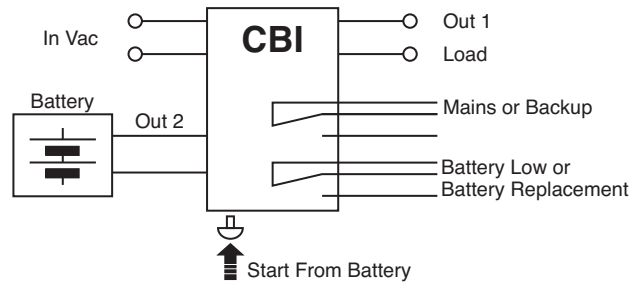



# CBI2803648A DC UPS



## Features:

- Input: Single-phase 115 - 277 VAC
- Output Load: power supply 36/48VDC; 7/5A
- Output: Battery charging 36/48VDC; 7/5A
- Suited for the following battery types:  
Open Lead Acid, Sealed Lead Acid, lead Gel and Ni-Cd (option)
- Automatic diagnostic of battery status.
- Switching technology, output voltage 33-43.2/44-57.6VDC
- Three charging levels: Boost, trickle and recovery
- Protection degree IP20 - DIN rail mountable

## INPUT

### Cat. No.

### CBI2803648A

Nominal Input Voltage  
Voltage range  
Inrush Current ( $V_n - I_n$  nom. Load).  $I^2t$   
Frequency  
Input Current (115 – 230 VAC)  
Internal fuse (factory replaceable)  
External Fuse (recommended) MCB curve B

115 ~ 230 ~ 277 VAC  
90 ~ 305 VAC  
 $\leq 16 A \leq 5$  msec  
47 – 63 Hz  
3.3 ~ 2.2 A  
6.3 A  
16 A

## OUTPUT

Output Voltage ( $V_n$ ) / Nominal Power (W)  
Output Current  $I_n$   
Efficiency (at 50% of rated current)  
Turn-On delay after applying input voltage  
Start up with Strong Load (capacitive load)  
Dissipation power load max

36 / 48 VDC / 270W (jumper selection)  
7 A @36VDC / 5A @48VDC  
 $\geq 91$  %  
1.5 sec. (max)  
Yes, Unlimited  
30 W

## PROTECTION

Short-circuit protection  
Over Load protection  
Over Voltage Output protection  
Over Temperature protection

Yes  
Yes  
Yes (typ. 90 VDC)  
Yes

## LOAD OUTPUT

Output voltage (at  $I_n$ )  
Nominal current  $I_{load}$   
Continuous current (without battery)  $I_{load} = I_n$   
Continuous current (with battery)  $I_{load} = I_n + I_{batt}$   
Max. Current Output Load (Main)  $I_{load}$  (4 sec.)  
Max. Current Output Load (Back Up)  $I_{load}$  (4 sec.)  
Push Button or Remote Input Control (RTCONN cable)  
Time Buffering; min (switch output off without main input)  
Protection alarm against total discharge  
Threshold alarm for battery almost flat

33 ~ 43.2 / 44 ~ 57.6 VDC  
 $1.1 \times I_n \pm 5\%$   
7 A @ 36VDC / 5A @ 48VDC  
14 A @ 36VDC / 10A @ 48VDC max.  
21 A @ 36VDC / 15A @ 48VDC max.  
14 A @ 36VDC / 10A @ 48VDC max.  
Start From Battery Without Main  
0.5,2,5,10,15,20,30,45,60, $\infty$   
26-28 / 38-40V DC battery  
29-31 / 40-42V DC battery

## BATTERY OUTPUT

Boost charge (25 °C) (at  $I_n$ )  
Max. time Bust Charge  
Min. time Bust Charge  
Trickle charge (25 °C) (at  $I_n$ )  
Jumper Configuration battery type (V cell) Ni-Cd (optional)  
Recovery Charge  
Charging current max  $I_{batt}$   
Charging current limiting  $I_{adj}$   
Reverse battery protection  
Sulfated battery check  
Detection of element in short circuit  
Quiescent Current  
Charging Curve automatic:  $I_{UoUo}$   
Remote Input Control (RTCONN cable)

43.2 @ 36VDC / 57.6 @ 48VDC  
15 h  
1 min.  
41.4 @ 36VDC / 55.2 @ 48VDC  
2.23; 2.25; 2.27; 2.30; NiCd: 1.50V/element  
2 ~ 18 / 2 ~ 24VDC  
7 A @ 36VDC / 5A @ 48VDC  $\pm 5\%$   
10 – 100 % /  $I_{batt}$   
Yes  
Yes by Jumper  
Yes  
 $\leq 5$  mA  
4 stage  
Boost / Trickle

## OTHERS

Ambient temperature (operation)  
De Rating  $T_a > 50^\circ C$   
Ambient temperature Storage  
Humidity at 25°C no condensation  
Cooling  
MTBF (IEC 61709)

-25 – +70°C  
- 2.5%( $I_n$ ) / °C  
-40 – +85°C  
95%  
Auto convection  
> 300.000 h

# CBI2803648A

## DC UPS

The Altech DC-UPS system is built to optimize power management. The available power is automatically allocated between load and battery, supplying power to the load is the first priority. For high inrush applications the charging power will reroute automatically to the load. In this case the maximum available current on the load output is two times the value of the device rated current.

The Battery Care concept based on algorithms that achieve rapid and automatic charging, battery optimization during charging time, flat batteries recovery and real time diagnostic. The Real Time Auto-diagnostic system, monitors battery faults, sulfated battery, short circuit battery elements, reverse polarity connection, battery disconnect. This conditions are detected and identified by the number of blinks of the diagnosis Led.

### Signal Output Contacts

Main or Backup Power	Yes
Battery Power Low	Yes
Battery Fault	Yes
Max. Current Rating (Resistive Load)	1A 30 VDC/60 VAC
Minimum Permissible Current Rating	1mA @ 5 VDC

### RJ45 Connection Input/Output

Temp. Comp. Battery (with ext. probe)	Yes - Optional
Remote monitoring display	Yes - Optional
Can Bus	Yes - Optional

### Environment

Insulation voltage (IN/OUT)	3000 VAC
Insulation voltage (input / ground)	1605 VAC
Insulation voltage (Output / ground)	500 VAC
Protection Class (EN/IEC 60529)	IP20
Pollution Degree Environment	2
Connection TB, Screw Terminal	2.5 mm <sup>2</sup> (24-14 AWG)
Protection class (Ground Connected)	Class I
Dimensions (WxHxD)	115x115x135 mm
2.95x4.53x5.32 in	
Weight (approx.)	0.85 kg (1.9 Lbs)

### Safety and EMC

Battery charger standard compliance	IEC/EN 60335-2-29
Safety standards compliance:	EN60950 / UL1950 / CE
Fire Detection and alarm compliance	EN54-4
EMC Directive	89/336/EEC
Charging cycle	DIN41773
Emission	IEC 61000-6-4
Immunity	IEC 61000-6-2

The Altech DC-UPS system is designed to charge and monitor all battery types, by selecting the battery type via jumpers. The predefined curves include Open Lead Acid, Sealed Lead Acid, Gel, Ni-Cd (optional) battery types. The charging curve are programmed to automatically switch between Recovery Charge, Boost charge and Trickle charge. The continuous battery efficiency monitoring, reduces battery damage risk and allows a safe operation in permanent connection.

A compact and rugged metal case with DIN rail mounting bracket provide an easy installation and an IP20 protection.

### Jumper for Battery Type Selection

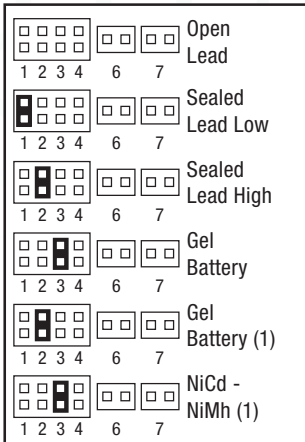

### Jumper for Functional Setting

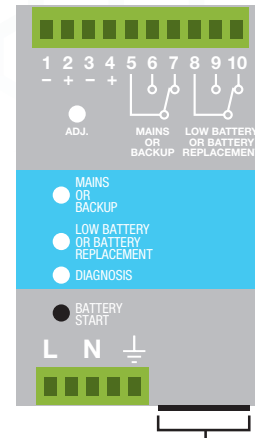
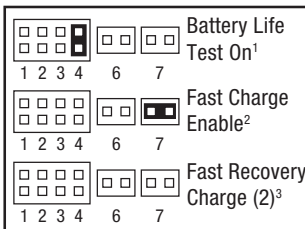

- 1 Jumper present: life test enabled.
- 2 Jumper present: fast test enabled.
- 3 Jumper present: fast recovery charge enabled only for size 3. Possibility to recharge the battery also when the voltage is close to zero with the maximum power of the device.

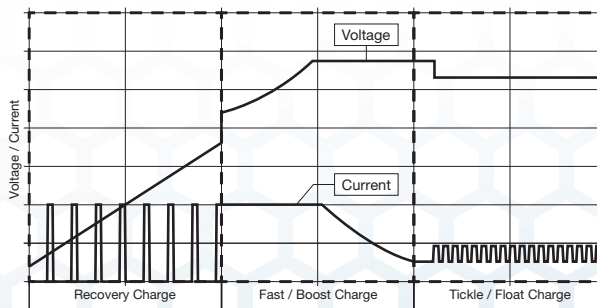
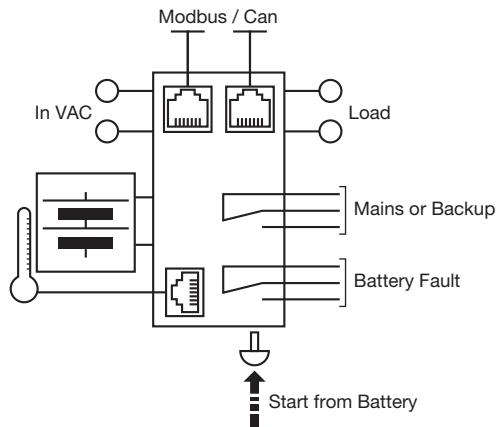

PSC Class 2 Series Compact Housing

PSA Flex Series 1 Phase

PSB Flex Series 2 & 3 Phase

PS-S Slim Series Plastic Housing

PS Low Profile Series Plastic Housing

PS Industrial Series 1, 2 & 3 Phase

PS C & W Series 1 and 2 Phase

CBI Type DC UPS Systems

CB Type Battery Chargers

Accessories

Appendix



# CBI2801224A DC UPS



## Features:

- Input: Single-phase 115 - 277 VAC
- Output Load: power supply 12 VDC; 15 A / 234VDC; 10A
- Output: Battery charging 12 VDC; 15 A / 24VDC; 10A
- Suited for the following battery types:  
Open Lead Acid, Sealed Lead Acid, lead Gel and Ni-Cd (option)
- Automatic diagnostic of battery status.
- Switching technology, output voltage 10-14.4 VDC / 22-28.8VDC
- Three charging levels: Boost, trickle and recovery
- Protection degree IP20 - DIN rail mountable

## INPUT

### Cat. No.

### CBI2801224A

Nominal Input Voltage	115 ~ 230 ~ 277 VAC
Voltage range	90 ~ 305 VAC
Inrush Current ( $V_n - I_n$ nom. Load). I <sup>2</sup> t	≤16 A ≤ 5 msec
Frequency	47 – 63 Hz
Input Current (115 – 230 VAC)	3.3 ~ 2.2 A
Internal fuse (factory replaceable)	6.3 A
External Fuse (recommended) MCB curve B	16 A

## OUTPUT

Output Voltage ( $V_n$ ) / Nominal Power (W)	12 / 24 VDC / 270W (jumper selection)
Output Current $I_n$	15 A @ 12VDC / 10A @ 24VDC
Efficiency (at 50% of rated current)	≥ 91 %
Turn-On delay after applying input voltage	1 sec. (max)
Start up with Strong Load (capacitive load)	Yes, Unlimited
Dissipation power load max	28 W

## PROTECTION

Short-circuit protection	Yes
Over Load protection	Yes
Over Voltage Output protection	Yes (typ. 35 VDC)
Over Temperature protection	Yes

## LOAD OUTPUT

Output voltage (at $I_n$ )	10-14.4 / 22-28.8 VDC
Nominal current $I_{load}$	1.1 x $I_n$ A ± 5%
Continuous current (without battery) $I_{load} = I_n$	15 A @ 12VDC / 10A @ 24VDC
Continuous current (with battery) $I_{load} = I_n + I_{batt}$	30 A @ 12VDC / 20A @ 24VDC max.
Max. Current Output Load (Main) $I_{load}$ (4 sec.)	45 A @ 12VDC / 30A @ 24VDC max.
Max. Current Output Load (Back Up) $I_{load}$ (4 sec.)	30 A @ 12VDC / 20A @ 24VDC max.
Push Button or Remote Input Control (RTCONN cable)	Start From Battery Without Main
Time Buffering; min (switch output off without main input)	0.5,2,5,10,15,20,30,45,60,∞
Protection alarm against total discharge	10-11 / 20-21V DC battery
Threshold alarm for battery almost flat	9-10 / 19-20V DC battery

## BATTERY OUTPUT

Boost charge (25 °C) (at $I_n$ )	14.4 @ 12VDC / 28.8 @ 24VDC
Max. time Bust Charge	15 h
Min. time Bust Charge	1 min.
Trickle charge (25 °C) (at $I_n$ )	13.8 @ 12VDC / 27.6 @ 24VDC
Jumper Configuration battery type (V cell) Ni-Cd (optional)	2.23; 2.25; 2.27; 2.30; NiCd: 1.50V / element
Recovery Charge	2 ~ 18 / 2 ~ 24VDC
Charging current max $I_{batt}$	15 A @ 12VDC / 10A @ 24VDC ± 5%
Charging current limiting $I_{adj}$	10 – 100 % / $I_{batt}$
Reverse battery protection	Yes
Sulfated battery check	Yes by Jumper
Detection of element in short circuit	Yes
Quiescent Current	≤ 5 mA
Charging Curve automatic: $I_{UoUo}$	4 stage
Remote Input Control (RTCONN cable)	Boost / Trickle

## OTHERS

Ambient temperature (operation)	-25 – +70°C
De Rating $T_a > 50$ °C	- 2.5%( $I_n$ ) / °C
Ambient temperature Storage	-40 – +85°C
Humidity at 25°C no condensation	95%
Cooling	Auto convection
MTBF (IEC 61709)	> 300.000 h

# CBI2801224A

## DC UPS

The Altech DC-UPS system is built to optimize power management. The available power is automatically allocated between load and battery, supplying power to the load is the first priority. For high inrush applications the charging power will reroute automatically to the load. In this case the maximum available current on the load output is two times the value of the device rated current.

The Battery Care concept based on algorithms that achieve rapid and automatic charging, battery optimization during charging time, flat batteries recovery and real time diagnostic. The Real Time Auto-diagnostic system, monitors battery faults, sulfated battery, short circuit battery elements, reverse polarity connection, battery disconnect. This conditions are detected and identified by the number of blinks of the diagnosis Led.

### Signal Output Contacts

Main or Backup Power	Yes
Battery Power Low	Yes
Battery Fault	Yes
Max. Current Rating (Resistive Load)	1A 30 VDC/60 VAC
Minimum Permissible Current Rating	1mA @ 5 VDC

### RJ45 Connection Input/Output

Temp. Comp. Battery (with ext. probe)	Yes – (Aux 1)
ModBus / Can Bus	Yes – (Aux 2)
ModBus / Can Bus	Yes – (Aux 3)

### Environment

Insulation voltage (IN/OUT)	3000 VAC
Insulation voltage (input / ground)	1605 VAC
Insulation voltage (Output / ground)	500 VAC
Protection Class (EN/IEC 60529)	IP20
Pollution Degree Environment	2
Connection TB, Screw Terminal	2.5 mm <sup>2</sup> (24-14 AWG)
Protection class (Ground Connected)	Class I
Dimensions (WxHxD)	115x115x135 mm
2.95x4.53x5.32 in	
Weight (approx.)	0.85 kg (1.9 Lbs)

### Safety and EMC

Battery charger standard compliance	IEC/EN 60335-2-29
Safety standards compliance:	EN60950 / UL1950 / CE
Fire Detection and alarm compliance	EN54-4
EMC Directive	89/336/EEC
Charging cycle	DIN41773
Emission	IEC 61000-6-4
Immunity	IEC 61000-6-2

The Altech DC-UPS system is designed to charge and monitor all battery types, by selecting the battery type via jumpers. The predefined curves include Open Lead Acid, Sealed Lead Acid, Gel, Ni-Cd (optional) battery types. The charging curve are programmed to automatically switch between Recovery Charge, Boost charge and Trickle charge. The continuous battery efficiency monitoring, reduces battery damage risk and allows a safe operation in permanent connection.

A compact and rugged metal case with DIN rail mounting bracket provide an easy installation and an IP20 protection.

### Jumper for Battery Type Selection

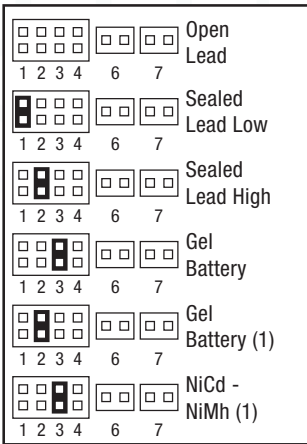

### Jumper for Functional Setting

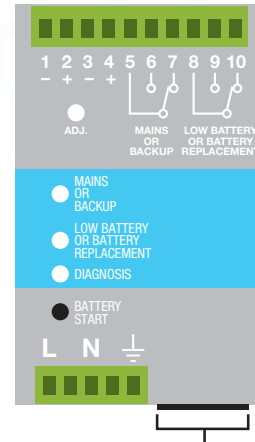
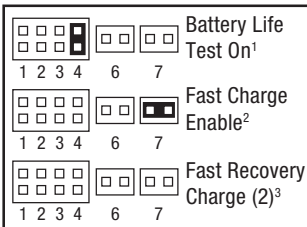

- 1 Jumper present: life test enabled.
- 2 Jumper present: fast test enabled.
- 3 Jumper present: fast recovery charge enabled only for size 3. Possibility to recharge the battery also when the voltage is close to zero with the maximum power of the device.

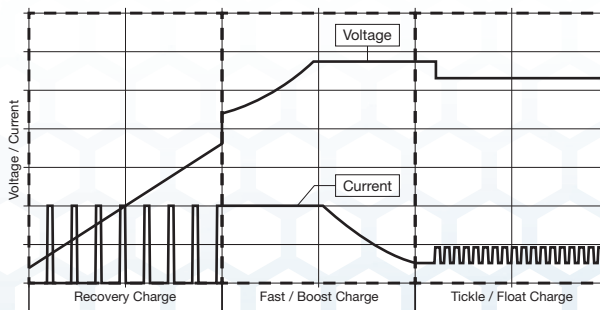
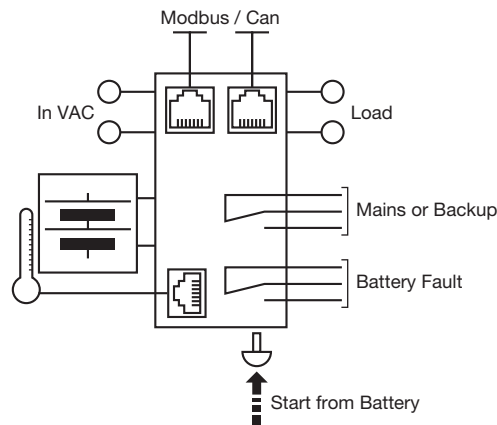

PSC Class 2 Series Compact Housing

PSA Flex Series 1 Phase

PSB Flex Series 2 & 3 Phase

PS-S Slim Series Plastic Housing

PS Low Profile Series Plastic Housing

PS Industrial Series 1, 2 & 3 Phase

PS C & W Series 1 and 2 Phase

CBI Type DC UPS Systems

CB Type Battery Chargers

Accessories

Appendix





# CBI2801224B DC UPS



## Features:

- Input: Single-phase 230 - 500 VAC
- Output Load: power supply 12 VDC; 15 A / 24VDC; 10A
- Output: Battery charging 12 VDC; 15 A / 24VDC; 10A
- Suited for the following battery types:  
Open Lead Acid, Sealed Lead Acid, lead Gel and Ni-Cd (option)
- Automatic diagnostic of battery status.
- Switching technology, output voltage 10-14.4 VDC / 22-28.8 VDC
- Three charging levels: Boost, trickle and recovery
- Protection degree IP20 - DIN rail mountable

## INPUT

### Cat. No.

### CBI2801224B

Nominal Input Voltage  
Voltage range  
Inrush Current ( $V_n - I_n$  nom. Load). I<sup>2</sup>t  
Frequency  
Input Current (115 – 230 VAC)  
Internal fuse (factory replaceable)  
External Fuse (recommended) MCB curve B

230 ~ 400 ~ 500 VAC  
180-264 / 330-550 VAC  
≤16 A ≤ 5 msec  
47 – 63 Hz  
2.2 -1.4 -1.0 A  
4 A  
16 A

## OUTPUT

Output Voltage ( $V_n$ ) / Nominal Power (W)  
Output Current  $I_n$   
Efficiency (at 50% of rated current)  
Turn-On delay after applying input voltage  
Start up with Strong Load (capacitive load)  
Dissipation power load max

12 / 24 VDC / 270W (jumper selection)  
15 A @ 12VDC / 10A @ 24VDC  
≥ 91 %  
1 sec. (max)  
Yes, Unlimited  
28 W

## PROTECTION

Short-circuit protection  
Over Load protection  
Over Voltage Output protection  
Over Temperature protection

Yes  
Yes  
Yes (typ. 35 VDC)  
Yes

## LOAD OUTPUT

Output voltage (at  $I_n$ )  
Nominal current  $I_{load}$   
Continuous current (without battery)  $I_{load} = I_n$   
Continuous current (with battery)  $I_{load} = I_n + I_{batt}$   
Max. Current Output Load (Main)  $I_{load}$  (4 sec.)  
Max. Current Output Load (Back Up)  $I_{load}$  (4 sec.)  
Push Button or Remote Input Control (RTCONN cable)  
Time Buffering; min (switch output off without main input)  
Protection alarm against total discharge  
Threshold alarm for battery almost flat

10-14.4 / 22-28.8 VDC  
1.1 x  $I_n$  A ± 5%  
15 A @ 12VDC / 10A @ 24VDC  
30 A @ 12VDC / 20A @ 24VDC max.  
45 A @ 12VDC / 30A @ 24VDC max.  
30 A @ 12VDC / 20A @ 24VDC max.  
Start From Battery Without Main  
0.5,2,5,10,15,20,30,45,60,∞  
10-11 / 20-21V DC battery  
9-10 / 19-20V DC battery

## BATTERY OUTPUT

Boost charge (25 °C) (at  $I_n$ )  
Max. time Bust Charge  
Min. time Bust Charge  
Trickle charge (25 °C) (at  $I_n$ )  
Jumper Configuration battery type (V cell) Ni-Cd (optional)  
Recovery Charge  
Charging current max  $I_{batt}$   
Charging current limiting  $I_{adj}$   
Reverse battery protection  
Sulfated battery check  
Detection of element in short circuit  
Quiescent Current  
Charging Curve automatic:  $I_{UoUo}$   
Remote Input Control (RTCONN cable)

14.4 @ 12VDC / 28.8 @ 24VDC  
15 h  
1 min.  
13.8 @ 12VDC / 27.6 @ 24VDC  
2.23; 2.25; 2.27; 2.30; NiCd: 1.50 / element  
2 ~ 18 / 2 ~ 24VDC  
15 A @ 12VDC / 10A @ 24VDC ± 5%  
10 – 100 % /  $I_{batt}$   
Yes  
Yes by Jumper  
Yes  
≤ 5 mA  
4 stage  
Boost / Trickle

## OTHERS

Ambient temperature (operation)  
De Rating  $T_a > 50^\circ\text{C}$   
Ambient temperature Storage  
Humidity at 25°C no condensation  
Cooling  
MTBF (IEC 61709)

-25 – +70°C  
- 2.5%( $I_n$ ) / °C  
-40 – +85°C  
95%  
Auto convention  
> 300.000 h

# CBI2801224B

## DC UPS

The Altech DC-UPS system is built to optimize power management. The available power is automatically allocated between load and battery, supplying power to the load is the first priority. For high inrush applications the charging power will reroute automatically to the load. In this case the maximum available current on the load output is two times the value of the device rated current.

The Battery Care concept based on algorithms that achieve rapid and automatic charging, battery optimization during charging time, flat batteries recovery and real time diagnostic The Real Time Auto-diagnostic system, monitors battery faults, sulfated battery, short circuit battery elements, reverse polarity connection, battery disconnect. This conditions are detected and identified by the number of blinks of the diagnosis Led.

### Signal Output Contacts

Main or Backup Power	Yes
Battery Power Low	Yes
Battery Fault	Yes
Max. Current Rating (Resistive Load)	1A 30 VDC/60 VAC
Minimum Permissible Current Rating	1mA @ 5 VDC

### RJ45 Connection Input/Output

Temp. Comp. Battery (with ext. probe)	Yes – (Aux 1)
ModBus / Can Bus	Yes – (Aux 2)
ModBus / Can Bus	Yes – (Aux 3)

### Environment

Insulation voltage (IN/OUT)	3000 VAC
Insulation voltage (input / ground)	1605 VAC
Insulation voltage (Output / ground)	500 VAC
Protection Class (EN/IEC 60529)	IP20
Pollution Degree Environment	2
Connection TB, Screw Terminal	2.5 mm <sup>2</sup> (24-14 AWG)
Protection class (Ground Connected)	Class I
Dimensions (WxHxD)	115x115x135 mm
2.95x4.53x5.32 in	
Weight (approx.)	0.85 kg (1.9 Lbs)

### Safety and EMC

Battery charger standard compliance	IEC/EN 60335-2-29
Safety standards compliance:	EN60950 / UL1950 / CE
Fire Detection and alarm compliance	EN54-4
EMC Directive	89/336/EEC
Charging cycle	DIN41773
Emission	IEC 61000-6-4
Immunity	IEC 61000-6-2

The Altech DC-UPS system is designed to charge and monitor all battery types, by selecting the battery type via jumpers. The predefined curves include Open Lead Acid, Sealed Lead Acid, Gel, Ni-Cd (optional) battery types. The charging curve are programmed to automatically switch between Recovery Charge, Boost charge and Trickle charge. The continuous battery efficiency monitoring, reduces battery damage risk and allows a safe operation in permanent connection.

A compact and rugged metal case with DIN rail mounting bracket provide an easy installation and an IP20 protection.

### Jumper for Battery Type Selection

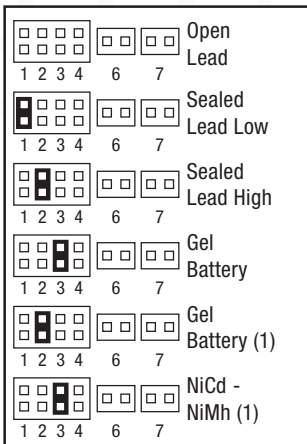

### Jumper for Functional Setting

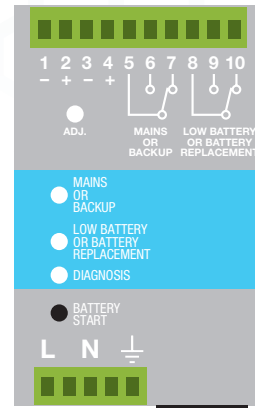
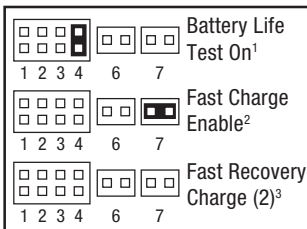

- 1 Jumper present: life test enabled.
- 2 Jumper present: fast test enabled.
- 3 Jumper present: fast recovery charge enabled only for size 3. Possibility to recharge the battery also when the voltage is close to zero with the maximum power of the device.

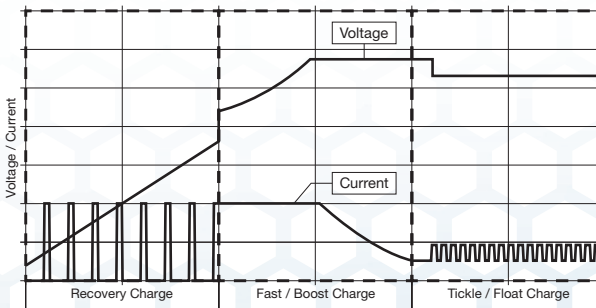
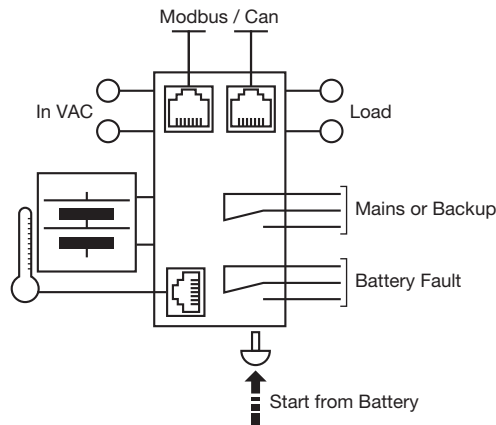

PSC Class 2 Series Compact Housing

PSA Flex Series 1 Phase

PSB Flex Series 2 & 3 Phase

PS-S Slim Series Plastic Housing

PS Low Profile Series Plastic Housing

PS Industrial Series 1, 2 & 3 Phase

PS C & W Series 1 and 2 Phase

CBI Type DC UPS Systems

CB Type Battery Chargers

Accessories

Appendix





## CB Type Intelligent Battery Chargers

The CB type battery chargers are designed and manufactured with a wide input voltage, single or two phase 115-230-277 VAC.

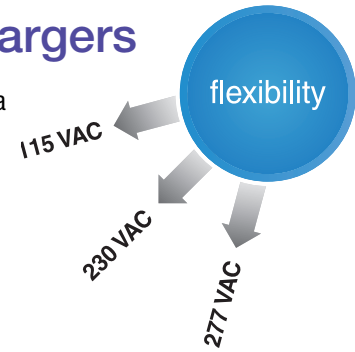

### Technology

The CB series is a new range of battery chargers based on two strategic know-how elements.

#### Switching technology

We have 25 year experience in design of advanced stabilized switching technology power supplies. A battery charger based on this technology is much more efficient and much smaller and lighter than traditional linear technology battery chargers.

#### Micro-processor and Battery Care

Unlike most other state-of-the-art battery chargers, the CB series is equipped with a micro-processor which controls the charging process and enables several monitoring functions.

### Maximum safety and protection

The CB series is designed to provide safe operation and long battery life. The following protections are standard features:

- Output protected against short circuit and overload
- High insulation between primary and secondary
- Protection against deep battery discharge
- Detection of batteries with wrong rated voltage
- Protection against reverse polarity connection
- Protection against the effect of parallel connection with other power sources, e.g. gensets.

All protections have automatic reset. No thermal fuse to be replaced.

### One device for all battery types

Completely automatic, the battery chargers of the CB series are microprocessor controlled devices suited to charging most batteries types thank to factory pre-set and selectable charging curves.

The can charge open lead acid, sealed lead acid, Bel and Ni-Cd, Ni-MH batteries. It is possible to change or add other charging curves connecting the device to a portable PC.

### Mutli-Stage charging Three charging modes

Automatic multi-stage operation and real time diagnostic allow fast recharge and recovery of deep discharged batteries, adding value and reliability to the system hosting the CB device. The type of charging it is Voltages stabilized and current stabilized IUoUo.

CB battery chargers feature three charging modes, identified by a flashing code on a LED.

- **Boost** (Boost-Bulk) (Blink 2/sec)
- **Trickle** (also known as float or maintenance charging) (Trickle - Float) (Blink 1/sec)
- **Recovery** (Recovery) (Blink 5/sec)

### Recovery charging

Automatic multi-stage operation optimizes and adapt to battery status, even when the battery voltage is very low. CB can recharge batteries even when their voltage is close to zero. It allows recharge and complete recovery of flat batteries.

#### Setting of battery maximum charging current

The maximum battery charging current can be set from 20% to 100% of the device rated value. Not available on LC models.

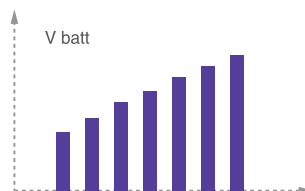

# CB Type Intelligent Battery Chargers

## Diagnostic of battery and device

All CB devices support the user during installation and operation. An LED flashing sequence code allows to discriminate among various possible faults.

### LED Diagnosis:

- **1 flash** Reverse polarity, wrong battery voltage.
- **2 flashes** Disconnected battery.
- **3 flashes** Battery element in short circuit.
- **5 flashes** Battery to be replaced (Internal impedance Bad or Bad battery wire connection.)

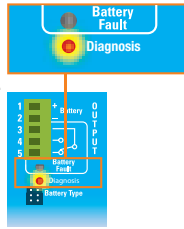

## Monitor signals

### Signal contracts

- CB chargers indicate battery status and faults also via a change-over contact with galvanic isolation.
- Battery common fault.
- Unit disconnected from mains.

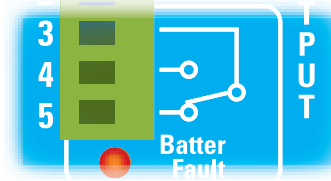

## Diagnostic checks

### Check for accidental disconnection of the battery cables

- If happen the devices switch off immediately the output power.

### Battery not connected

- If the battery it is not connected no output power.

### Test of quality wire connections

- During trickle charge the quality(resistance) on the battery connection is checked every 20 sec. this to detect if the cable connection has been properly made.

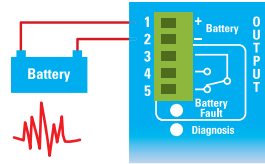

### Test of battery voltage connections

- Appropriate voltage check, to prevent connection of wrong battery types.

### End of charging check

- When the battery it is completely full, the device automatically switch in trickle charging mode.

### Reverse polarity check

- If the battery it is connected with inverted polarity, the devices are automatically protected.

### Visual indication

- Battery common fault
- Unit disconnected from mains
- Charging mode
- CV device self-diagnostic

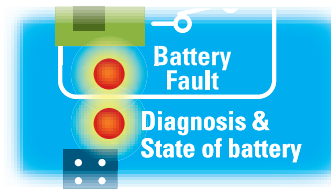

### Check for elements in short circuit

- Thanks to specific algorithms of evaluation, the CBs recognize batteries worth element in short circuit.

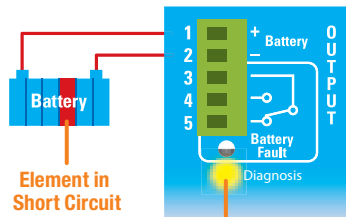

### Single output devices

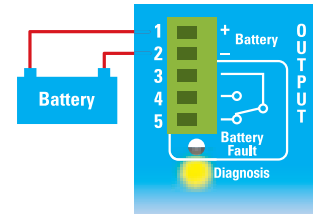

With the CB Battery Charger Line, Altech offers a highly reliable battery management solution. Operating at single phase Input Voltages of 115-230-277 VAC, the devices supply an Output of 12VDC and up to 35A or 24VDC and up to 20A.

Equipped with microcontrollers, the CB line offers fully automated multi-stage charging that will expand the battery's life significantly. Several diagnostic and monitoring features ensure easy handling and a high amount of transparency during daily operation.

Altech's CB line battery chargers are based on the switching technology which allows much higher efficiency as well as smaller and lighter devices. Additionally, several standard safety and protection features ensure safe installation and operation.

## Features:

- Fully automated charging
- Three charging modes
- Compact, rugged metal case
- Available in 12VDC and 24VDC
- Suitable for most common battery types
- Adjustable charging current
- Easy battery diagnosis and fault identification either by LED or external devices connected to fault status contacts
- High efficiency up to 91% through switching technology
- Several output protection features such as short circuit, overload, deep battery discharge etc.
- DIN rail mounting
- Small size
- 3 year warranty

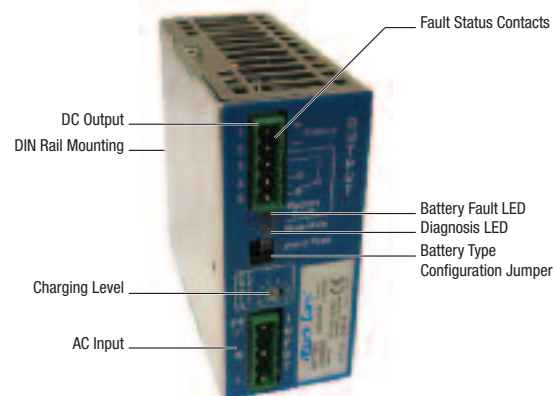

# CB Battery Chargers - Single Phase Specifications

Case 0



## 12V DC Single Phase DIN Rail Battery Charger

Cat. No.	Case	Input VAC	Output VDC	Output A	Recovery Charge VDC	Trickle Charge VDC	Boost Charge VDC	NOTES
CB123A	0	115-230-277	12	3	2-7	13.75	14.4	
CB126A*	0	115-230-277	12	6	2-7	13.75	14.4	
CB1210A	1	115-230-277	12	10	2-9	13.75	14.4	
CB1235A	3	115-230-277	12	35	2-9	13.75	14.4	

\* Not for new designs. See CB12245A for new design.

Case 1



## 24V DC Single Phase DIN Rail Battery Charger

Cat. No.	Case	Input VAC	Output VDC	Output A	Recovery Charge VDC	Trickle Charge VDC	Boost Charge VDC	NOTES
CB243A	0	115-230-277	24	3	2-16	27.5	28.8	
CB245A	1	115-230-277	24	5	2-18	27.5	28.8	
CB2410A	2	115-230-277	24	10	2-18	27.5	28.8	
CB2420A	3	115-230-277	24	20	2-18	27.5	28.8	

Case 2



## Multi Voltage Single Phase DIN Rail Battery Charger

Cat. No.	Case	Input VAC	Output VDC	Output A	Recovery Charge VDC	Trickle Charge VDC	Boost Charge VDC	NOTES
CB12245A	0	115-230-277	12/24	6/5	2-7/2-16	13.75/27.5	14.4/28.8	

Case 3



### Case Sizes

**Size 0:** 45 mm x 100 mm x 100 mm (1.78 x 3.94 x 3.94 in.)

**Size 1:** 65 mm x 115 mm x 135 mm (2.56 x 4.53 x 5.32 in.)

**Size 2:** 100 mm x 115 mm x 135 mm (3.94 x 4.53 x 5.32 in.)

**Size 3:** 150 mm x 115 mm x 135 mm (5.91 x 4.53 x 5.32 in.)

Output Current can be adjusted from 20%-100% of value given above.

# SPECIFICATIONS

## Case 0

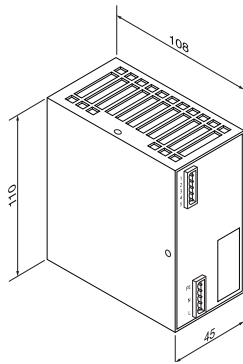

**Input Voltage**  
115-230 277VAC

**Input Current**  
0.5-0.3A (115-230VAC)

**Connection**  
Plugable screw terminal blocks

**Wire Range**  
0.2 - 2.5mm<sup>2</sup> / AWG 24-14

**Size (WxHxD)**  
45x110x100 mm  
(1.78 x 3.94 x 3.94 in.)

**Packaging**  
1/box; 0.30kg (0.66 lbs)

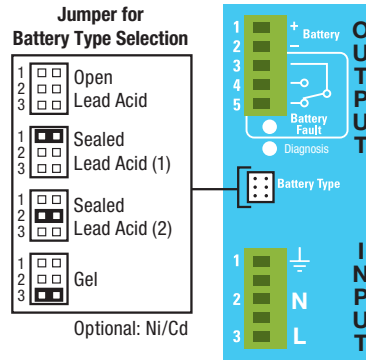

## Case 1

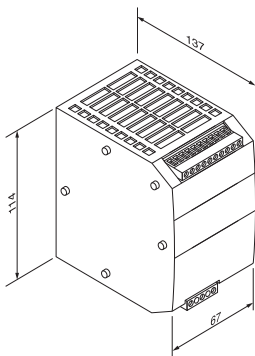

**Input Voltage**  
115-230 277VAC

**Input Current**  
2.4-1.2A (115-230VAC)

**Connection**  
Screw terminal blocks

**Wire Range**  
0.2 - 2.5mm<sup>2</sup> / AWG 24-14

**Size (WxHxD)**  
65x115x135 mm  
(2.56 x 4.53 x 5.32 in.)

**Packaging**  
1/box; 0.65kg (1.43 lbs)

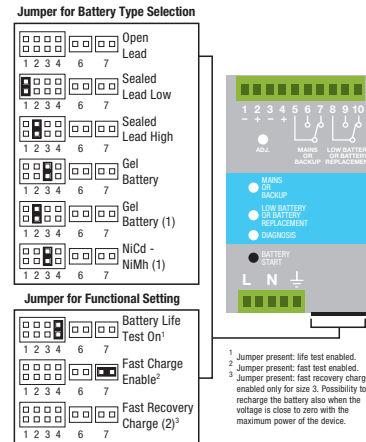

## Case 2

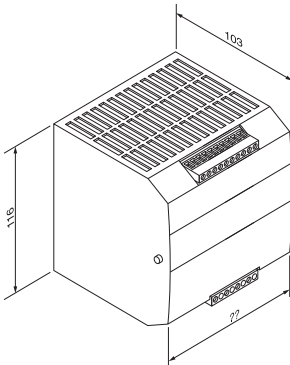

**Input Voltage**  
115-230 277VAC

**Input Current**  
3.3-2.2A (115-230VAC)

**Connection**  
Screw terminal blocks

**Wire Range**  
0.2 - 2.5mm<sup>2</sup> / AWG 24-14

**Size (WxHxD)**  
100x115x135 mm  
(3.94 x 4.53 x 5.32 in.)

**Packaging**  
1/box; 0.85kg (1.87 lbs)

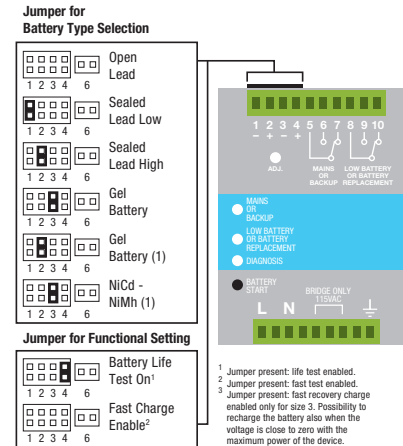

## Case 3

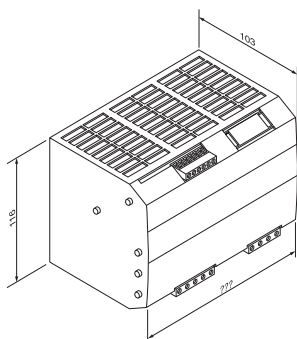

**Input Voltage**  
115-230 277VAC

**Input Current**  
8-4.2A (115-230VAC)

**Connection**  
screw terminal blocks

**Wire Range**  
0.2 - 4mm<sup>2</sup> / AWG 30-10

**Size (WxHxD)**  
150x115x135 mm  
(5.91 x 4.53 x 5.32 in.)

**Packaging**  
1/box; 1.5kg (3.31 lbs)

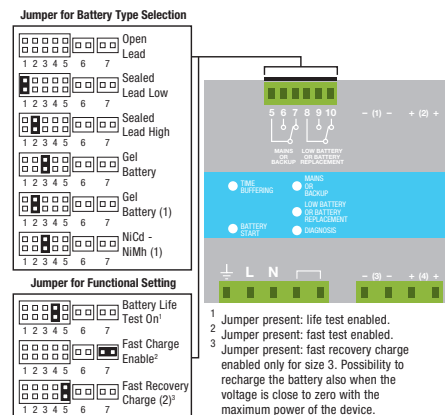



# CB123A Battery Charger



## Features:

- Input: Single-phase 115 - 230 - 277 VAC
- Output: Battery charging 12 VDC; 3 A
- Suited for the following battery types: Open Lead Acid, Sealed Lead Acid, lead Gel and Ni-Cd (option)
- Automatic diagnostic of battery status. Charging curve IUoUo, constant voltage and current
- Switching technology, output voltage 14.4 VDC
- Three charging levels: Boost, Trickle, Recovery.
- Protected against short circuit, inverted polarity, over load.
- Signal output (contact free) for fault battery state
- Protection degree IP20 - DIN rail mountable

## INPUT

## BATTERY OUTPUT

## GENERAL DATA

## ENVIRONMENT

## SAFETY & EMC

## OTHERS

Cat. No.	CB123A
<b>Input Data</b> Nominal Input Voltage (2 x VAC) Input Voltage range (VAC) Inrush Current (Vn and In Load) I2t Frequency Input Current Internal Fuse External Fuse (recommended)	115 ~ 230 ~ 277 VAC 90 ~ 305 VAC 11 A ≤ 5 msec. 47 ~ 63 Hz ±6% 0.5 A ~ 115 VAC; 0.3A ~ 230 VAC 4 A 10 A (MCB curve B)
<b>Battery Output (Battery Care)</b> Boost charge (25°C) (typ. at In) Max. time Bust Charge (typ. at In) Min. time Bust Charge (typ. at In) Trickle charge (25°C) (typ. at In) Recovery Charge Charging. Max Ibatt (In) Adjustable charging current Iadj (% In) Efficiency (50% - In) Quiescent Current Charging Curve automatic: IUoUo Detection of element in short circuit Short-circuit protection Over Load protection Over Voltage Output protection Jumper Configuration battery type (V cell) Ni-Cd (optional)	14.4 VDC 15 h 70 min. 13.75 VDC 2 ~ 7 VDC 3 A ±5% 20 – 100 81% ≤5 mA 3 stage Yes Yes Yes Yes 2,23;2,25;2,27;2,3; 1,41–1,5 (20 elem.)
<b>General Data</b> Insulation voltage (In /Out) Insulation voltage (In / PE) Insulation voltage (Out / PE) Protection Class (EN/IEC 60529) Protection class Reliability: MTBF IEC 61709 Pollution Degree Environment Connection Terminal Blocks screw Type Dimensions (W-H-D) Weight	3000 VAC 1605 VAC 500 VAC IP20 I, with PE connected > 300.000 hours 2 2,5mm (24~14AWG) 45x100x100 mm (1.78 x 3.94 x 3.94 in.) 0.30 Kg approx. (0.65 lbs.)
<b>Climate Data</b> Ambient temperature (operation) De Rating Ta > 50°C Ambient temperature Storage Humidity at 25°C no condensation Cooling	-25 - +70°C (-13~158°F) -2.5%(In) / °C -40 – +85°C (-40~185°F) 95% to 25°C Auto Convection
<b>Norms and Certifications</b> Conforming to:	IEC/EN 60335-2-29,EN60950/UL1950, Electrical safety, 89/336/EEC, EMC Directive, 2006/95/EC (Low Voltage), DIN41773 (Charging cycle), Emission:IEC 61000-6-4,Immunity: IEC 61000-6-2.CE
<b>Signal Output (free switch contact)</b> Main or Backup Power Low Battery Fault Battery	Yes Yes Yes
<b>Type of Signal Output Contact</b> Max. current can be switched (EN60947.4.1): Max. DC1: 30 VDC 1 A; AC1: 60 VAC 1A Min.1mA at 5 VDC	Resistive load Min load

# CB123A Battery Charger

## Technical Features

The CB series battery chargers are designed with advanced multi-stage battery charging method, completely automatic and suited to meet the most advanced requirements of battery manufacturers. The Battery Care concept is based on algorithms that implement rapid and automatic charging, battery charge optimization during time, flat batteries recovery and real time diagnostic during installation and operation. The Real Time Autodiagnostic system, monitoring battery faults such as, elements in short circuit, accidental reverse polarity connection, disconnection of the battery, they can easily be detected and removed by help of Blink Code of Diagnosis Led; during the installation and after sell. Each device is suited for all battery types, by means of jumpers it is possible setting predefined curves for Open Lead Acid, Sealed Lead Acid, Gel, Ni-Cd(option). They are programmed for two charging levels, boost and trickle. A rugged casing with bracket for DIN rail mounting provide IP20 protection degree. They are extremely compact and cost-effective.

## Charging

Automatic multi-stage charging and real time diagnostic allow fast recharge and recovery of deep discharged batteries, adding value and reliability to the system hosting. Type of charging is Voltages and current stabilized IUoUo. The state of charging battery and Autodiagnosis of the systems are identified by a flashing code on a Diagnosis LED and Fault Battery LED:

	State	Diagnosis LED	Battery Fault LED
Charging Type	Trickle	1 Blink/sec	OFF
	Boost	2 Blink/sec	OFF
	Recovery	5 Blink/sec	OFF
Auto diagnosis	Reverse polarity	⎓ 1 Blink	ON
	Battery No connect	⎓ 2 Blink	ON
	Element in Short C.	⎓ 3 Blink	ON
	Replace Battery	⎓ 5 Blink	ON

## Wiring Terminals and Jumper Settings

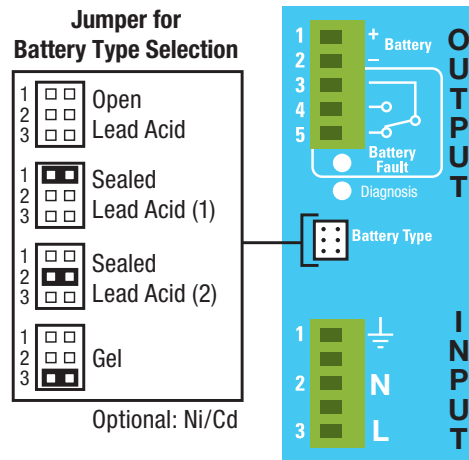

## Wiring Diagram

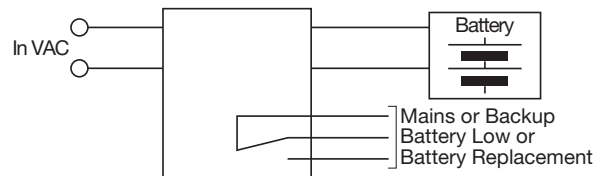

## CB Charging Diagram

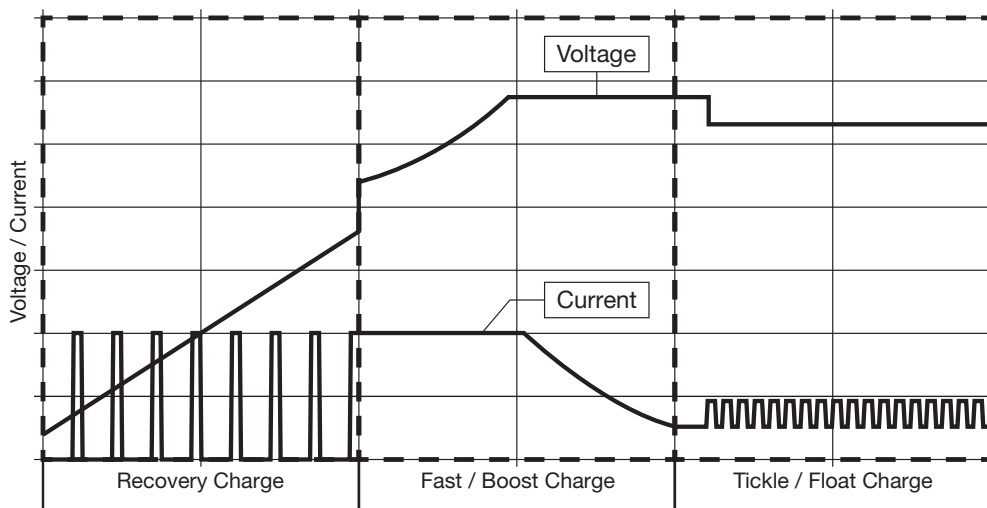





# CB126A Battery Charger



**\* Not for new designs.**

## Features:

- Input: Single-phase 115 - 230 - 277 VAC
- Output: Battery charging 12 VDC; 6 A
- Suited for the following battery types: Open Lead Acid, Sealed Lead Acid, lead Gel and Ni-Cd (option)
- Automatic diagnostic of battery status. Charging curve IUoUo, constant voltage and current
- Switching technology, output voltage 14.4 VDC
- Three charging levels: Boost, Trickle, Recovery.
- Protected against short circuit, inverted polarity, over load.
- Signal output (contact free) for fault battery state
- Protection degree IP20 - DIN rail mountable.

## INPUT

## BATTERY OUTPUT

## GENERAL DATA

## ENVIRONMENT

## SAFETY & EMC

## OTHERS

Cat. No.	CB126A
<b>Input Data</b> Nominal Input Voltage (2 x VAC) Input Voltage range (VAC) Inrush Current (Vn and In Load) I2t Frequency Input Current Internal Fuse External Fuse (recommended)	115 ~ 230 ~ 277 VAC 90 ~ 305 VAC $\leq 11 \text{ A} \leq 5 \text{ msec.}$ 47 ~ 63 Hz $\pm 6\%$ 1 A ~ 115 VAC; 0.7 A 230 VAC 4 A 10 A (MCB curve B)
<b>Battery Output (Battery Care)</b> Boost charge (25°C) (typ. at $I_n$ ) Max. time Bust Charge (tpy. at $I_n$ ) Min. time Bust Charge (tpy. at $I_n$ ) Trickle charge (25°C) (typ. at $I_n$ ) Recovery Charge Charging. Max $I_{batt} < 40^\circ\text{C}$ ( $I_n$ ) Charging. Max $I_{batt} > 40^\circ\text{C}$ ( $I_n$ ) Efficiency (50% - $I_n$ ) Charging current limiting $I_{adj}$ Quiescent Current Charging Curve automatic: IUoUo Detection of element in short circuit Short-circuit protection Over Load protection Over Voltage Output protection Jumper Configuration battery type (V cell) Ni-Cd (optional)	14.4 VDC 15 h 70 min. 13.75 VDC 2 ~ 7 VDC 6 A $\pm 5\%$ 4 A 81% 20 – 100 % $I_n$ $\leq 5 \text{ mA}$ 3 stage Yes Yes Yes Yes 2,23;2,25;2,27;2,3; 1,41–1,5 (20 elem.)
<b>General Data</b> Insulation voltage (In /Out) Insulation voltage (In / PE) Insulation voltage (Out / PE) Protection Class (EN/IEC 60529) Protection class Reliability: MTBF IEC 61709 Pollution Degree Environment Connection Terminal Blocks screw Type Dimensions (W-H-D) Weight	3000 VAC 1605 VAC 500 VAC IP20 I, with PE connected > 300.000 hours 2 2,5mm (24~14AWG) 45x100x100 mm (1.78 x 3.94 x 3.94 in.) 0.30 Kg approx. (0.65 lbs.)
<b>Climate Data</b> Ambient temperature (operation) De Rating $T_a > 50^\circ\text{C}$ Ambient temperature Storage Humidity at 25°C no condensation Cooling	-25 - +70°C (-13~158°F) - 2.5%( $I_n$ ) / °C -40 - +85°C (-40~185°F) 95% to 25°C Auto Convention
<b>Norms and Certifications</b> Conforming to:	IEC/EN 60335-2-29,EN60950/UL1950, Electrical safety, 89/336/EEC, EMC Directive, 2006/95/EC (Low Voltage), DIN41773 (Charging cycle), Emission:IEC 61000-6-4,Immunity: IEC 61000-6-2.CE
<b>Signal Output (free switch contact)</b> Main or Backup Power Low Battery Fault Battery	Yes Yes Yes
<b>Type of Signal Output Contact</b> Max. current can be switched (EN60947.4.1): Max. DC1: 30 VDC 1 A; AC1: 60 VAC 1A Min.1mA at 5 VDC	Resistive load Min load



# CB126A Battery Charger

**\* Not for new designs.**

## Technical Features

The CB series battery chargers are designed with advanced multi-stage battery charging method, completely automatic and suited to meet the most advanced requirements of battery manufacturers. The Battery Care concept is based on algorithms that implement rapid and automatic charging, battery charge optimization during time, flat batteries recovery and real time diagnostic during installation and operation. The Real Time Autodiagnostic system, monitoring battery faults such as, elements in short circuit, accidental reverse polarity connection, disconnection of the battery, they can easily be detected and removed by help of Blink Code of Diagnosis Led; during the installation and after sell. Each device is suited for all battery types, by means of jumpers it is possible setting predefined curves for Open Lead Acid, Sealed Lead Acid, Gel, Ni-Cd(option). They are programmed for two charging levels, boost and trickle. A rugged casing with bracket for DIN rail mounting provide IP20 protection degree. They are extremely compact and cost-effective.

## Charging

Automatic multi-stage charging and real time diagnostic allow fast recharge and recovery of deep discharged batteries, adding value and reliability to the system hosting. Type of charging is Voltages and current stabilized IUoUo. The state of charging battery and Autodiagnosis of the systems are identified by a flashing code on a Diagnosis LED and Fault Battery LED:

	State	Diagnosis LED	Battery Fault LED
Charging Type	Trickle	1 Blink/sec	OFF
	Boost	2 Blink/sec	OFF
	Recovery	5 Blink/sec	OFF
Auto diagnosis	Reverse polarity	1 Blink	ON
	Battery No connect	2 Blink	ON
	Element in Short C.	3 Blink	ON
	Replace Battery	5 Blink	ON

## Wiring Terminals and Jumper Settings

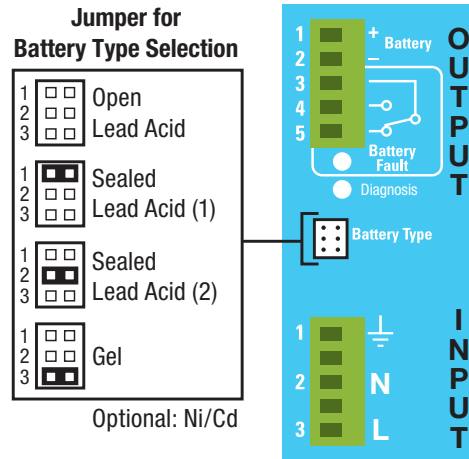

## Wiring Diagram

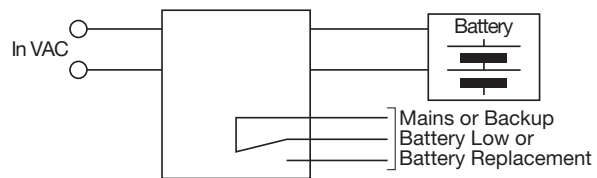

## CB Charging Diagram

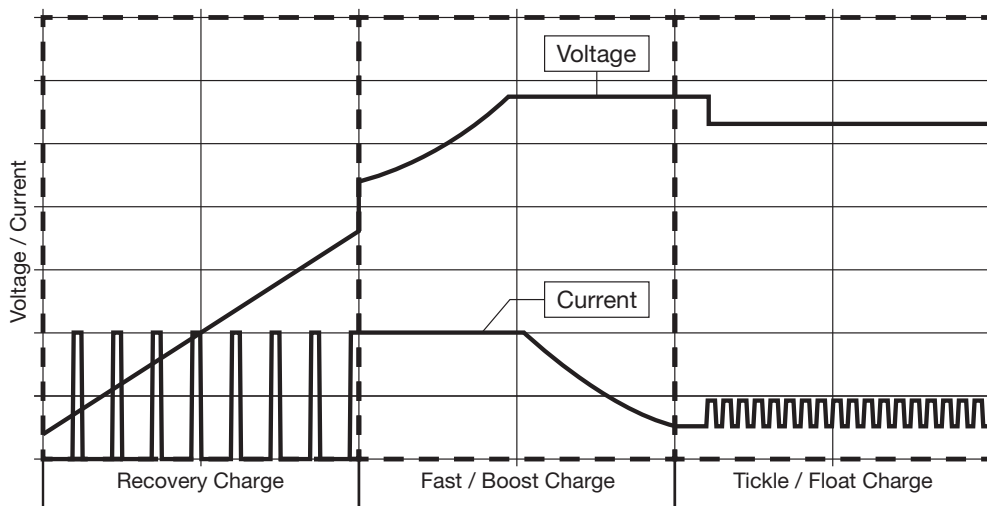



# CB1210A Battery Charger



## Features:

- Input: Single-phase 115 - 230 - 277 VAC
- Output: Battery charging 12 VDC; 10 A
- Suited for the following battery types: Open Lead Acid, Sealed Lead Acid, lead Gel and Ni-Cd (option)
- Automatic diagnostic of battery status. Charging curve I<sub>UoUo</sub>, constant voltage and current
- Switching technology, output voltage 14.4 VDC
- Three charging levels: Boost, Trickle, Recovery.
- Protected against short circuit, inverted polarity, over load.
- Signal output (contact free) for fault battery state
- Protection degree IP20 - DIN rail mountable

## INPUT

## BATTERY OUTPUT

## GENERAL DATA

## ENVIRONMENT

## SAFETY & EMC

## OTHERS

### Cat. No.

### CB1210A

<b>Input Data</b> Nominal Input Voltage (2 x VAC) Input Voltage range (VAC) Inrush Current (Vn and In Load) I <sub>2t</sub> Frequency Input Current Internal Fuse External Fuse (recommended)	115 ~ 230 ~ 277 VAC 90 ~ 305 VAC $\leq 16 \text{ A} \leq 5 \text{ msec.}$ 47 ~ 63 Hz $\pm 6\%$ 2.4 A ~ 115 VAC; 1.2 A 230 VAC 4 A 10 A (MCB curve B)
<b>Battery Output (Battery Care)</b> Boost charge (25°C) (typ. at I <sub>n</sub> ) Max. time Bust Charge (tpy. at I <sub>n</sub> ) Min. time Bust Charge (tpy. at I <sub>n</sub> ) Trickle charge (25°C) (typ. at I <sub>n</sub> ) Recovery Charge Charging. Max I <sub>batt</sub> (I <sub>n</sub> ) Efficiency (50% - I <sub>n</sub> ) Charging current limiting I <sub>adj</sub> Quiescent Current Charging Curve automatic: I <sub>UoUo</sub> Detection of element in short circuit Short-circuit protection Over Load protection Over Voltage Output protection Jumper Configuration battery type (V cell) Ni-Cd (optional)	14.4 VDC 15 h 1 min. 13.75 VDC 2 ~ 9 VDC 10 A $\pm 5\%$ 89% 20 - 100 % I <sub>n</sub> $\leq 5 \text{ mA}$ 3 stage Yes Yes Yes Yes 2,23;2,25;2,27;2,3; 1,41-1,5 (20 elem.)
<b>General Data</b> Insulation voltage (In /Out) Insulation voltage (In / PE) Insulation voltage (Out / PE) Protection Class (EN/IEC 60529) Protection class Reliability: MTBF IEC 61709 Pollution Degree Environment Connection Terminal Blocks screw Type Dimensions (W-H-D) Weight	3000 VAC 1605 VAC 500 VAC IP20 I, with PE connected > 300.000 hours 2 2,5mm(24-14AWG) 65x115x135 mm (2.56 x 4.53 x 5.32 in.) 0.65 Kg approx. (1.43 lbs.)
<b>Climate Data</b> Ambient temperature (operation) De Rating Ta > 50°C Ambient temperature Storage Humidity at 25°C no condensation Cooling	-25 - +70°C (-13~158°F) - 2.5%(In) / °C -40 - +85°C (-40~185°F) 95% to 25°C Auto Convention
<b>Norms and Certifications</b> Conforming to:	IEC/EN 60335-2-29,EN60950/UL1950, Electrical safety, 89/336/EEC, EMC Directive, 2006/95/EC (Low Voltage), DIN41773 (Charging cycle), Emission:IEC 61000-6-4,Immunity: IEC 61000-6-2.CE
<b>Signal Output (free switch contact)</b> Main or Backup Power Low Battery Fault Battery	Yes Yes Yes
<b>Type of Signal Output Contact</b> Max. current can be switched (EN60947.4.1): Max. DC1: 30 VDC 1 A; AC1: 60 VAC 1A Min.1mA at 5 VDC	Resistive load Min load

# CB1210A Battery Charger

## Technical Features

The CB series battery chargers are designed with advanced multi-stage battery charging method, completely automatic and suited to meet the most advanced requirements of battery manufacturers. The Battery Care concept is based on algorithms that implement rapid and automatic charging, battery charge optimization during time, flat batteries recovery and real time diagnostic during installation and operation. The Real Time Autodiagnostic system, monitoring battery faults such as, elements in short circuit, accidental reverse polarity connection, disconnection of the battery, they can easily be detected and removed by help of Blink Code of Diagnosis Led; during the installation and after sell. Each device is suited for all battery types, by means of jumpers it is possible setting predefined curves for Open Lead Acid, Sealed Lead Acid, Gel, Ni-Cd(option). They are programmed for two charging levels, boost and trickle. A rugged casing with bracket for DIN rail mounting provide IP20 protection degree. They are extremely compact and cost-effective.

## Charging

Automatic multi-stage charging and real time diagnostic allow fast recharge and recovery of deep discharged batteries, adding value and reliability to the system hosting. Type of charging is Voltages and current stabilized IUoUo. The state of charging battery and Autodiagnosis of the systems are identified by a flashing code on a Diagnosis LED and Fault Battery LED:

	State	Diagnosis LED	Battery Fault LED
Charging Type	Trickle	1 Blink/sec	OFF
	Boost	2 Blink/sec	OFF
	Recovery	5 Blink/sec	OFF
Auto diagnosis	Reverse polarity	1 Blink	ON
	Battery No connect	2 Blink	ON
	Element in Short C.	3 Blink	ON
	Replace Battery	5 Blink	ON

## Jumper for Battery Type Selection

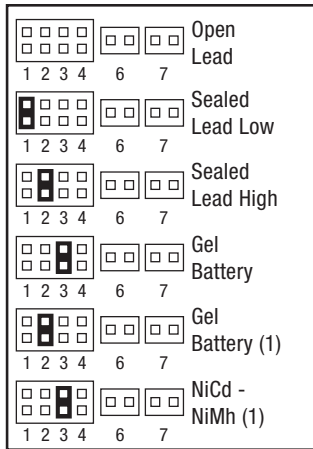

## Jumper for Functional Setting

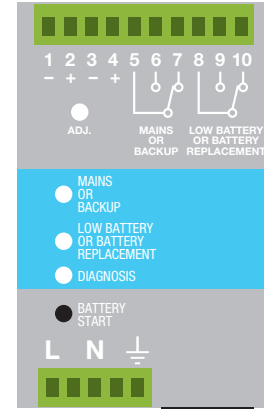
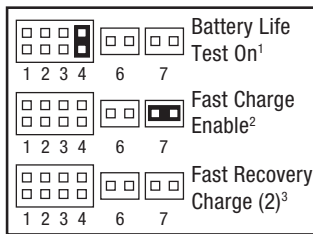

- 1 Jumper present: life test enabled.
- 2 Jumper present: fast test enabled.
- 3 Jumper present: fast recovery charge enabled only for size 3. Possibility to recharge the battery also when the voltage is close to zero with the maximum power of the device.

## Wiring Diagram

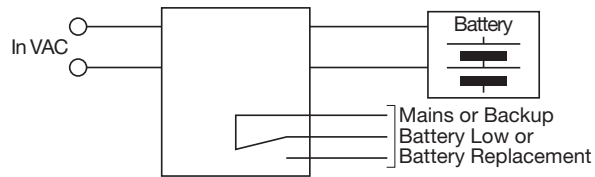

## CB Charging Diagram

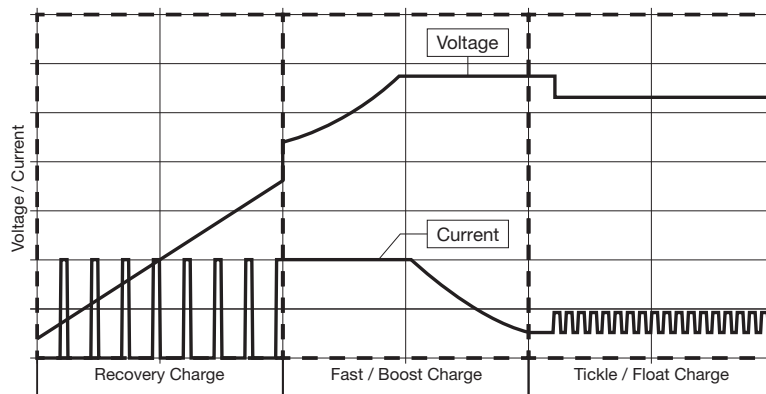



# CB1235A Battery Charger



## Features:

- Input: Single-phase 115 - 230 - 277 VAC
- Output: Battery charging 24 VDC; 35 A
- Suited for the following battery types: Open Lead Acid, Sealed Lead Acid, lead Gel and Ni-Cd (option)
- Automatic diagnostic of battery status. Charging curve I<sub>UoUo</sub>, constant voltage and current
- Switching technology, output voltage 28.8 VDC
- Three charging levels: Boost, Trickle, Recovery.
- Protected against short circuit, inverted polarity, over load.
- Signal output (contact free) for fault battery state
- Protection degree IP20 - DIN rail mountable

## INPUT

## BATTERY OUTPUT

## GENERAL DATA

## ENVIRONMENT

## SAFETY & EMC

## OTHERS

Cat. No.	CB1235A
<b>Input Data</b> Nominal Input Voltage (2 x VAC) Input Voltage range (VAC) Inrush Current (Vn and In Load) I <sup>2</sup> t Frequency Input Current Internal Fuse External Fuse (recommended)	115 / 230 ~ 277 VAC 90 ~ 135 / 180 ~ 305 VAC ≤ 35 A ≤ 5 msec. 47 ~ 63 Hz ±6% 1.0 A ~ 115 VAC; 0.7 A 230 VAC 10 A 16 A (MCB curve B)
<b>Battery Output (Battery Care)</b> Boost charge (25°C) (typ. at I <sub>n</sub> ) Max. time Bust Charge (typ. at I <sub>n</sub> ) Min. time Bust Charge (typ. at I <sub>n</sub> ) Trickle charge (25°C) (typ. at I <sub>n</sub> ) Recovery Charge Charging. Max I <sub>batt</sub> (I <sub>n</sub> ) Efficiency (50% - I <sub>n</sub> ) Charging current limiting I <sub>adj</sub> Quiescent Current Charging Curve automatic: I <sub>UoUo</sub> Detection of element in short circuit Short-circuit protection Over Load protection Over Voltage Output protection Power Supply Mode Jumper Configuration battery type (V cell) Ni-Cd (optional)	14.4 VDC 15 h 1 min. 13.75 VDC 2 ~ 9 VDC 35 A ±5% 91% 20 – 100 % I <sub>n</sub> ≤5 mA 3 stage Yes Yes Yes Yes Yes 2,23;2,25;2,27;2,3; 1,41–1,5 (20 elem.)
<b>General Data</b> Insulation voltage (In /Out) Insulation voltage (In / PE) Insulation voltage (Out / PE) Protection Class (EN/IEC 60529) Protection class Reliability: MTBF IEC 61709 Pollution Degree Environment Connection Terminal Blocks screw Type Dimensions (W-H-D) Weight	3000 VAC 1605 VAC 500 VAC IP20 I, with PE connected > 300.000 hours 2 4mm(30–10AWG) 150x115x135 mm (5.91 x 4.53 x 5.32 in.) 1.5 Kg approx. (3.31 lbs.)
<b>Climate Data</b> Ambient temperature (operation) De Rating Ta > 50°C Ambient temperature Storage Humidity at 25°C no condensation Cooling	-25 - +70°C (-13~158°F) - 2.5%(In) / °C -40 – +85°C (-40~185°F) 95% to 25°C Auto Convection
<b>Norms and Certifications</b> Conforming to:	IEC/EN 60335-2-29,EN60950/UL1950, Electrical safety, 89/336/EEC, EMC Directive, 2006/95/EC (Low Voltage),DIN41773 (Charging cycle), Emission:IEC 61000-6-4,Immunity: IEC 61000-6-2.CE
<b>Signal Output (free switch contact)</b> Main or Backup Power Low Battery Fault Battery	Yes Yes Yes
<b>Type of Signal Output Contact</b> Max. current can be switched (EN60947.4.1): Max. DC1: 30 VDC 1 A; AC1: 60 VAC 1A Min.1mA at 5 VDC	Resistive load Min load

# CB1235A Battery Charger

## Technical Features

The CB series battery chargers are designed with advanced multi-stage battery charging method, completely automatic and suited to meet the most advanced requirements of battery manufacturers. The Battery Care concept is based on algorithms that implement rapid and automatic charging, battery charge optimization during time, flat batteries recovery and real time diagnostic during installation and operation. The Real Time Autodiagnostic system, monitoring battery faults such as, elements in short circuit, accidental reverse polarity connection, disconnection of the battery, they can easily be detected and removed by help of Blink Code of Diagnosis Led; during the installation and after sell. Each device is suited for all battery types, by means of jumpers it is possible setting predefined curves for Open Lead Acid, Sealed Lead Acid, Gel, Ni-Cd(option). They are programmed for two charging levels, boost and trickle. A rugged casing with bracket for DIN rail mounting provide IP20 protection degree. They are extremely compact and cost-effective.

## Charging

Automatic multi-stage charging and real time diagnostic allow fast recharge and recovery of deep discharged batteries, adding value and reliability to the system hosting. Type of charging is Voltages and current stabilized IUoUo. The state of charging battery and Autodiagnosis of the systems are identified by a flashing code on a Diagnosis LED and Fault Battery LED:

	State	Diagnosis LED	Battery Fault LED
Charging Type	Trickle	1 Blink/sec	OFF
	Boost	2 Blink/sec	OFF
	Recovery	5 Blink/sec	OFF
Auto diagnosis	Reverse polarity	1 Blink	ON
	Battery No connect	2 Blink	ON
	Element in Short C.	3 Blink	ON
	Replace Battery	5 Blink	ON

### Jumper for Battery Type Selection

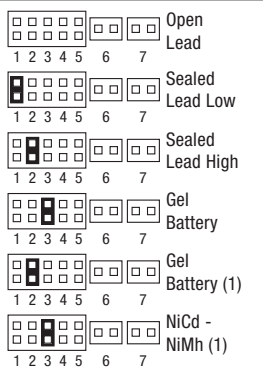

### Jumper for Functional Setting

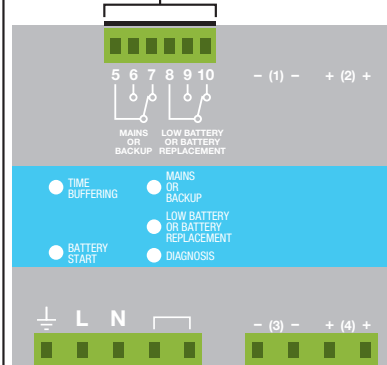
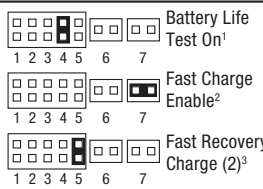

- 1 Jumper present: life test enabled.
- 2 Jumper present: fast test enabled.
- 3 Jumper present: fast recovery charge enabled only for size 3. Possibility to recharge the battery also when the voltage is close to zero with the maximum power of the device.

## Wiring Diagram

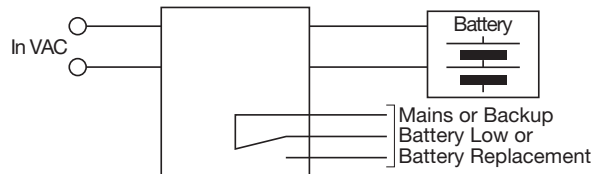

## CB Charging Diagram

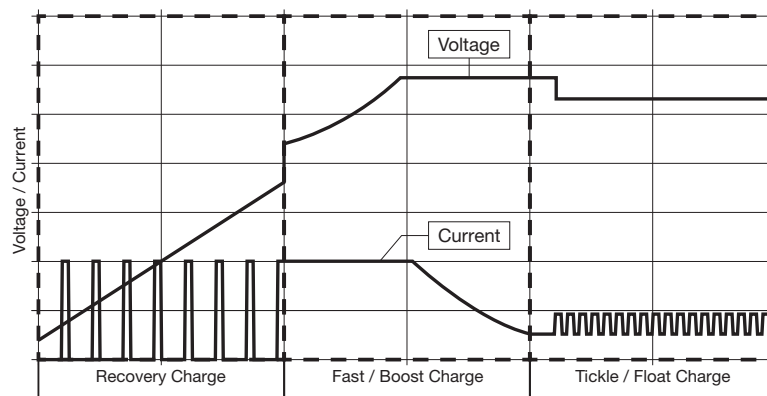



# CB243A Battery Charger



## Features:

- Input: Single-phase 115 - 230 - 277 VAC
- Output: Battery charging 24 VDC; 3 A
- Suited for the following battery types: Open Lead Acid, Sealed Lead Acid, lead Gel and Ni-Cd (option)
- Automatic diagnostic of battery status. Charging curve IUoUo, constant voltage and current
- Switching technology, output voltage 28.8 VDC
- Three charging levels: Boost, Trickle, Recovery.
- Protected against short circuit, inverted polarity, over load.
- Signal output (contact free) for fault battery state
- Protection degree IP20 - DIN rail mountable

## INPUT

## BATTERY OUTPUT

## GENERAL DATA

## ENVIRONMENT

## SAFETY & EMC

## OTHERS

Cat. No.	CB243A
<b>Input Data</b> Nominal Input Voltage (2 x VAC) Input Voltage range (VAC) Inrush Current (Vn and In Load) I2t Frequency Input Current Internal Fuse External Fuse (recommended)	115 ~ 230 ~ 277 VAC 90 ~ 305 VAC $\leq 7 \text{ A} \leq 5 \text{ msec.}$ 47 ~ 63 Hz $\pm 6\%$ (115 ~ 230 VAC) 1 ~ 0.7 A 4 A 10 A (MCB curve B)
<b>Battery Output (Battery Care)</b> Boost charge (25°C) (typ. at In) Max. time Bust Charge (tpy. at In) Min. time Bust Charge (tpy. at In) Trickle charge (25°C) (typ. at In) Recovery Charge Charging. Max Ibatt (In) Adjustable charging current Iadj (% In) Efficiency (50% - In) Quiescent Current Charging Curve automatic: IUoUo Detection of element in short circuit Short-circuit protection Over Load protection Over Voltage Output protection Jumper Configuration battery type (V cell) Ni-Cd (optional)	28.8 VDC 15 h 70 min. 27.5 VDC 2 ~ 16 VDC 3 A $\pm 5\%$ 20 - 100 81% $\leq 5 \text{ mA}$ 3 stage Yes Yes Yes Yes 2,23;2,25;2,27;2,3; 1,41-1,5 (20 elem.)
<b>General Data</b> Insulation voltage (In /Out) Insulation voltage (In / PE) Insulation voltage (Out / PE) Protection Class (EN/IEC 60529) Protection class Reliability: MTBF IEC 61709 Pollution Degree Environment Connection Terminal Blocks screw Type Dimensions (W-H-D) Weight	3000 VAC 1605 VAC 500 VAC IP20 I, with PE connected > 300.000 hours 2 2,5mm(24-14AWG) 45x100x100 mm (1.78 x 3.94 x 3.94 in.) 0.30 Kg approx. (0.66 lbs.)
<b>Climate Data</b> Ambient temperature (operation) De Rating Ta > 50°C Ambient temperature Storage Humidity at 25°C no condensation Cooling	-25 - +70°C (-13~158°F) - 2.5%(In) / °C -40 - +85°C (-40~185°F) 95% to 25°C Auto Convection
<b>Norms and Certifications</b> Conforming to:	IEC/EN 60335-2-29,EN60950/UL1950, Electrical safety, 89/336/EEC, EMC Directive, 2006/95/EC (Low Voltage),DIN41773 (Charging cycle), Emission:IEC 61000-6-4,Immunity: IEC 61000-6-2.CE
<b>Signal Output (free switch contact)</b> Main or Backup Power Low Battery Fault Battery	Yes Yes Yes
<b>Type of Signal Output Contact</b> Max. current can be switched (EN60947.4.1): Max. DC1: 30 VDC 1 A; AC1: 60 VAC 1A Min.1mA at 5 VDC	Resistive load Min load



# CB243A Battery Charger

## Technical Features

The CB series battery chargers are designed with advanced multi-stage battery charging method, completely automatic and suited to meet the most advanced requirements of battery manufacturers. The Battery Care concept is based on algorithms that implement rapid and automatic charging, battery charge optimization during time, flat batteries recovery and real time diagnostic during installation and operation. The Real Time Autodiagnostic system, monitoring battery faults such as, elements in short circuit, accidental reverse polarity connection, disconnection of the battery, they can easily be detected and removed by help of Blink Code of Diagnosis Led; during the installation and after sell. Each device is suited for all battery types, by means of jumpers it is possible setting predefined curves for Open Lead Acid, Sealed Lead Acid, Gel, Ni-Cd(option). They are programmed for two charging levels, boost and trickle. A rugged casing with bracket for DIN rail mounting provide IP20 protection degree. They are extremely compact and cost-effective.

## Charging

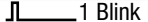
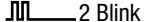
Automatic multi-stage charging and real time diagnostic allow fast recharge and recovery of deep discharged batteries, adding value and reliability to the system hosting. Type of charging is Voltages and current stabilized IUoUo. The state of charging battery and Autodiagnosis of the systems are identified by a flashing code on a Diagnosis LED and Fault Battery LED:

	State	Diagnosis LED	Battery Fault LED
Charging Type	Trickle	1 Blink/sec	OFF
	Boost	2 Blink/sec	OFF
	Recovery	5 Blink/sec	OFF
Auto diagnosis	Reverse polarity	 1 Blink	ON
	Battery No connect	 2 Blink	ON
	Element in Short C.	 3 Blink	ON
	Replace Battery	 5 Blink	ON

## Wiring Terminals and Jumper Settings

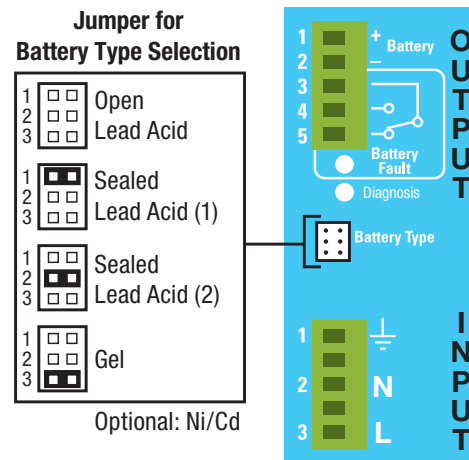

## Wiring Diagram

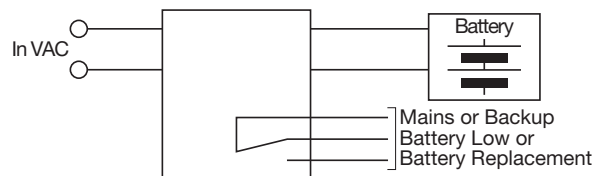

## CB Charging Diagram

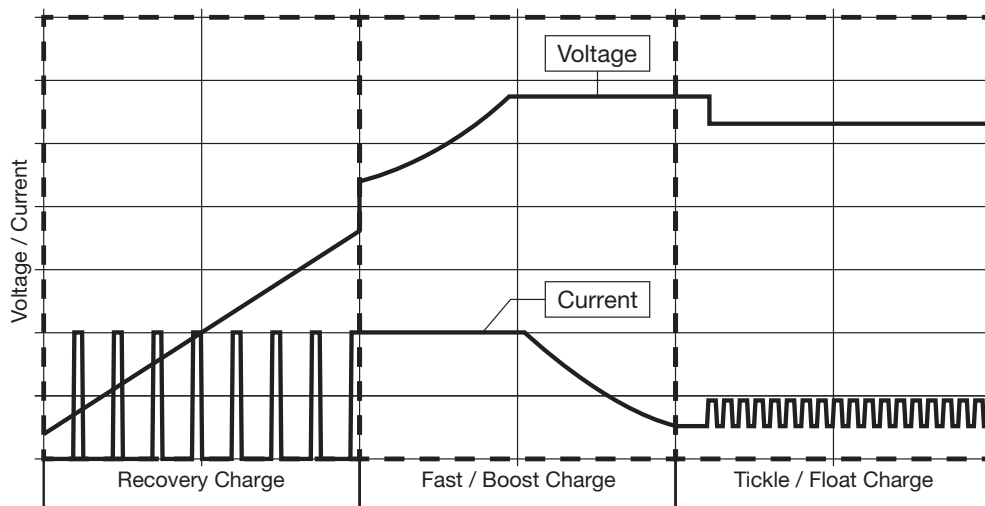





# CB245A Battery Charger



## Features:

- Input: Single-phase 115 - 230 - 277 VAC
- Output: Battery charging 24 VDC; 5 A
- Suited for the following battery types: Open Lead Acid, Sealed Lead Acid, lead Gel and Ni-Cd (option)
- Automatic diagnostic of battery status. Charging curve IUoUo, constant voltage and current
- Switching technology, output voltage 28.8 VDC
- Three charging levels: Boost, Trickle, Recovery.
- Protected against short circuit, inverted polarity, over load.
- Signal output (contact free) for fault battery state
- Protection degree IP20 - DIN rail mountable

## INPUT

## BATTERY OUTPUT

## GENERAL DATA

## ENVIRONMENT

## SAFETY & EMC

## OTHERS

Cat. No.	CB245A
<b>Input Data</b> Nominal Input Voltage (2 x VAC) Input Voltage range (VAC) Inrush Current (Vn and In Load) I <sup>2</sup> t Frequency Input Current Internal Fuse External Fuse (recommended)	115 ~ 230 ~ 277 VAC 90 ~ 305 VAC ≤ 16 A ≤ 5 msec. 47 ~ 63 Hz ±6% 3.3 A - 115 VAC; 2.2 A ~ 2300 AC 4 A 10 A (MCB curve B)
<b>Battery Output (Battery Care)</b> Boost charge (25°C) (typ. at I <sub>n</sub> ) Max. time Bust Charge (typ. at I <sub>n</sub> ) Min. time Bust Charge (typ. at I <sub>n</sub> ) Trickle charge (25°C) (typ. at I <sub>n</sub> ) Recovery Charge Charging. Max I <sub>batt</sub> (I <sub>n</sub> ) Efficiency (50% - I <sub>n</sub> ) Charging current limiting I <sub>adj</sub> Quiescent Current Charging Curve automatic: IUoUo Detection of element in short circuit Short-circuit protection Over Load protection Over Voltage Output protection Jumper Configuration battery type (V cell) Ni-Cd (optional)	28.8 VDC 15 h 1 min. 27.5 VDC 2 ~ 18 VDC 5 A ±5% 89% 20 – 100 % I <sub>n</sub> ≤5 mA 3 stage Yes Yes Yes Yes 2,23;2,25;2,27;2,3; 1,41–1,5 (20 elem.)
<b>General Data</b> Insulation voltage (In /Out) Insulation voltage (In / PE) Insulation voltage (Out / PE) Protection Class (EN/IEC 60529) Protection class Reliability: MTBF IEC 61709 Pollution Degree Environment Connection Terminal Blocks screw Type Dimensions (W-H-D) Weight	3000 VAC 1605 VAC 500 VAC IP20 I, with PE connected > 300.000 hours 2 2,5mm (24–14AWG) 65x115x135 mm (2.56 x 4.53 x 5.32 in) 0.65 Kg approx. (1.43 lbs.)
<b>Climate Data</b> Ambient temperature (operation) De Rating Ta > 50°C Ambient temperature Storage Humidity at 25°C no condensation Cooling	-25 - +70°C (-13~158°F) - 2.5%(In) / °C -40 – +85°C (-40~185°F) 95% to 25°C Auto Convection
<b>Norms and Certifications</b> Conforming to:	IEC/EN 60335-2-29,EN60950/UL1950, Electrical safety, 89/336/EEC, EMC Directive, 2006/95/EC (Low Voltage),DIN41773 (Charging cycle), Emission:IEC 61000-6-4,Immunity: IEC 61000-6-2.CE
<b>Signal Output (free switch contact)</b> Main or Backup Power Low Battery Fault Battery	Yes Yes Yes
<b>Type of Signal Output Contact</b> Max. current can be switched (EN60947.4.1): Max. DC1: 30 VDC 1 A; AC1: 60 VAC 1A Min.1mA at 5 VDC	Resistive load Min load

# CB245A Battery Charger

## Technical Features

The CB series battery chargers are designed with advanced multi-stage battery charging method, completely automatic and suited to meet the most advanced requirements of battery manufacturers. The Battery Care concept is based on algorithms that implement rapid and automatic charging, battery charge optimization during time, flat batteries recovery and real time diagnostic during installation and operation. The Real Time Autodiagnostic system, monitoring battery faults such as, elements in short circuit, accidental reverse polarity connection, disconnection of the battery, they can easily be detected and removed by help of Blink Code of Diagnosis Led; during the installation and after sell. Each device is suited for all battery types, by means of jumpers it is possible setting predefined curves for Open Lead Acid, Sealed Lead Acid, Gel, Ni-Cd(option). They are programmed for two charging levels, boost and trickle. A rugged casing with bracket for DIN rail mounting provide IP20 protection degree. They are extremely compact and cost-effective.

## Charging

Automatic multi-stage charging and real time diagnostic allow fast recharge and recovery of deep discharged batteries, adding value and reliability to the system hosting. Type of charging is Voltages and current stabilized IUoUo. The state of charging battery and Autodiagnosis of the systems are identified by a flashing code on a Diagnosis LED and Fault Battery LED:

	State	Diagnosis LED	Battery Fault LED
Charging Type	Trickle	1 Blink/sec	OFF
	Boost	2 Blink/sec	OFF
	Recovery	5 Blink/sec	OFF
Auto diagnosis	Reverse polarity	⎓ 1 Blink	ON
	Battery No connect	⎓ 2 Blink	ON
	Element in Short C.	⎓ 3 Blink	ON
	Replace Battery	⎓ 5 Blink	ON

## Jumper for Battery Type Selection

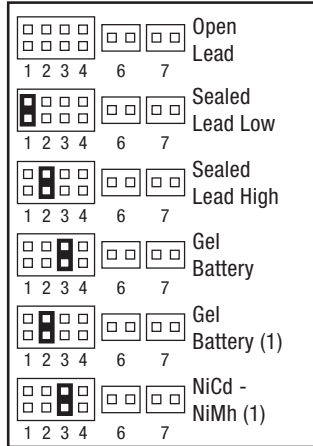

## Jumper for Functional Setting

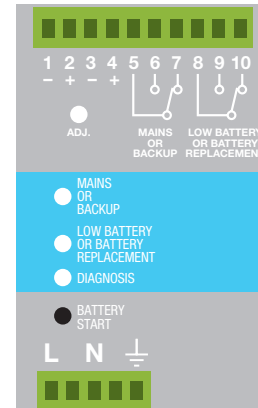
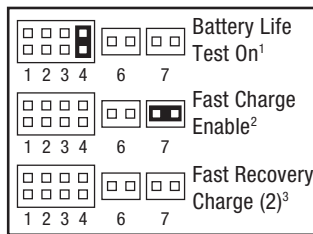

- 1 Jumper present: life test enabled.
- 2 Jumper present: fast test enabled.
- 3 Jumper present: fast recovery charge enabled only for size 3. Possibility to recharge the battery also when the voltage is close to zero with the maximum power of the device.

## Wiring Diagram

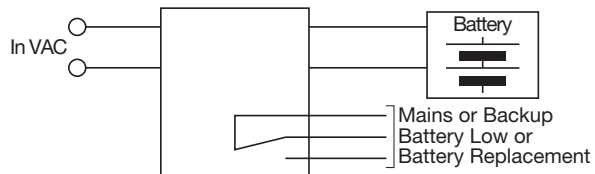

## CB Charging Diagram

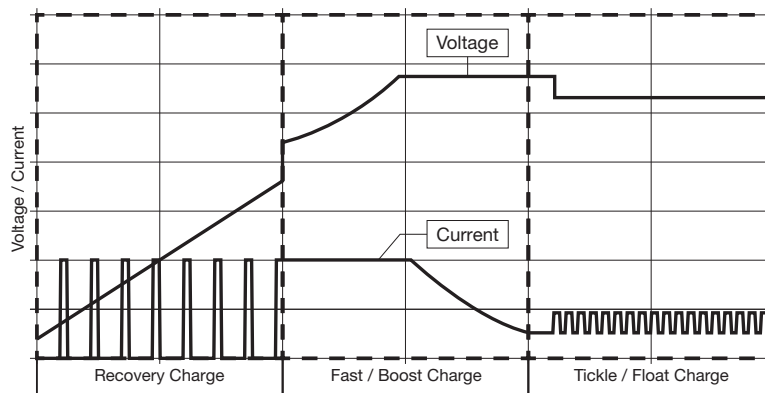



# CB2410A Battery Charger



## Features:

- Input: Single-phase 115 - 230 - 277 VAC
- Output: Battery charging 24 VDC; 10 A
- Suited for the following battery types: Open Lead Acid, Sealed Lead Acid, lead Gel and Ni-Cd (option)
- Automatic diagnostic of battery status. Charging curve IUoUo, constant voltage and current
- Switching technology, output voltage 28.8 VDC
- Three charging levels: Boost, Trickle, Recovery.
- Protected against short circuit, inverted polarity, over load.
- Signal output (contact free) for fault battery state
- Protection degree IP20 - DIN rail mountable

## INPUT

## BATTERY OUTPUT

## GENERAL DATA

## ENVIRONMENT

## SAFETY & EMC

## OTHERS

Cat. No.	CB2410A
<b>Input Data</b> Nominal Input Voltage (2 x VAC) Input Voltage range (VAC) Inrush Current (Vn and In Load) I <sup>2</sup> t Frequency Input Current Internal Fuse External Fuse (recommended)	115 / 230 ~ 277 VAC 90 ~ 135 / 180 ~ 305 VAC ≤ 16 A ≤ 5 msec. 47 ~ 63 Hz ±6% 3.3 A ~ 115 VAC; 2.2 A ~ 230 VAC 6.3 A 16 A (MCB curve B)
<b>Battery Output (Battery Care)</b> Boost charge (25°C) (typ. at I <sub>n</sub> ) Max. time Bust Charge (tpy. at I <sub>n</sub> ) Min. time Bust Charge (tpy. at I <sub>n</sub> ) Trickle charge (25°C) (typ. at I <sub>n</sub> ) Recovery Charge Charging. Max I <sub>batt</sub> (I <sub>n</sub> ) Efficiency (50% - I <sub>n</sub> ) Charging current limiting I <sub>adj</sub> Quiescent Current Charging Curve automatic: IUoUo Detection of element in short circuit Short-circuit protection Over Load protection Over Voltage Output protection Jumper Configuration battery type (V cell) Ni-Cd (optional)	28.8 VDC 15 h 1 min. 27.5 VDC 2 ~ 18 VDC 10 A ±5% 88% 20 – 100 % I <sub>n</sub> ≤5 mA 3 stage Yes Yes Yes Yes 2,23;2,25;2,27;2,3; 1,41–1,5 (20 elem.)
<b>General Data</b> Insulation voltage (In / Out) Insulation voltage (In / PE) Insulation voltage (Out / PE) Protection Class (EN/IEC 60529) Protection class Reliability: MTBF IEC 61709 Pollution Degree Environment Connection Terminal Blocks screw Type Dimensions (W-H-D) Weight	3000 VAC 1605 VAC 500 VAC IP20 I, with PE connected > 300.000 hours 2 2,5mm(24–14AWG) 100x115x135 mm (3.94 x 4.53 x 5.32 in) 0.85 Kg approx. (1.87 lbs.)
<b>Climate Data</b> Ambient temperature (operation) De Rating Ta > 50°C Ambient temperature Storage Humidity at 25°C no condensation Cooling	-25 - +70°C (-13~158°F) - 2.5%(I <sub>n</sub> ) / °C -40 – +85°C (-40~185°F) 95% to 25°C Auto Convection
<b>Norms and Certifications</b> Conforming to:	IEC/EN 60335-2-29,EN60950/UL1950, Electrical safety, 89/336/EEC, EMC Directive, 2006/95/EC (Low Voltage),DIN41773 (Charging cycle), Emission:IEC 61000-6-4,Immunity: IEC 61000-6-2.CE
<b>Signal Output (free switch contact)</b> Main or Backup Power Low Battery Fault Battery	Yes Yes Yes
<b>Type of Signal Output Contact</b> Max. current can be switched (EN60947.4.1): Max. DC1: 30 VDC 1 A; AC1: 60 VAC 1A Min.1mA at 5 VDC	Resistive load Min load

# CB2410A Battery Charger

## Technical Features

The CB series battery chargers are designed with advanced multi-stage battery charging method, completely automatic and suited to meet the most advanced requirements of battery manufacturers. The Battery Care concept is based on algorithms that implement rapid and automatic charging, battery charge optimization during time, flat batteries recovery and real time diagnostic during installation and operation. The Real Time Autodiagnostic system, monitoring battery faults such as, elements in short circuit, accidental reverse polarity connection, disconnection of the battery, they can easily be detected and removed by help of Blink Code of Diagnosis Led; during the installation and after sell. Each device is suited for all battery types, by means of jumpers it is possible setting predefined curves for Open Lead Acid, Sealed Lead Acid, Gel, Ni-Cd(option). They are programmed for two charging levels, boost and trickle. A rugged casing with bracket for DIN rail mounting provide IP20 protection degree. They are extremely compact and cost-effective.

## Charging

Automatic multi-stage charging and real time diagnostic allow fast recharge and recovery of deep discharged batteries, adding value and reliability to the system hosting. Type of charging is Voltages and current stabilized IU0Uo. The state of charging battery and Autodiagnosis of the systems are identified by a flashing code on a Diagnosis LED and Fault Battery LED:

	State	Diagnosis LED	Battery Fault LED
Charging Type	Trickle	1 Blink/sec	OFF
	Boost	2 Blink/sec	OFF
	Recovery	5 Blink/sec	OFF
Auto diagnosis	Reverse polarity	1 Blink	ON
	Battery No connect	2 Blink	ON
	Element in Short C.	3 Blink	ON
	Replace Battery	5 Blink	ON

## Jumper for Battery Type Selection

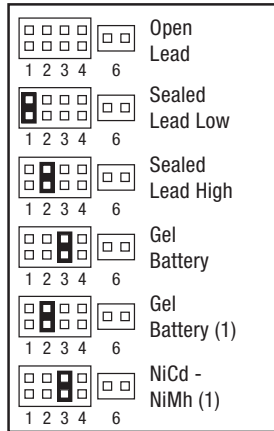

## Jumper for Functional Setting

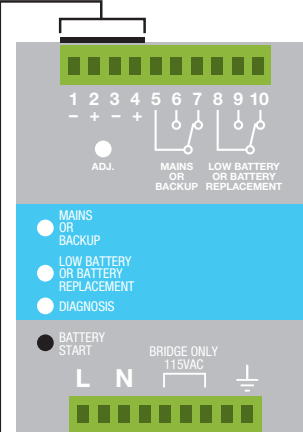
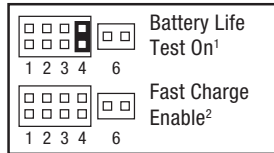

- 1 Jumper present: life test enabled.
- 2 Jumper present: fast test enabled.
- 3 Jumper present: fast recovery charge enabled only for size 3. Possibility to recharge the battery also when the voltage is close to zero with the maximum power of the device.

## Wiring Diagram

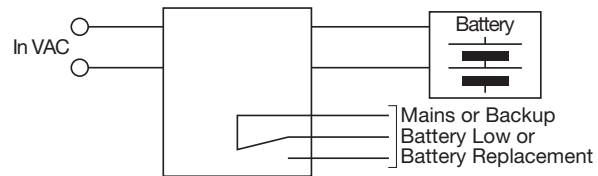

## CB Charging Diagram

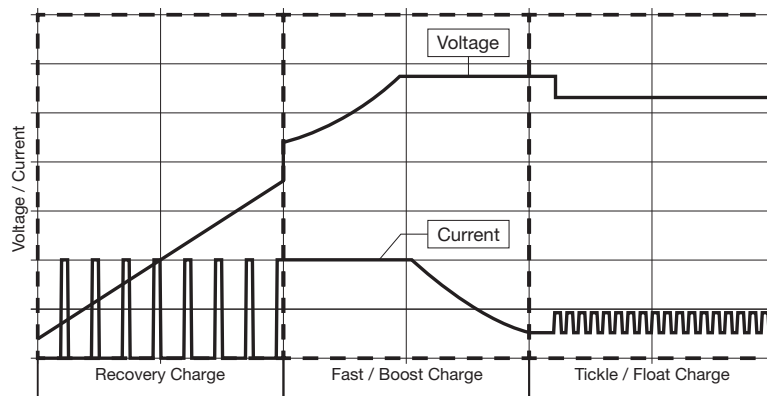



# CB2420A Battery Charger



## Features:

- Input: Single-phase 115 - 277 VAC
- Output: Battery charging 24 VDC; 20 A
- Suited for the following battery types: Open Lead Acid, Sealed Lead Acid, lead Gel and Ni-Cd (option)
- Automatic diagnostic of battery status. Charging curve I<sub>UoUo</sub>, constant voltage and current
- Switching technology, output voltage 28.8 VDC
- Three charging levels: Boost, Trickle, Recovery.
- Protected against short circuit, inverted polarity, over load.
- Signal output (contact free) for fault battery state
- Protection degree IP20 - DIN rail mountable

## INPUT

## BATTERY OUTPUT

## GENERAL DATA

## ENVIRONMENT

## SAFETY & EMC

## OTHERS

### Cat. No.

### CB2420A

#### Input Data

Nominal Input Voltage (2 x VAC)	115 ~ 230 ~ 277 VAC
Input Voltage range (VAC)	90 ~ 135 / 180 ~ 305 VAC
Inrush Current (V <sub>n</sub> and I <sub>n</sub> Load) I <sub>2t</sub>	≤ 35 A ≤ 5 msec.
Frequency	47 ~ 63 Hz ±6%
Input Current	(115 ~ 230 VAC) 8 ~ 4.2 A
Internal Fuse	10 A
External Fuse (recommended)	16 A (MCB curve B)

#### Battery Output (Battery Care)

Boost charge (25°C) (typ. at I <sub>n</sub> )	28.8 VDC
Max. time Bust Charge (typ. at I <sub>n</sub> )	15 h
Min. time Bust Charge (typ. at I <sub>n</sub> )	1 min.
Trickle charge (25°C) (typ. at I <sub>n</sub> )	27.5 VDC
Recovery Charge	2 ~ 18 VDC
Charging. Max I <sub>batt</sub> (I <sub>n</sub> )	20 A ±5%
Adjustable charging current (% I <sub>n</sub> )	20 – 100
Efficiency (50% - I <sub>n</sub> )	91%
Charging current limiting I <sub>adj</sub>	20 – 100 % I <sub>n</sub>
Quiescent Current	≤5 mA
Charging Curve automatic: I <sub>UoUo</sub>	3 stage
Detection of element in short circuit	Yes
Short-circuit protection	Yes
Over Load protection	Yes
Over Voltage Output protection	Yes
Power Supply Mode	Yes
Jumper Configuration battery type (V cell) Ni-Cd (optional)	2,23;2,25;2,27;2,3; 1,41–1,5 (20 elem.)

#### General Data

Insulation voltage (In /Out)	3000 VAC
Insulation voltage (In / PE)	1605 VAC
Insulation voltage (Out / PE)	500 VAC
Protection Class (EN/IEC 60529)	IP20
Protection class	I, with PE connected
Reliability: MTBF IEC 61709	> 300.000 hours
Pollution Degree Environment	2
Connection Terminal Blocks screw Type	4 mm(30–10AWG)
Dimensions (W-H-D)	150x115x135 mm (5.91 x 4.53 x 5.32 in.)
Weight	1.5 Kg approx. (3.31 lbs)

#### Climate Data

Ambient temperature (operation)	-25 - +70°C (-13~158°F)
De Rating Ta > 50°C	- 2.5%(I <sub>n</sub> ) / °C
Ambient temperature Storage	-40 - +85°C (-40~185°F)
Humidity at 25°C no condensation	95% to 25°C
Cooling	Auto Convection

#### Norms and Certifications

Conforming to:	IEC/EN 60335-2-29,EN60950/UL1950, Electrical safety, 89/336/EEC, EMC Directive, 2006/95/EC (Low Voltage),DIN41773 (Charging cycle), Emission:IEC 61000-6-4,Immunity: IEC 61000-6-2.CE
----------------	---

#### Signal Output (free switch contact)

Main or Backup Power	Yes
Low Battery	Yes
Fault Battery	Yes

#### Type of Signal Output Contact

Max. current can be switched (EN60947.4.1):	Resistive load Min load
Max. DC1: 30 VDC 1 A; AC1: 60 VAC 1A	
Min.1mA at 5 VDC	

# CB2420A Battery Charger

## Technical Features

The CB series battery chargers are designed with advanced multi-stage battery charging method, completely automatic and suited to meet the most advanced requirements of battery manufacturers. The Battery Care concept is based on algorithms that implement rapid and automatic charging, battery charge optimization during time, flat batteries recovery and real time diagnostic during installation and operation. The Real Time Autodiagnostic system, monitoring battery faults such as, elements in short circuit, accidental reverse polarity connection, disconnection of the battery, they can easily be detected and removed by help of Blink Code of Diagnosis Led; during the installation and after sell. Each device is suited for all battery types, by means of jumpers it is possible setting predefined curves for Open Lead Acid, Sealed Lead Acid, Gel, Ni-Cd(option). They are programmed for two charging levels, boost and trickle. A rugged casing with bracket for DIN rail mounting provide IP20 protection degree. They are extremely compact and cost-effective.

## Charging

Automatic multi-stage charging and real time diagnostic allow fast recharge and recovery of deep discharged batteries, adding value and reliability to the system hosting. Type of charging is Voltages and current stabilized IUoUo. The state of charging battery and Autodiagnosis of the systems are identified by a flashing code on a Diagnosis LED and Fault Battery LED:

	State	Diagnosis LED	Battery Fault LED
Charging Type	Trickle	1 Blink/sec	OFF
	Boost	2 Blink/sec	OFF
	Recovery	5 Blink/sec	OFF
Auto diagnosis	Reverse polarity	1 Blink	ON
	Battery No connect	2 Blink	ON
	Element in Short C.	3 Blink	ON
	Replace Battery	5 Blink	ON

### Jumper for Battery Type Selection

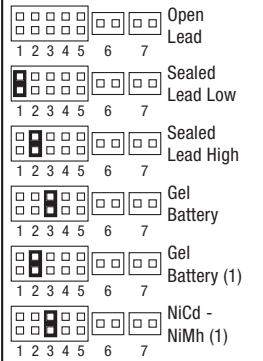

### Jumper for Functional Setting

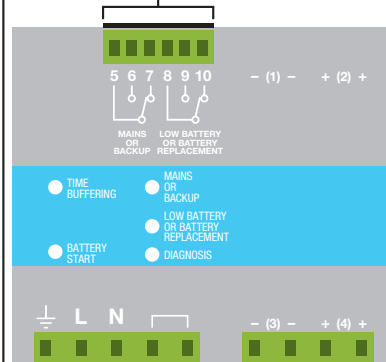
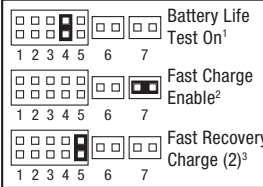

- 1 Jumper present: life test enabled.
- 2 Jumper present: fast test enabled.
- 3 Jumper present: fast recovery charge enabled only for size 3. Possibility to recharge the battery also when the voltage is close to zero with the maximum power of the device.

## Wiring Diagram

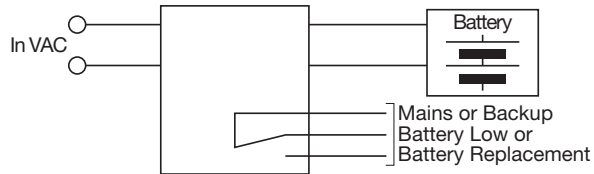

## CB Charging Diagram

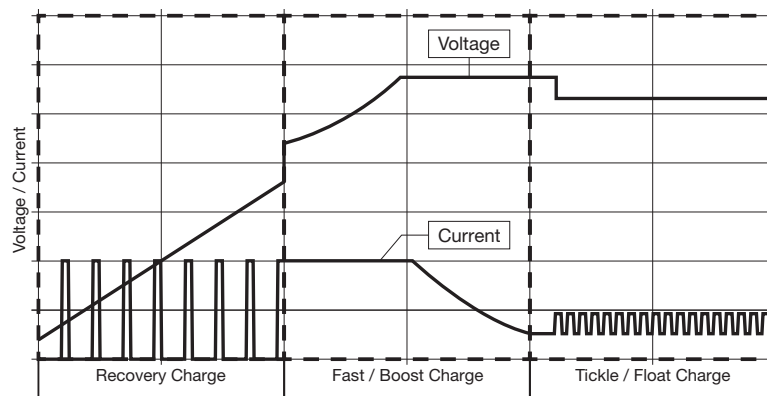





# CB12245A Battery Charger



E353241

## Features:

- Input: Single-phase 115 - 230 - 277 VAC
- Output: Battery charging 12 VDC; 24 VDC (switch select)
- Suited for the following battery types:  
Open Lead Acid, Sealed Lead Acid, lead Gel and Ni-Cd (option)
- Automatic diagnostic of battery status. Charging curve IUoUo, constant voltage and current
- Switching technology, output voltage 14.4 VDC / 28.8 VDC
- Four charging levels: Boost, Absorption, Trickle, Recovery.
- Protected against short circuit, reversed polarity, over load.
- Signal output (contact free) for fault battery state
- Protection degree IP20 - DIN rail mountable

## INPUT

## BATTERY OUTPUT

## GENERAL DATA

## ENVIRONMENT

## SAFETY & EMC

## OTHERS

Cat. No.	CB12245A
<b>Input Data</b> Nominal Input Voltage (2 x VAC) Input Voltage range (VAC) Inrush Current (Vn and In Load) I2t Frequency Input Current Internal Fuse External Fuse (recommended)	115 ~ 230 ~ 277 VAC 90 ~ 305 VAC $\leq 16 \text{ A} \leq 5 \text{ msec.}$ 47 ~ 63 Hz $\pm 6\%$ 2.4 A - 115 VAC; 1.2 A 230 VAC 4 A 10 A (MCB curve B)
<b>Battery Output (Battery Care)</b> Boost charge (25°C) (typ. at In) Max. time Bust Charge (typ. at In) Min. time Bust Charge (typ. at In) Trickle charge (25°C) (typ. at In) Recovery Charge Charging. Max I <sub>batt</sub> (In) Efficiency (50% - In) Charging current limiting I <sub>adj</sub> Quiescent Current Charging Curve automatic: IUoUo Detection of element in short circuit Short-circuit protection Over Load protection Over Voltage Output protection Jumper Configuration battery type (V cell) Ni-Cd (optional)	14.4 VDC / 28.8 VDC (jumper section) 15 h 4 min. 13.75 VDC / 27.5 VDC 2 ~ 7 VDC / 2 ~ 16 VDC 6A@12V / 5A@24V DC 90% 20 – 100 % I <sub>n</sub> $\leq 5 \text{ mA}$ 3 stage Yes Yes Yes Yes 2,23;2,25;2,27;2,3; 1,41–1,5 (20 elem.)
<b>General Data</b> Insulation voltage (In /Out) Insulation voltage (In / PE) Insulation voltage (Out / PE) Protection Class (EN/IEC 60529) Protection class Reliability: MTBF IEC 61709 Pollution Degree Environment Connection Terminal Blocks screw Type Dimensions (W-H-D) Weight	3000 VAC 1605 VAC 500 VAC IP20 I, with PE connected > 300.000 hours 2 2,5mm(24–14AWG) 45x105x100 mm (1.78 x 3.94 x 3.94 in.) 0.3 Kg (0.65 lbs) approx.
<b>Climate Data</b> Ambient temperature (operation) De Rating Ta > 50°C Ambient temperature Storage Humidity at 25°C no condensation Cooling	-25 - +70°C (-13~158°F) - 2.5%(In) / °C -40 - +85°C (-40~185°F) 95% to 25°C Auto Convection
<b>Norms and Certifications</b> Conforming to:	IEC/EN 60335-2-29,EN60950/UL1950, Electrical safety, 89/336/EEC, EMC Directive, 2006/95/EC (Low Voltage),DIN41773 (Charging cycle), Emission:IEC 61000-6-4,Immunity: IEC 61000-6-2.CE
<b>Signal Output (free switch contact)</b> Main or Backup Power Low Battery Fault Battery	Yes Yes Yes
<b>Type of Signal Output Contact</b> Max. current can be switched (EN60947.4.1): Max. DC1: 30 VDC 1 A; AC1: 60 VAC 1A Min.1mA at 5 VDC	Resistive load Min load



# CB12245A Battery Charger

## Technical Features

The CB series battery chargers are designed with advanced multi-stage battery charging method, completely automatic and suited to meet the most advanced requirements of battery manufacturers. The Battery Care concept is based on algorithms that implement rapid and automatic charging, battery charge optimization during time, flat batteries recovery and real time diagnostic during installation and operation. The Real Time Autodiagnostic system, monitoring battery faults such as, elements in short circuit, accidental reverse polarity connection, disconnection of the battery, they can easily be detected and removed by help of Blink Code of Diagnosis Led; during the installation and after sell. Each device is suited for all battery types, by means of jumpers it is possible setting predefined curves for Open Lead Acid, Sealed Lead Acid, Gel, Ni-Cd(option). They are programmed for two charging levels, boost and trickle. A rugged casing with bracket for DIN rail mounting provide IP20 protection degree. They are extremely compact and cost-effective.

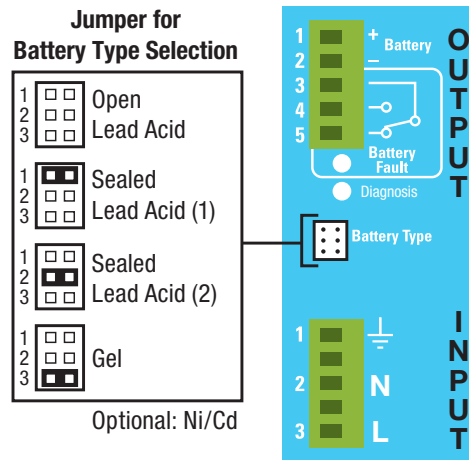

## Charging

Automatic multi-stage charging and real time diagnostic allow fast recharge and recovery of deep discharged batteries, adding value and reliability to the system hosting. Type of charging is Voltages and current stabilized IUoUo. The state of charging battery and Autodiagnosis of the systems are identified by a flashing code on a Diagnosis LED and Fault Battery LED:

## Wiring Diagram

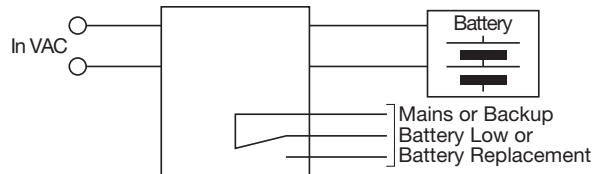

	State	Diagnosis LED	Battery Fault LED
Charging	Trickle	1 Blink/sec	OFF
	Absorption	1 Blink/sec	OFF
	Boost	3 Blink/sec	OFF
	Recovery	5 Blink/sec	OFF
Auto diagnosis	Reverse polarity	1 Blink	ON
	Battery No connect	2 Blink	ON
	Element in Short C.	3 Blink	ON
	Replace Battery	5 Blink	ON

## CB Charging Diagram

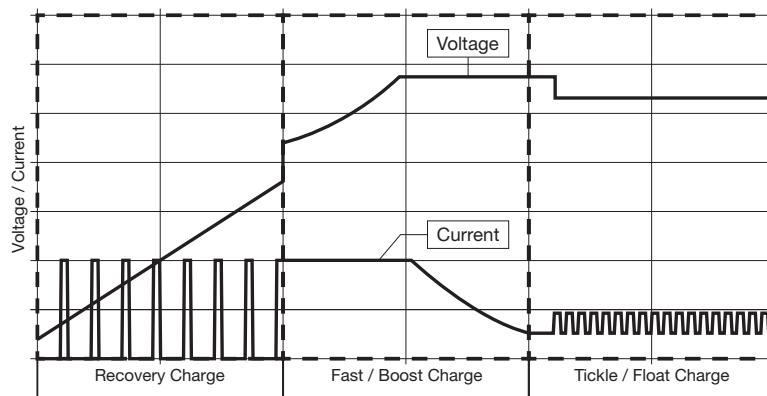

# Accessories



## Power Supply Redundancy Buffer Module

PS-RDN20 is a 20A redundancy (decoupling) module for the 24V DC power system. Containing 2 sets of 20A Or-ing diodes with wonderful heat dissipation deployment, PS-RDN20 give you a new option for safe connection of 1+1 redundant set-up. Not only perfectly decouple power sources from each other as well as from the load, PS-RDN20 also provides users monitoring signals for both input channels through the built-in relays. Since there's no switching components inside the module, PS-RDN20 will not arise additional EMI issues and should provide you a worry-free application platform!

DC input voltage range	21~28V, 20A max. x 2 channels
Reverse voltage	30V
DC output current	20A max.
DC output voltage drop	0.5V max.
Input voltage alarm	When input is > 20V(±5%) or <30V(±5%), relay contacts
Relay contact rating	30VDC, 1A
Working Temperature	-20~+70°C
EMC standards	EN55022 class B, EN61000-4-2,3,4,5,6,8, ENV50204
Connection	I/P: 4 poles, O/P: 2 poles screw DIN terminal, Single output: 4 poles

## UPS Battery Module

PS-UPS40 is a 40A max. DC UPS (battery control) module for the 24 V DC power system. Accompany with external batteries, it can back-up up to 40A of current to critical loads for certain period of time depending on the capacity of batteries. With complete monitoring signals and LED indicators for DC BUS OK, Battery Fail, Battery Discharge and the repeated Battery Test function to check the situation of external batteries. Users can customize their own DC UPS system to back up critical loads and capture the status of the whole system easily.

DC input / DC bus	24~29V, 40A max.
Battery in/out voltage	21~29V
Battery input current	0~40A
Charge current (typ.)	2A
External battery (typ.)	24V, 4AH / 7AH / 12AH
DC bus ok	Relay status: Short when DC voltage between 21~29V(±3%), relay contacts
Battery fail	Relay status: Short when battery failure is observed through the battery test function, relay contacts LED (red): Battery over-discharge warning or battery broken: light; battery OK: dark
Battery discharge	Relay status: Short when battery in discharge condition, relay contacts LED (yellow): Battery discharging: light; battery is not discharging or discharging current <2A: dark
Working temperature	-20~+70°C
EMC standards	EN55022 class B, EN61000-4-2,3,4,5,6,8, ENV50204
Connection	I/P: 2 poles, O/P: 2 poles screw DIN terminal, Single output: 6 poles

# Redundancy Buffer Module UPS Battery Module



## Redundancy Buffer Module Features:

- Suitable for redundant operation of 24V system
- Installed on 35 x 7.5 mm or 35 x 15 mm DIN Rail
- Relay contact signal output and LED indicator for input failure alarm
- Cooling by free air convection
- 3 year warranty

## UPS Battery Module Features:

- Battery controller for DIN Rail UPS system
- Installed on 35 x 7.5 mm or 35 x 15 mm DIN Rail
- Parallel connection to DC BUS
- Suitable for 24V system up to 40A
- Built-in battery test function
- Battery polarity protection
- Relay contact signal output and LED indicator for DC BUS OK, battery fail and battery discharge
- Cooling by free air convection
- 3 year warranty

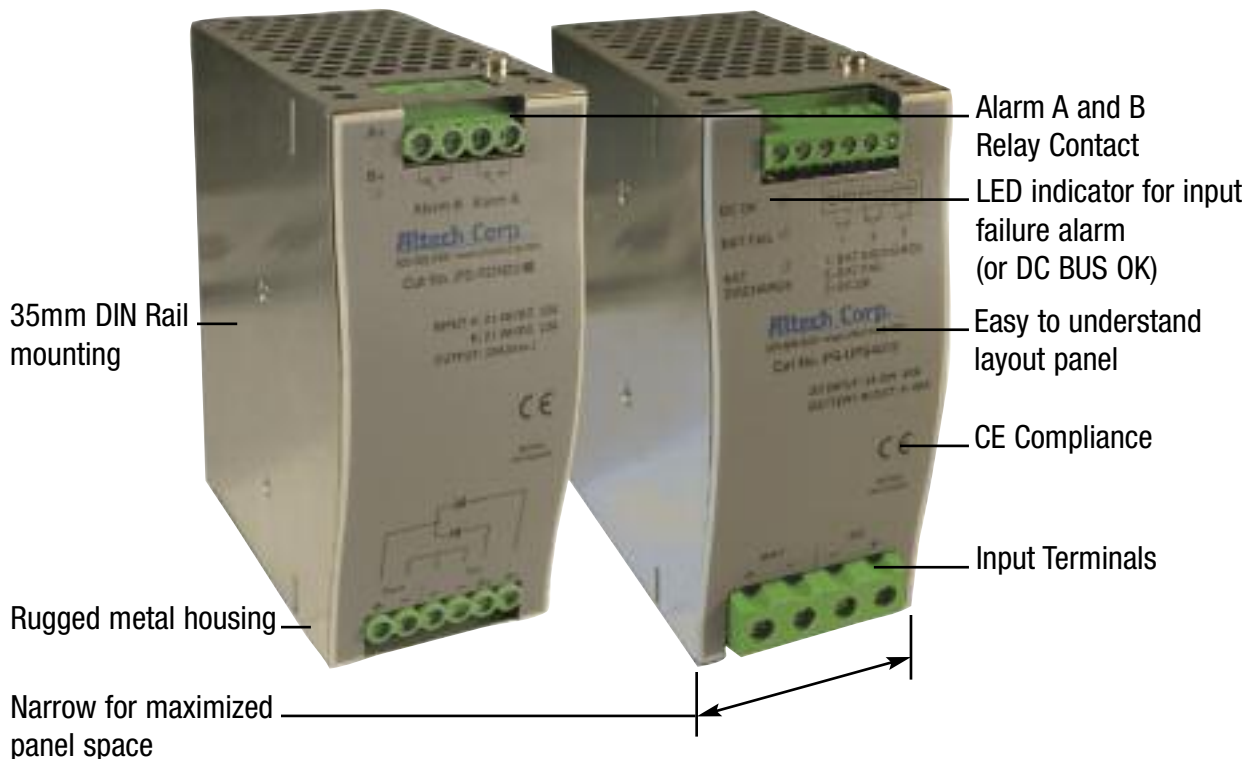

# Accessories

- REDUNDANCY BUFFER MODULE
- UPS MODULE



## Power Supply Redundancy Buffer Module

PS-RDN20 is a 20A redundancy (decoupling) module for the 24V DC power system. Containing 2 sets of 20A Oring diodes with excellent heat dissipation deployment. PS-RDN20 give you a new option for safe connection of 1+1 redundant set-up. Not only perfectly decouple power sources from each other as well as from the load, PS-RDN20 also provides users monitoring signals for both input channels through the built-in relays. Since there's no switching components inside the module, PS-RDN20 will not arise additional EMI issues and should provide you a worry-free application platform!

Cat. No.	Voltage Range	Current Range	NOTES
----------	---------------	---------------	-------

PS-RDN20	21-28V DC	0-20A	
----------	-----------	-------	--

Connection: Terminal 1 - 4 poles, Terminal 2 - 6 poles  
 Size (WxHxD): 55.5x125x100mm (2.19x4.95x3.95 inches)  
 Packaging: 1/box; 1.1lbs / 0.5Kg

[DC Fail Block Diagram](#)



## 40 AMP UPS Battery Controller

PS-UPS40 is a 40A max. DC UPS (battery control) module for the 24 V DC power system. Accompany with external batteries, it can back-up up to 40A of current to critical loads for certain period of time depending on the capacity of batteries. With complete monitoring signals and LED indicators for DC BUS OK, Battery Fail, Battery Discharge and the repeated Battery Test function to check the situation of external batteries. Users can customize their own DC UPS system to back up critical loads and capture the status of the whole system easily.

Cat. No.	Voltage Range	Current Range	NOTES
----------	---------------	---------------	-------

PS-UPS40	21-29V (Battery) 24-29V (DC)	0 - 40A	
----------	---------------------------------	---------	--

Connection: Terminal 1 - 4 poles, Terminal 2 - 6 poles  
 Size (WxHxD): 55.5x125x100mm (2.19x4.95x3.95 inches)  
 Packaging: 1/box; 1.21lbs / 0.55Kg

# SPECIFICATIONS

## PS-RDN20 Series

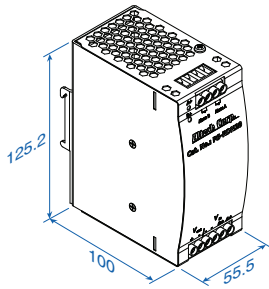

Terminal Pin. No Assign. (TB1)

Pin No.	Assignment
1	Vout+
2	Vout-
3,4	Vin-
5	Vin B+
6	Vin A+

Terminal Pin. No Assign. (TB2)

Pin No.	Assignment
1	Alarm B1
2	Alarm B2
3	Alarm A1
4	Alarm A2

### Derating Curve

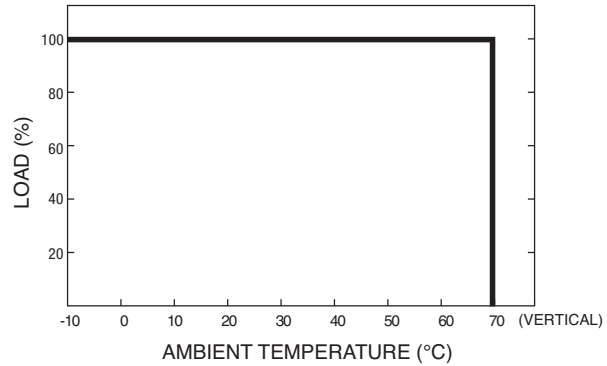

### Applications:

1. 1+1 Redundancy  
Using 1 more PSU  
as the redundant unit

2. 1+N Redundancy: Using more PSUs as the redundant units to increase the reliability

3. Single Use: Connecting only one PSU to one PS-RDN20 to reduce the stress of the diodes and hence increase the reliability

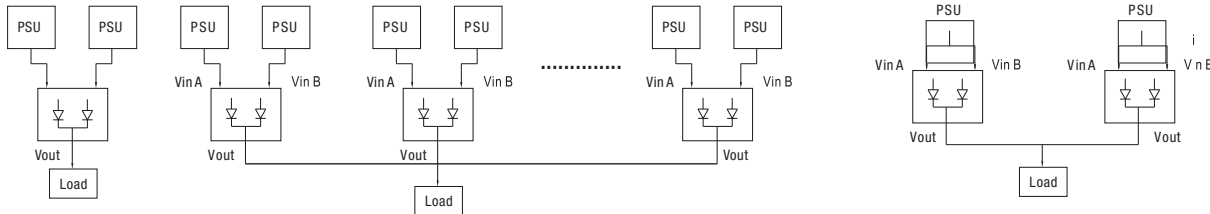

## PS-UPS40 Series

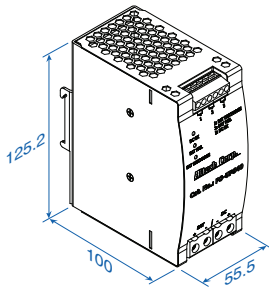

Terminal Pin. No Assign. (TB1)

Pin No.	Assignment
1	BATTERY INPUT +
2	BATTERY INPUT -
3	DC INPUT -
4	DC INPUT +

Terminal Pin. No Assign. (TB2)

Pin No.	Assignment
1	BAT DISC 1
2	BAT DISC 2
3	BAT OK 1
4	BAT OK 2
5	DC OK 1
6	DC OK 2

### Derating Curve

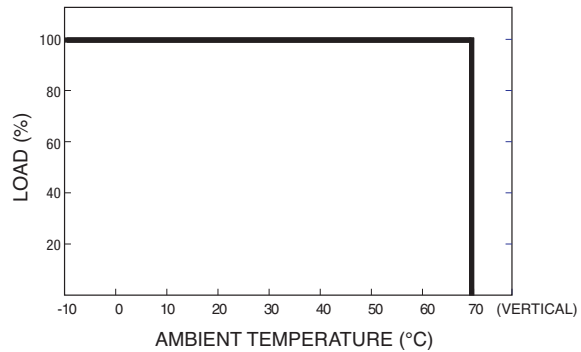

1. Backup connection for AC interruption

2. Combine redundancy module (PS-RDN20) to back up AC interruption or failure of PSU

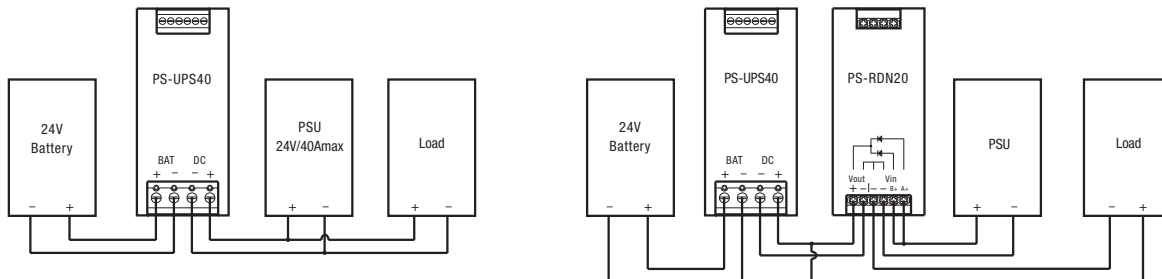

Note: All dimensions are in millimeters, to convert to inches multiply by 0.03937.



# PS-RDN20

## Specifications



### Features:

- Suitable for redundant operation of 24V system
- Installed on DIN Rail TS35 / 7.5 or 15
- Relay contact signal output and LED indicator for input failure alarm
- Cooling by free air convection
- 3 year warranty

### DC INPUT/ DC BUS

Cat. No.	PS-RDN20
REVERSE VOLTAGE (max.)	30V
OUTPUT CURRENT (max.)	20A
VOLTAGE DROP	0.5V
LED INDICATORS	Two green LED's indicating each input is OK or fail
INPUT VOLTAGE RANGE	21 ~ 28V
NUMBER OF INPUTS	Two
INPUT CURRENT (max.)	20A per input
INPUT VOLTAGE ALARM	When input is $\geq 20V (\pm 5\%)$ or $\leq 30V (\pm 5\%)$ relay contacts
RELAY CONTACT RATING (max.)	
WORKING TEMP.	-20 ~ +70°C
WORKING HUMIDITY	20 ~ 90% RH non-condensing
STORAGE TEMP., HUMIDITY	-40 ~ +85°C, 10 ~ 95% RH
VIBRATION	10 ~ 500Hz, 2G 10min./1cycle, 60 min. each long X,Y, Z axes
MOUNTING	Compliance to IEC60068-2-6
WITHSTAND VOLTAGE	Terminal- Chassis: 0.5KVAC, Relay Contacts- Terminal: 0.5KVAC Terminal- Chassis: $\geq 100M$ Ohms / 500VDC (25°C; 70% RH) Compliance to EN55022 (CISPR22) Class B Compliance to EN61000-4-2,3,4,5,6,8; ENV50204; heavy industry level; criteria A,
ISOLATION RESISTANCE	
EMI CONDUCTION & RADIATION	
EMS IMMUNITY	
MTBF	996.8Khrs min. MIL-HDBK-217K (25°C)
DIMENSION	55.5x125.2x100mm (WxHxD)
PACKING	0.5Kg; 20pcs / 11Kg / 1.29CUFT

### BATTERY IN / OUTPUT

### FUNCTION

### ENVIRONMENT

### SAFETY & EMC

### OTHERS

All parameters NOT specially mentioned are measured at 24V DC input, rated load and 25°C of ambient temperature.

## Mechanical Specification

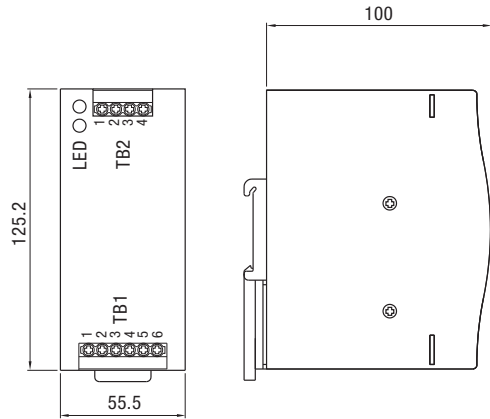

Terminal Pin. No Assignment (TB1)

Pin No.	Assignment
1	Vout+
2	Vout-
3,4	Vin-
5	Vin B+
6	Vin A+

Terminal Pin. No Assignment (TB2)

Pin No.	Assignment
1	Alarm B1
2	Alarm B2
3	Alarm A1
4	Alarm A2

## Block Diagram

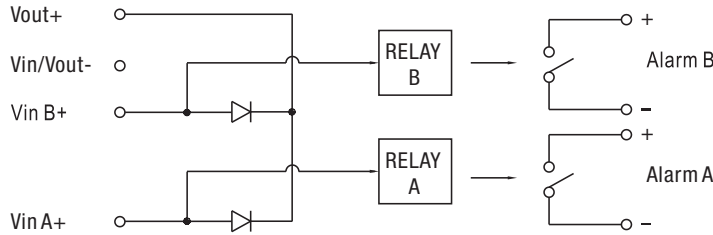

## Applications

1. 1+1 Redundancy  
Using 1 more PSU  
as the redundant unit

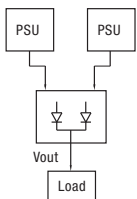

2. 1+N Redundancy: Using more PSUs as the redundant units to increase the reliability

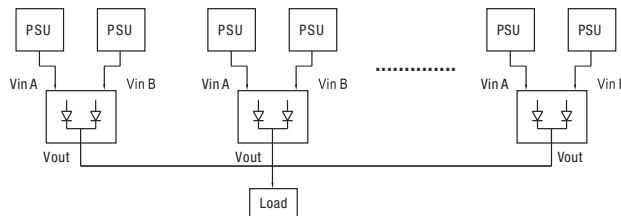

3. Single Use: Connecting only one PSU to one PS-RDN20 to reduce the stress of the diodes and hence increase the reliability

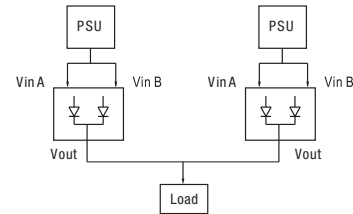

## Derating Curve

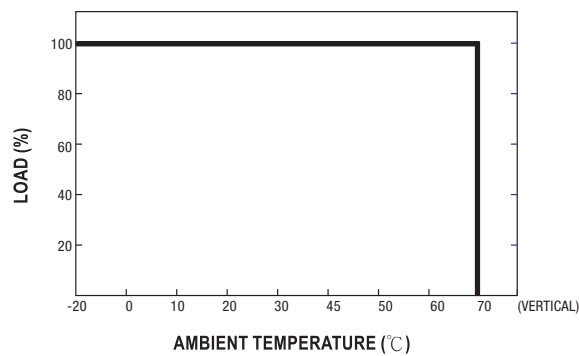

Note: All dimensions are in millimeters, to convert to inches multiply by 0.03937.





# PS-UPS40

## Specifications



### Features:

- Battery controller for DIN Rail UPS system
- Parallel connection to DC BUS
- Suitable for 24V system up to 40A
- Installed on DIN Rail TS35/ 7.5 or 15
- Built-in battery test function
- Battery polarity protection
- Relay contact signal output and LED indicator for DC BUS OK,
- Battery fail, and battery discharge
- Cooling by free air convection
- 3 year warranty

### DC INPUT/ DC BUS

### BATTERY IN / OUTPUT

### FUNCTION

### ENVIRONMENT

### SAFETY & EMC

### OTHERS

Cat. No.	PS-UPS40
DC VOLTAGE (Typ.)	24 ~ 29V
RATED CURRENT	40A
VOLTAGE RANGE (Typ.)	21 ~ 29V
CURRENT RANGE	0 ~ 40A
CHARGE CURRENT (Typ.)	2A
EXTERNAL BATTERY (Typ.)	4 / 7 / 12AH / 24V
RELAY CONTACT RATING (max.)	30VDC, 1A
DC BUS OK	Relay contact: Short when DC voltage between 21 ~ 29V ( $\pm 3\%$ ), relay contacts LED (Green): DC BUS OK: light; DC BUS fail: dark
BATTERY FAIL	Relay contact: Short when battery failure is observed through the battery test function, relay contacts LED (Red): Battery over- discharge warning or battery broken: light; Battery OK: dark Every 25 seconds, unit will send out test signal through Battery Fail relay contact and LED indicator once the battery is fail.
BATTERY DISCHARGE	Relay contact: Short when battery in discharge condition, relay contacts LED (Yellow): Battery discharging: light; Battery is not discharging or discharging current $\leq 2.0A$ : dark
WORKING TEMP.	-20 ~ +70°C
WORKING HUMIDITY	20 ~ 90% RH
STORAGE TEMP., HUMIDITY	-20 ~ +85°C, 10 ~ 95% RH
VIBRATION	10 ~ 500Hz, 2G 10min./1cycle, 60 min. each long X,Y, Z axes
MOUNTING	Compliance to IEC60068-2-6
WITHSTAND VOLTAGE	Terminal- Chassis: 0.5KVAC, Relay Contacts- Terminal: 0.5KVAC
ISOLATION RESISTANCE	Terminal- Chassis: $\geq 100M$ Ohms / 500VDC (25°C; 70% RH)
EMI CONDUCTION & RADIATION	Compliance to EN55022 (CISPR22) Class B
EMS IMMUNITY	Compliance to EN61000-4-2,3,4,5,6,8; ENV50204; heavy industry level; criteria A
MTBF	161.9Khrs min. MIL-HDBK-217K (25°C)
DIMENSION	55.5x125.2x100mm (WxHxD)
PACKING	0.55Kg; 20pcs / 12Kg / 1.29CUFT
All parameters NOT specially mentioned are measured at rated load and 25°C of ambient temperature.	

## Mechanical Specification

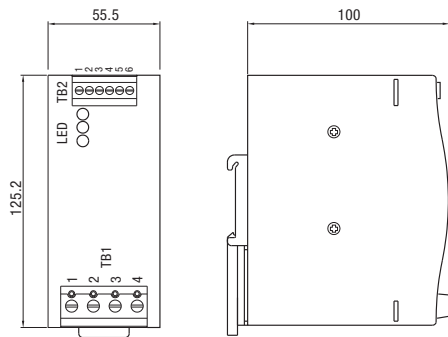

Terminal Pin. No Assignment (TB1)

Pin No.	Assignment
1	BATTERY INPUT +
2	BATTERY INPUT -
3	DC INPUT -
4	DC INPUT +

Terminal Pin. No Assignment (TB2)

Pin No.	Assignment
1	BAT DISC 1
2	BAT DISC 2
3	BAT OK 1
4	BAT OK 2
5	DC OK 1
6	DC OK 2

## Block Diagram

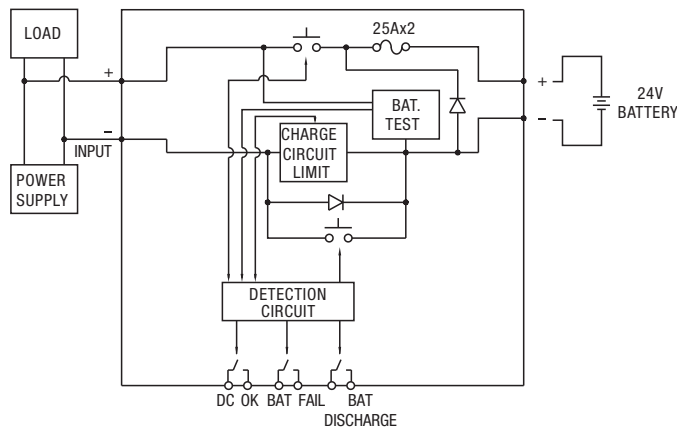

## Applications

1. Backup connection for AC interruption

2. Combine redundancy module (PS-RDN20) to back up AC interruption or failure of PSU

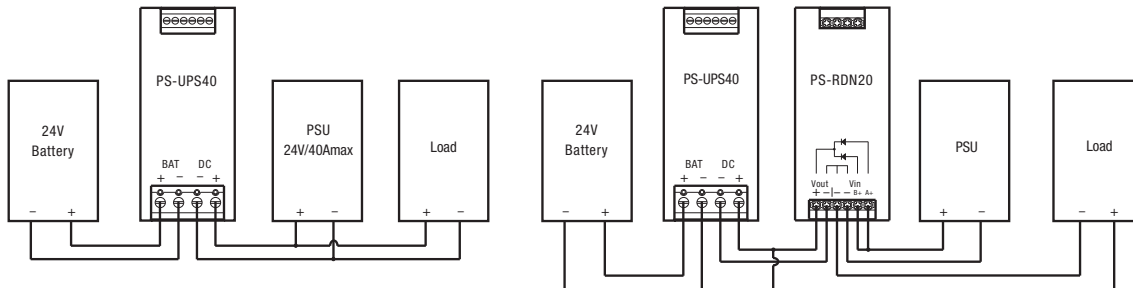

## Derating Curve

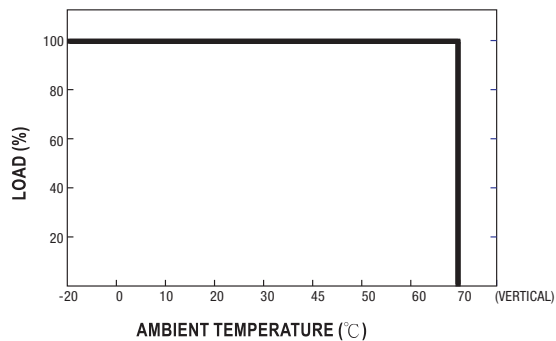

Note: All dimensions are in millimeters, to convert to inches multiply by 0.03937.

## Battery Backup Enclosures with VRLA Batteries

Compact and fully enclosed improve safety and maintenance, transmit information on the temperature and type of included valve-regulated acid batteries. They save space and improve the efficiency of the DC UPS.



Cat. No.	Output	Protection Current	Dimensions h x w x d (mm)	Weight kg (approx.)
BAT-1.2VRLA	24V - 1.2Ah	25 A fuse	62 x 175 x 120	1.5
BAT-3.4VRLA	24V - 3.2Ah	25 A fuse	82 x 200 x 160	3
BAT-7.2VRLA	24V - 7.2Ah	25 A fuse	145 x 210 x130	5.5
BAT-12VRLA	24V - 12Ah	25 A fuse	210 x 210x210	9

## Battery Housing Without Batteries

Compact and fully enclosed improve safety and maintenance, transmit information on the temperature and type of batteries. They save space and improve the efficiency of the DC UPS. Size for 24 VDC: 1.2 Ah, 3 Ah, 7.2 Ah and 12 Ah, batteries are not included.



Cat. No.	Battery Type	Protection Current	Dimensions h x w x d (mm)	Weight kg (approx.)
BTH-1.2	2x 12V/1.2AH	25 A fuse	62 x 175 x 120	0.5
BTH-3.4	2x 12V/3.4AH	25 A fuse	82 x 200 x 160	0.9
BTH-7.2	2x 12V/7.2AH	25 A fuse	145 x 210 x130	1.5
BTH-12	2x 12V/12AH	25 A fuse	210 x 210x210	1.9

## Battery Holders

Battery holders for DC UPS system is used in conjunction with a 12 or 24V CBI system. They are designed for maintenance free lead acid batteries (batteries are not included) and protected with a fuse. Units can be installed on a standard 35 mm din rail or wall mounted with a M4 type screw (screws not included).

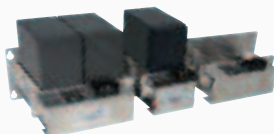

*Photo shown with batteries. Please consult Altech for units with battery options.*

Cat. No.	Battery Size AH	Protection A	Dimensions WxHxD (mm)	Weight KG (with battery)	Mounting
BTM-123	12V/3.2Ah	25A fuse	105x136x90	1.6	M4 SCREW
BTM-123D	12V/3.2Ah	25A fuse	105x136x90	1.6	DIN RAIL
BTM-127	12V/7.2Ah	25A fuse	105x153x123	2.4	M4 SCREW
BTM-127D	12V/7.2Ah	25A fuse	105x153x123	2.4	DIN RAIL
BTM-1212	12V/12Ah	25A fuse	170x153x123	3.5	M4 SCREW
BTM-241	2 x 12V/1.2Ah	25A fuse	170x102x80	1.4	M4 SCREW
BTM-241D	2 x 12V/1.2Ah	25A fuse	170x102x80	1.4	DIN RAIL
BTM-243	2 x 12V/3.2Ah	25A fuse	170x136x90	3.1	M4 SCREW
BTM-243D	2 x 12V/3.2Ah	25A fuse	170x136x90	3.1	DIN RAIL
BTM-247	2 x 12V/7.2Ah	25A fuse	170x153x123	4.7	M4 SCREW
BTM-247D	2 x 12V/7.2Ah	25A fuse	170x153x123	4.7	DIN RAIL
BTM-2412	2 x 12V/12Ah	25A fuse	235x153x123	7.9	M4 SCREW

## Battery Selection Chart

Battery Type	1.2 Ah	3 Ah	7.2 Ah	12 Ah
Load 1.5 A	20	60	200	400
Load 3 A	8	30	120	240
Load 5 A	3	15	55	100
Load 7.5 A	2	10	30	60
Load 10 A	No	7	20	45
Load 12 A	No	3	12	30
Load 15 A	No	No	9	20
Load 20 A	No	No	7	13

## Ultra Capacitor Modules

Traditional lead-acid batteries rely on aging technology and toxic chemicals for energy storage. While adequate for many applications, they have limitations for emerging applications that require safe, dependable, quick-back up power, over long periods of time.

Ultracapacitors in DC-UPS applications, ensure that critical information and functions are available when supply voltage dips, sags, drops out or surges, or during a battery changeover. Working in conjunction with a complementary power supply, Ultracapacitors modules reliably supply energy in peak power demand conditions, short power outages and reducing stress on the primary power supply and extending its usable life.

Benefits:

- Environmentally safe
- Virtually maintenance free
- Operating temperature range -40°C to +65°C
- Higher power vs. batteries
- No toxic chemicals
- Lasts up to 15 years\*\*
- Higher energy vs. electrolytic capacitors
- Resists shock and vibration

### C-TEC Ultra capacitor module

The DC- buffer module of the series C-TEC works with ultra-capacitors as energy storage inside the housing. These capacitors are charge by a external regulated DC-power supply in normal operation. In case of an interruption of the DC-power supply the energy of the capacitors is released. The load is supplied by the buffer module till it is discharged. The back-up time depends on the state of charge of the capacitors and on the discharge current.



Cat. No.	prim. V	sec. V	output A	imax* A	energy Ws	dimensions h x w x d (mm)	weight kg
C-TEC 2403-1	24	24	3	6	1000	92,5x60x116	0.55
C-TEC 2405-5	24/12	24/12	5	7	5000	163x114x145	1.8
C-TEC 2410-10	24/12	24/12	10	10	10000	163x114x145	2.1
C-TEC 2420-8	24	24	20	20	8000	192x84x192	1.8
C-TEC 2440-4P	24	24	40	40	4000	192x84x198	2.0

AC-TEC 2403-1	115 – 230 VAC	24	3	1.5xIA	1000	152,5 x 72 x 130	0.85
AC-TEC 2420-8	3 x 340 – 550 VAC	24	20	1.5xIA	8000	192,5 x 140 x 198	0.55

### Capacitor Extension Module

The CEM-Module is used to increase the back-up energy of the C-TEC series. The charging and discharging of the extension module is monitored and controlled by the C-TEC.



Cat. No.	nominal voltage V DC	sec. V DC	output A	imax* A	energy Ws	dimensions h x w x d (mm)	weight kg
CEM 1	24	24	3	3	1kJ, 1000Ws	92,5x60x116	0.85
CEM 2	24	24	3	3	2kJ, 2000Ws	92,5x60x116	1
CEM 8	24	24	20	20	8kJ, 8000Ws	192x84x192	1.4
CEM 16	24	24	20	20	16kJ, 16000Ws	192x84x192	1.9

### AKKUTEC DC-UPS Buffer Unit (without batteries)

The battery buffered DC power supply is working according the stand-by parallel mode and ensures in connection with a lead-acid battery a safe continuous DC power supply during a determined time interval in case of mains failure. The total output current is shared between supply of the loads and charging of the buffer unit.



Cat. No.	prim. V	sec. V	output A	dimensions h x w x d (mm)	weight kg
AKKUTEC 2402	115 - 230	24	2	60x92,5x116	0.55
AKKUTEC 2405	115-230	24	5	160x75x150	1
AKKUTEC 2412	230	24	12	155x95x183	0.4
AKKUTEC 2440	3x400	24	44	180x290x150	3.3

# Frequently Asked Questions

## Notes on choosing a switching power supply?

- To increase the reliability of the switching power supply, we suggest users choose a unit that has a rating of 30% more power than actual need. For example, if the system needs a 90W source, we suggest that users choose a switching power supply with 120W of output power or more. By doing this, you can effectively boost the reliability of the switching power supply in your system.
- We also need to consider about ambient temperature of the switching power supply and whether there is additional device for dissipating the heat. If the switching power supply is working in a high temperature environment, we need to make some derating to the output power. The derating curve of "ambient temperature" versus "output power" can be found on our spec sheets.
- Choosing functions based on your application:
  - Protection function:
    - Overvoltage Protection (OVP)
    - Overtemperature Protection (OTP)
    - Overload Protection (OLP)
    - Short Circuit Protection (SCP)
  - Application function:
    - Signaling Function (Power Good, Power Fail)
    - DC OK Signal
  - Special function:
    - Power Factor Correction (PFC)
    - Uninterruptible Power Supply (UPS) function
    - Pick Load Capability
    - Make sure that the model qualifies for the safety standards and EMC regulations you need.

## Can a power supply used to charge a battery?

ALTECH power supplies are not specifically designed for battery charging, but we offer a full line of intelligent battery chargers and DC UPS solutions. If you decide to choose a Power Supply as a battery charger, our advice is to pick a power supply with over load protection (OLP) which mode is constant current limiting. The models in this mode provide constant current even when the protection circuit is triggered.

The second choice is fold-back current limiting or constant wattage model. In this model, when a battery is running low, the output current of the power supply will gently increase. The level of increase depends on battery's capacity and degree of exhaustion.

Power supplies set to Hiccup mode are not recommended because it will stop to generate current when OLP happens.

## What is the CB type battery charger?

The CB type intelligent battery charger is a microcontroller equipped device that offers a fully automatic multi stage battery charging that expands the battery life significantly.

## What is the All in one DC UPS power solution?

The CBI All in One UPS power solution combines the requirements of several applications in one single device. It can be used as a power supply unit, battery charger, battery care module and back up module. Only thing needs to be added it's a battery to create a complete DC UPS system.

## Does Altech carry NEC class 2 power supplies?

The Altech PSC line of power supplies in addition to meet with the NEC requirements they are also UL1310 tested and recognized. More information can be found on the individual specification sheets.

**Can ALTECH's power supply be used in the range of 45Hz ~ 440Hz? If YES, what will happen?**

ALTECH's power supply can be used within this frequency range. But if the frequency is too low, the efficiency will also be lower. For example, when a PS-12024 is operated under 230VAC and rated load, if the frequency of AC input is 60 Hz, the efficiency is around 84%; however, if the frequency of AC input reduces to 50 Hz, the efficiency will be around 83.8%. If the frequency is too high, the power factor of the switching power supply with PFC (power factor correction) function will reduce and this also will cause higher leakage current. For example, when a PS-12024 is operated under 230VAC and rated load, if the frequency of AC input is 60 Hz, the power factor is 0.93 and the leakage current is around 0.7mA; however, if the frequency of AC input increase to 440 Hz, the power factor will decrease to 0.75 and the leakage current will rise to around 4.3mA.

**If we need a 30VDC output power supply, but ALTECH does not have this model, can we use two 15VDC power supplies connecting in series instead of one 30VDC power supply?**

YES, basically you can do this to get the right output voltage, but be careful that the rated output current of the series system should be the rating of the minimum one in these series connected power supplies. Furthermore, we like you to parallel a diode at the output of power supply to prevent possible damage of internal capacitors.

**Why I cannot turn on the power supply smoothly when the loads are motors, light bulbs or capacitive loads?**

If you connect the switching power supply to motors, light bulbs, or high capacitive loads, you will have a high output surge current when you turn on the S.P.S. and this high surge current will cause failure of start up. We suggest using switching power supply with over load protection and constant current limiting protection to deal with these loads.

**Why did the power supply shuts down during operation and after turning it off, I can restart the power supply again?**

In general there are two circumstances that will cause the power supply to shut down. The first one is the activation of the over-load-protection (OLP). To deal with this situation, we suggest increasing the rating of the output power or modifying the OLP point. The second one is the activation of over-temperature protection (OTP) when the internal temperature reaches the pre-set value. All of these conditions will let the switching power supply enter protection mode and shut down. After these conditions are removed, the switching power supply will be back to normal.

**The output ground (GND) and frame ground (FG) is the same point in my system, can ALTECH's power supplies be used in such system?**

Yes. Since our products are designed based on isolation concept, it will be no problem that the output ground (GND) and frame ground (FG) is the same point in your system. But, EMI may be affect by this connection.

**During the operation of ALTECH power supply, there is some leakage current on the case. Is this normal? Will this leakage current hurt human body?**

Due to the requirement of EMI, there will be some Y capacitors between line and neutral to the FG (case) to improve EMC. These Y capacitors will cause some leakage current flow from line or neutral to the case (normally case will be connected to earth ground). For example, IEC-60950-1 requires that this current should be less than 3.5mA for IT equipment, so basically the leakage current you find on the case will not hurt human body. Proper connection to Earth ground will solve the leakage current problem.

**What should be noticed when installing a power supply in vertical and horizontal directions?**

Most small wattage power supplies are mainly installed in the horizontal position. If you have to install it vertically because of mechanical limitation, you should consider the output derating due to the heat concern. The temperature derating curve can be found on the spec sheet.

# Frequently Asked Questions

## What is "Input - Inrush Current"? What will we notice?

At input side, there will be (1/2 ~ 1 cycle, ex. 1/120 ~ 1/60 seconds for 60 Hz AC source) large pulse current (20~60A based on the design of S.P.S.) at the moment of power on and then back to normal rating. This "Inrush Current" will appear every time you turn on the power. Although it will not damage the power supply, we suggest not turning the power supply ON/OFF very quickly within a short time. Besides, if there are several power supplies turning on at the same time, the circuit breaker of AC source may shut off and go into protection mode because of the huge inrush current. It is suggested that these power supplies start up one by one if possible.

## What is PFC?

PFC stands for Power Factor Correction. The purpose of PFC is to improve the ratio of apparent power and real power. The power factor is only 0.4~0.6 in non-PFC models. In PFC models, the power factor can reach above 0.95. The calculation formulas are as below:

Apparent Power=Input Voltage x Input Current (VA)

Real Power= Input Voltage x Input Current x Power Factor (W)

From the environment friendly point, the electric power plant needs to generate a power which is higher than apparent power in order to steadily provide electricity to the market. The real usage of electricity should be defined by real power. Assuming the power factor is 0.5, the power plant needs to produce more than 2VA to satisfy 1W real power. On the contrary, if the power factor is 0.95, the power plant only needs to generate more than 1.06VA to provide 1W real power need. It will be more effective.

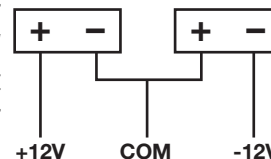

## What is the difference between -V, +V and COM which are marked on the output side? Com (COMMON) means common ground.

Single output: Positive pole (+V), Negative pole (-V)

+V; COM and -V can be attained by using two switching power supplies in series.

Example: (2x PS-S2012)

## In ALTECH's catalog, we see AC and DC at input, what is it all about?

Due to different circuit designs, ALTECH power supply's input consists of three types as below:

( $\sqrt{2}=1,414 \rightarrow 1.414 \times AC = DC$ )

A.85~264VAC;120~370VDC

B.176~264VAC;250~370VDC

C.85~132VAC/176~264VAC by Switch; 250~370VDC

- In the case of option A and B inputs models, power supply can work properly no matter under AC or DC input. Some models need correct connection of input poles, positive pole connects to AC/L; negative pole connects to AC/N. Others may require opposite connection, positive pole to AC/N; negative pole to AC/L. If customers make a wrong connection, the power supply will not be broken. You can just reverse the input poles and power supply will still work.
- In the case of option C input models, please make sure that you switch the 115/230V input correctly. If the switch is on the 115V side and the real input is 230V, the power supply will be damaged.



Subjects		IEC60950-1	IEC60601-1	
Creepage distance/ Clearance distance Working Voltage: Max. 250Vrms	Basic Insulation	2.5mm/2mm	4mm/2.5mm	
	Supplementary Insulation	5mm/4mm	8mm/5mm	
Electric Strength Test	Basic Insulation	1500Vac	1500Vac	
	Supplementary Insulation	3000Vac	4000Vac	
Leakage Current	CLASS I	Handheld: 0.75mA	—	
		Others: 3.5mA	Leakage current of grounding	0.3mA
	Leakage current of grounding		0.1mA	
	CLASS II	0.25mA	Leakage current of grounding	0.1mA
Number of Fuse		1	2	
The Lowest Ambient Temperature		Refer to the definition of Manufacturer	40°C	

**Will ALTECH's products with CE marking meet the EMC requirements after assembling into my system?**

We cannot guarantee 100% that the final system can still meet the EMC requirements. The location, wiring and grounding of the switching power supply in the system may influence its EMC characteristics. In different environment or applications, the same switching power supply may have different outcomes. Our test results are based on setup shown in the EMC report.

**What is different between information (EN60950-1) and medical (EN60601-1) safety standard?**

According to safety standard, the leakage current in EN60950-1 Class I cannot exceed 3.5mA. Many of ALTECH's power supplies meet this requirement but may not meet the EN60601-1. Others criteria like safe distance and numbers of fuse are also different. Please consult the diagram below:

# Index

<b>Part No.</b>	<b>Page</b>	<b>Part No.</b>	<b>Page</b>	<b>Part No.</b>	<b>Page</b>
AC-TEC 2403-1	199	PS-10012	84	PSA-18024	42
AC-TEC 2420-8	199	PS-10015	84	PSA-36024	44
AKKUTEC 2402	199	PS-10024	84	PSA-60024	46
AKKUTEC 2405	199	PS-12012	92	PSB-12024	50
AKKUTEC 2412	199	PS-12024	92	PSB-18024	52
AKKUTEC 2440	199	PS-12048	92	PSB-36024	54
BAT-1.2VRLA	198	PS-1505	76	PSB-60024	56
BAT-12VRLA	198	PS-1512	76	PSC-1012	10
BAT-3.4VRLA	198	PS-1515	76	PSC-1015	10
BAT-7.2VRLA	198	PS-1524	76	PSC-1024	10
BTH-1.2	198	PS-3005	78	PSC-15124	22
BTH-12	198	PS-3012	78	PSC-15148	22
BTH-3.4	198	PS-3015	78	PSC-2012	12
BTH-7.2	198	PS-3024	78	PSC-2015	12
BTM-1212	198	PS-4505	80	PSC-2024	12
BTM-123	198	PS-4512	80	PSC-24124	26
BTM-123D	198	PS-4515	80	PSC-24148	26
BTM-127	198	PS-4524	80	PSC-4012	14
BTM-127D	198	PS-6005	82	PSC-4015	14
BTM-241	198	PS-6012	82	PSC-4024	14
BTM-2412	198	PS-6015	82	PSC-4048	14
BTM-241D	198	PS-6024	82	PSC-48124	30
BTM-243	198	PS-7512	90	PSC-48148	30
BTM-243D	198	PS-7524	90	PSC-6012	16
BTM-247	198	PS-7548	90	PSC-6015	16
BTM-247D	198	PS-C12012	116	PSC-6024	16
C-TEC 2403-1	199	PS-C12024	116	PSC-6048	16
C-TEC 2405-5	199	PS-C12048	116	PSC-9612	18
C-TEC 2410-10	199	PS-C24024	118	PSC-9615	18
C-TEC 2420-8	199	PS-C24048	118	PSC-9624	18
C-TEC 2440-4P	199	PS-C48024	120	PSC-9648	18
CB1210A	176	PS-C48048	120	PSH-12024	94
CB12245A	188	PS-C480P24	122	PSH-12048	94
CB1235A	178	PS-C480P48	122	PSP-24024	96
CB123A	172	PS-RDN20	34	PSP-44048	96
CB126A	174	PS-RDN20	194	PSP-48024	100
CB2410A	184	PS-S10012	70	PSP-48048	100
CB2420A	186	PS-S10024	70	PSP-480S24	102
CB243A	180	PS-S10048	70	PSP-480S48	102
CB245A	182	PS-S1005	62	PST-24024	106
CBI1210A	146	PS-S1012	62	PST-24048	106
CBI1235A	148	PS-S1015	62	PST-48024	108
CBI123A	142	PS-S1024	62	PST-48048	108
CBI126A	144	PS-S2005	64	PST-96024	110
CBI2410A	154	PS-S2012	64	PST-96048	110
CBI2420A	156	PS-S2015	64	PST-960P24	110
CBI243A	150	PS-S2024	64	PST-960P48	110
CBI245A	152	PS-S4005	66	PSW-12012	128
CBI2801224A	164	PS-S4012	66	PSW-12024	128
CBI2801224B	166	PS-S4024	66	PSW-12048	128
CBI2803648A	162	PS-S4048	66	PSW-24024	130
CBI4810A	160	PS-S6005	68	PSW-24048	130
CBI485A	158	PS-S6012	68	PSW-48024	132
CEM 1	199	PS-S6024	68	PSW-48048	132
CEM 16	199	PS-S6048	68		
CEM 2	199	PS-UPS40	196		
CEM 8	199	PSA-12024	40		

All of your

# Altech® POWER SUPPLY

Information Online

visit ...

[www.altechcorp.com/POWER](http://www.altechcorp.com/POWER)



PHOTOS

- Specification sheet
- Product Photo
- Drawing - DWG format
- Drawing - DXF format
- Drawing - PDF format
- Drawing Top View - DWG format
- Drawing Top View - DXF format
- 3D CAD-Drawing - STEP format

## SPECIFICATION SHEETS

Model No.	Power	Voltage	Current
PSW-120-1	120W	5V	24A
PSW-120-2	120W	12V	10A
PSW-120-3	120W	15V	8A
PSW-120-4	120W	24V	5A

**DWG / DXF / 3D CAD files**

Model No.	Power	Voltage	Current
PS-520-1	520W	5V	104A
PS-520-2	520W	12V	43.3A
PS-520-3	520W	15V	34.7A
PS-520-4	520W	24V	21.7A

# Terms and Conditions

**TITLE** - Title to the products of ALTECH shall remain with ALTECH until payment is made in full by Customer. Such reservation of title is for the purpose of securing the purchase price and shall not relieve Customer of the duty to inspect the products upon receipt, to notify ALTECH of any deficiencies or defects, and to exercise due care in the use, installation, operation, and maintenance of the products when on the premise of the Customer or under the control of the Customer. Notwithstanding any reservation of title by ALTECH, risk of loss shall pass to customer at any time of shipment.

**SHIPMENT AND DELIVERY** - All orders for destination in the mainland United States (less Hawaii, Alaska and non-continental United States possessions) will be shipped F.O.B. Flemington, N.J. All destination, shipping and other charges shall be paid by the Customer in accordance with ALTECH's then current shipping and billing practices.

Delivery dates given in the acceptance of any order are approximate. ALTECH shall not be liable for delays in delivery or in performance due to causes beyond its reasonable control including acts of God, acts of Customer, acts of civil or military authority, fires, strikes or other labor disturbances, war, riot or delays in transportation. In the event of such delay, the date of delivery or performance shall be extended for a period equal to the time lost by reason of the delay.

**PRICE** - PRICES in any ALTECH publication are subject to change without prior notification. Catalog prices are based on prices published in the current price list. All written quotations are valid for thirty (30) days from the date of quotation. Customer shall pay all sales, use, excise or similar taxes whenever ALTECH must itself pay and/or collect such tax from Customer arising out of the sale.

**PAYMENT** - Customer agrees to make payment within thirty (30) days of date of the invoice from ALTECH. Customer agrees to pay a late payment charge of one and one-half percent (1.5% per month, or the maximum late payment charge permitted by applicable law, whichever is less, on any unpaid amount for each calendar month (or fraction thereof) that such payment is in default. Orders amounting to less than \$100.00 will be billed at \$100.00 plus freight. Full carton purchases are required. In the event of referral to an attorney for collection, reasonable attorney's fees for collection of the overdue amount shall be paid by Customer. In the event payment is not received within 30 days from the date of invoice, any discount shall be cancelled and the full list price will be due.

**LIMITED WARRANTY** - ALTECH warrants to Customer that the equipment purchases shall be free from defects in material and workmanship under normal use and service for a period of one year from shipment.

Written notice as an explanation of the circumstances of any claim that the equipment has proved defective in material or workmanship shall be given promptly by the Customer to ALTECH.

ALTECH will not be liable for any misuse, improper operations, improper installation, improper maintenance, alteration, modification, accident or unusual degradation of the equipment or parts due to an unsuitable installation environment.

No representation of other affirmation of facts, including but not limited to statements regarding capacity, suitability for use or performance of the equipment, shall be or be deemed to be a warranty or representation by ALTECH for any purpose, nor give rise to any liability or obligation of ALTECH whatsoever.

Customer's sole and exclusive remedy in the event of breach of warranty, as set forth herein, is expressly limited to (1) the correction of the defect by adjustment, repair, modification, or replacement, or (2) issuance of a credit or refund of the purchase price for the defective equipment at ALTECH's election and sole expense.

EXCEPT AS SPECIFICALLY PROVIDED IN THIS AGREEMENT, THERE ARE NO OTHER WARRANTIES EXPRESSED OR IMPLIED INCLUDING BUT NOT LIMITED TO ANY IMPLIED WARRANTIES OR MERCHANTABILITY OR FITNESS FOR A PARTICULAR PURPOSE.

THIS WARRANTY EXTENDS ONLY TO THE CUSTOMER FROM ALTECH OR ITS AUTHORIZED DISTRIBUTOR.

**LIMITATION OF LIABILITY** - IN NO EVENT, SHALL ALTECH BE LIABLE FOR LOSS OF PROFITS, INDIRECT, SPECIAL, CONSEQUENTIAL OR OTHER SIMILAR DAMAGES ARISING OUT OF ANY BREACH OF THIS AGREEMENT OR OBLIGATIONS UNDER THE AGREEMENT.

ALTECH SHALL NOT BE LIABLE FOR ANY DAMAGES CAUSED BY DELAY IN SHIPMENT, INSTALLATION OR FURNISHING OF EQUIPMENT OR SERVICES UNDER THIS AGREEMENT.

No action arising out of any claimed breach of this Agreement may be brought by either party more than two (2) years after the cause of action has accrued.

**PATENT INDEMNITY** - ALTECH shall defend or settle any suit or proceeding brought against Customer based on a claim that any equipment made to ALTECH design and furnished hereunder constitutes an infringement of any existing United States patent, provided (ALTECH) is notified promptly in writing and is given complete authorization and information required for the defense, and ALTECH shall pay all damages and costs awarded against Customer, but shall not be responsible for any costs, expense or compromise incurred or made by Customer without ALTECH's prior written consent. If any equipment is in ALTECH's opinion likely to or does become the subject of a claim for patent infringement, ALTECH may at its option and expense procure for Customer the right to continue using the device, modify it to become non-infringing, but in the event ALTECH is not reasonably able to modify, substitute, or otherwise procure for Customer the right to continue using it, ALTECH will remove such equipment and refund to Customer the amount paid in excess of a reasonable rental for past use.

ALTECH shall not be liable for any infringement or claim based upon use of the equipment in combination with other equipment not supplied by ALTECH or with modifications made by Customer.

The foregoing states the entire liability of ALTECH to Customer arising from patent infringement.

**SELLER'S REMEDIES** - Should Customer fail to make any payment within ten (10) days of its due date, or fail to perform any other of the Customer's obligation hereunder upon thirty (30) days written notice, or should Customer be or become insolvent or be a party to any bankruptcy receivership proceeding prior to full payment of all amounts payable hereunder, ALTECH may: (a) with or without demand or notice to customer declare the entire amount unpaid immediately due and payable; (b) enter upon the premises where the equipment may be found and remove it (Customer shall assemble the equipment and make it available to ALTECH at a place reasonably convenient to both parties and shall permit and assist ALTECH in effecting the retaking and removal of the equipment); and (c) sell any or all the equipment as permitted under applicable law, applying the proceeds of the sale to payment of the expenses of retaking, repairing and selling the equipment, reasonable attorney fees and to the satisfaction of all indebtedness then due and unpaid under this Agreement. Any surplus shall be paid to Customer and any deficiency shall be paid to ALTECH by Customer.

The remedies provided herein shall be cumulative and in addition to all other remedies provided by law or equity or under the Uniform Commercial Code.

**GOVERNING LAW** - This agreement will be governed by the Laws of the State of New Jersey.

**GENERAL** - This Agreement shall only become effective and binding when either (a) it has been accepted and executed by an authorized representative of ALTECH, or (b) the equipment has been shipped to Customer, with or without acceptance in writing hereon. Notice of acceptance is hereby waived by Customer. Customer hereby acknowledges receipt of a true and complete copy hereof.

No addition to or modification of any of the Terms and Conditions of Sale as they appear herein shall be binding upon ALTECH unless signed in writing by duly authorized representative of ALTECH in Flemington, N.J.

Typographical and clerical errors in quotations, orders and acknowledgments are subject to correction.

This Agreement is not assignable without the prior written consent of ALTECH. Any attempt to assign any of the rights, duties or obligations of this Agreement without such consent is void.

If any provision or provisions of this Agreement shall be held to be invalid, illegal or unenforceable, the validity, legality and enforceability, of the remaining provisions shall not in any way be affected or impaired thereby.

ALTECH is not responsible for failure to fulfill its obligation under this Agreement due to causes beyond its control, or except as agreed herein.

THE CUSTOMER ACKNOWLEDGES THAT HE HAS READ THE AGREEMENT, UNDERSTANDS IT, AND AGREES TO BE BOUND BY ITS TERMS AND CONDITIONS. FURTHERMORE, THE CUSTOMER AGREES THAT IT IS THE COMPLETE AND EXCLUSIVE STATEMENT OF THE AGREEMENT BETWEEN THE PARTIES, WHICH SUPERSEDES ALL PROPOSALS OR PRIOR AGREEMENTS, ORAL OR WRITTEN, EXPRESSED OR IMPLIED, AND ALL OTHER COMMUNICATIONS BETWEEN THE PARTIES RELATING TO THE SUBJECT MATTER OF THIS AGREEMENT.



## Here are other great products available from Altech!

### Universal Power Distribution Systems



Altech Corp's new catalog features various innovative ways to distribute power in your panel.

- Well known UL508 busbars in two sizes and ratings up to 200A/480V AC
- Introducing the UL489 recognized busbar for Altech's line of Miniature Molded Case Circuit Breakers with an industry leading rating of 115A/480V AC
- New ADP distribution system utilizing 0.25 quick-connects
- Extended power distribution block line

### Interface Modules & Industrial Relays



Altech offers a wide range of DIN Rail or panel mount cable interface modules, relay interface modules, power supplies, carrier modules, and custom designed modules. Cable to connector models include: D-Sub connectors, ribbon cable connectors, and Dip socket connectors to terminals. Standard relay modules from 1 to 16 channels, and safety relay modules from 1 to 16 channels and up to 10 poles are included. The catalog also contains a large selection of industrial relays, and custom designed interface modules.

### Terminal Blocks



Altech offers a NEW Terminal Block catalog with the most competitively priced blocks in the industry. We feature screw and spring clamp models for DIN rail and panel mount applications. This advanced line of wire termination products will increase your design options and help to get the job done more efficiently. Our line of blocks include feed-through (single, double or triple level), distribution, ground, fuse, disconnect, thermocouple, surge suppressor and indicator. A wide variety of accessories, tools and ferrules are available.

### Liquid Tight Strain Reliefs



This 64-page catalog introduces Altech's full line Liquid Tight Strain Reliefs (Cord Grips) which are used to seal cable entries, keep contaminants from entering enclosures, provide strain relief and thus reduce stress on components and termination points inside enclosures. Available in standard, high-performance, and economy versions, functions include Straight-Through, Increased Strain Relief, Bend Protection, Pull/Bend Protection, Multi-conductor, Flat Cable and EMI/RFI. They can be used with almost any type of cable, cord or conductor - solid, stranded, flat, shielded, high temperature, etc.

### Industrial Enclosures



Altech's expanded line of TK Industrial Enclosures, with metric knockouts, is here. Now our entire line of industrial enclosures is in metric. Metric knockouts align with international standards making selection easier and more universal. Plus the PG standard is still available. All of Altech's enclosures are internationally accepted and stand up to the harshest environments. They protect against dust, water and corrosion while enhancing the value of your product. Rated up to IP66 (NEMA type 4x), Altech enclosures are available in a wide range of sizes.

### Motor Disconnect Switches



Altech's line of Motor Disconnect Switches are UL 508 listed as Manual Motor Controllers for AC Motor Starting Across-the-line and AC General use. This new 16 page catalog includes the 3 different handle designs, which are all available in gray/black or yellow/red housings. Electrical ratings are 25-150A / 600V. The switches are non-fused DIN Rail mountable. Neat features include: snap-on auxiliary switches, door mounting kit and a retrofit 30A fuse holder. Also featured are Enclosed Motor Disconnect Switches & Fused Enclosed Motor Disconnect Switch (30A) in plastic or stainless housings.



### Altech Search

Google



- Home
- Stock Check
- Distributors
- Information
- News
- Contact
- Rep/Dist/ LogIn
- Altech Mexico

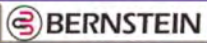

#### WEB TOOLS

- Product Crossings
- Request for Quote
- Sample Request
- Catalog Request

#### eBook Catalog

#### PRODUCT MENU

- Accessories
- Bernstein Line
- Circuit Protection / Control
- Connectors
- Enclosures
- European Spare Parts
- Digital Panel Meters
- Foot Switches
- Interface Modules
- Panel Accessories
- Power Supplies
- Power Semi-Conductors
- Programmable Controllers
- Push Buttons & Pilot Lights
- Relays
- Sensors
- Terminal Blocks
- Tower Lights
- Timers
- Wire & Cable Management
- Home

### New Products and Promotions

## Serving the Automation & Control Industry Since 1984

#### Circuit Protection



Circuit Protection Devices



Busbar and Power Distribution



Contactors, Overload Relays, Manual Motor Starters



Motor Disconnect Switches



European Fuses

#### Connectors



Industrial Rectangular Connectors



Pin & Sleeve Devices



Receptacles



Foot Switches



Inductive Proximity Sensors

#### Enclosures



Industrial Enclosures



DIN Enclosures

#### Modules & Relays



Interface Modules



Safety Relays



Slimline Relays

#### Power Supplies



Power Supplies



22 & 30 mm Push Buttons

#### DIN Rail



DIN Rail

#### Wire & Cable Management



Liquid Tight Strain Reliefs/Corrugated Tubes



Wire Duct

#### Terminal Blocks



Din Rail Terminal Blocks



Panel Mount Terminal Blocks



Printed Circuit Board Terminal Blocks



Eurostrips®



Distribution Blocks

#### Miscellaneous



Ferrules

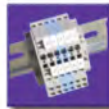

Custom Assembly



Marking & Engraving Systems



Altech Smart Relay



Tower Lights



Altech® NEWS

Altech Corporation  
35 Royal Road  
Flemington, NJ 08822-6000  
P 908.806.9400 • F 908.806.9490  
www.altechcorp.com  
Altech Corp.® 755B-112014-5M  
Printed November 2014

