

■ Cabinet Solutions

LÜTZE LSC Wiring System

Reaching new heights in automation

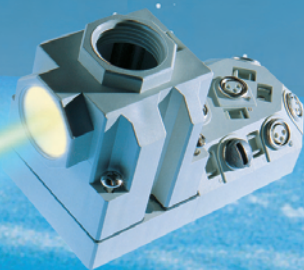

Contents:

1. General Information	Page 4 - 7
2. Designs	
2.1 LSC-BRACKET	Page 8
2.2 LSC-COMPACT	Page 9
2.3 LSC-DISTANCE and LSC-ALPHA	Page 10
3. Mounting	
3.1-3.3 Fastening in the control cabinet: LSC-BRACKET, LSC-COMPACT and LSC-DISTANCE	Page 11 - 12
3.4 Compatibility	Page 12
3.5 Mounting of the components on the frame	Page 13
3.6 Mounting rails	Page 14 - 15
3.7 Support rails	Page 16
3.8 Brackets	Page 17
3.9 Side supports	Page 17
4. Wiring accessories:	
4.1 Wiring combs and covers	Page 18
5. Accessories	
5.1-5.3 Mounting aids	Page 19 - 22
6. EMC accessories	Page 23 - 26
7. Technical information	
7.1 Wiring information	Page 27
7.2 LSC in the vibration and shock test	Page 28
7.3 Proof of conductivity	Page 28
7.4 Specification of the mounting rail length	Page 29
7.5 LSC-BRACKET: Bracket installation situation	Page 29
7.6 Installation depth	Page 29
7.7 Side support installation situation	Page 30
7.8 Materials	Page 30
7.9 - 7.11 Current capacity, torques and weights	Page 31
7.12 Ordering information	Page 32
8. Application examples	Page 33 - 34



Installation Solutions



Cabinet Solutions

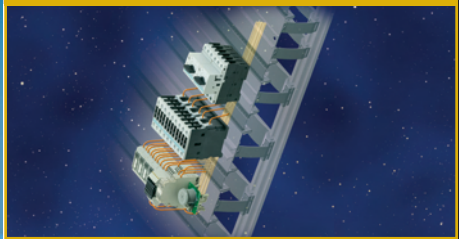

Automation Solutions



OEM Solutions



Transportation Solutions



LÜTZE has been developing and manufacturing electronic and electrical engineering solutions for controls and installations for more than 50 years.

Our basic concept as system suppliers providing a comprehensive and well-match product range with which we can generate innovative and customised solutions has stood the test of time.

The LSC system for cabinet wiring has been available since 1972. In the decades since then, numerous users have optimised their control cabinets in respect of space, time and cost. The close relationship between product development and the customer has had a special role to play. As with all the Lütze product ranges, this has allowed the implementation of continuous market-orientated improvements and developments.

Lütze systems comply with the highest industrial standards, Lütze solutions mean improvement and innovation.

For more information on our products, please visit www.luetze.com.



Systematic Technology

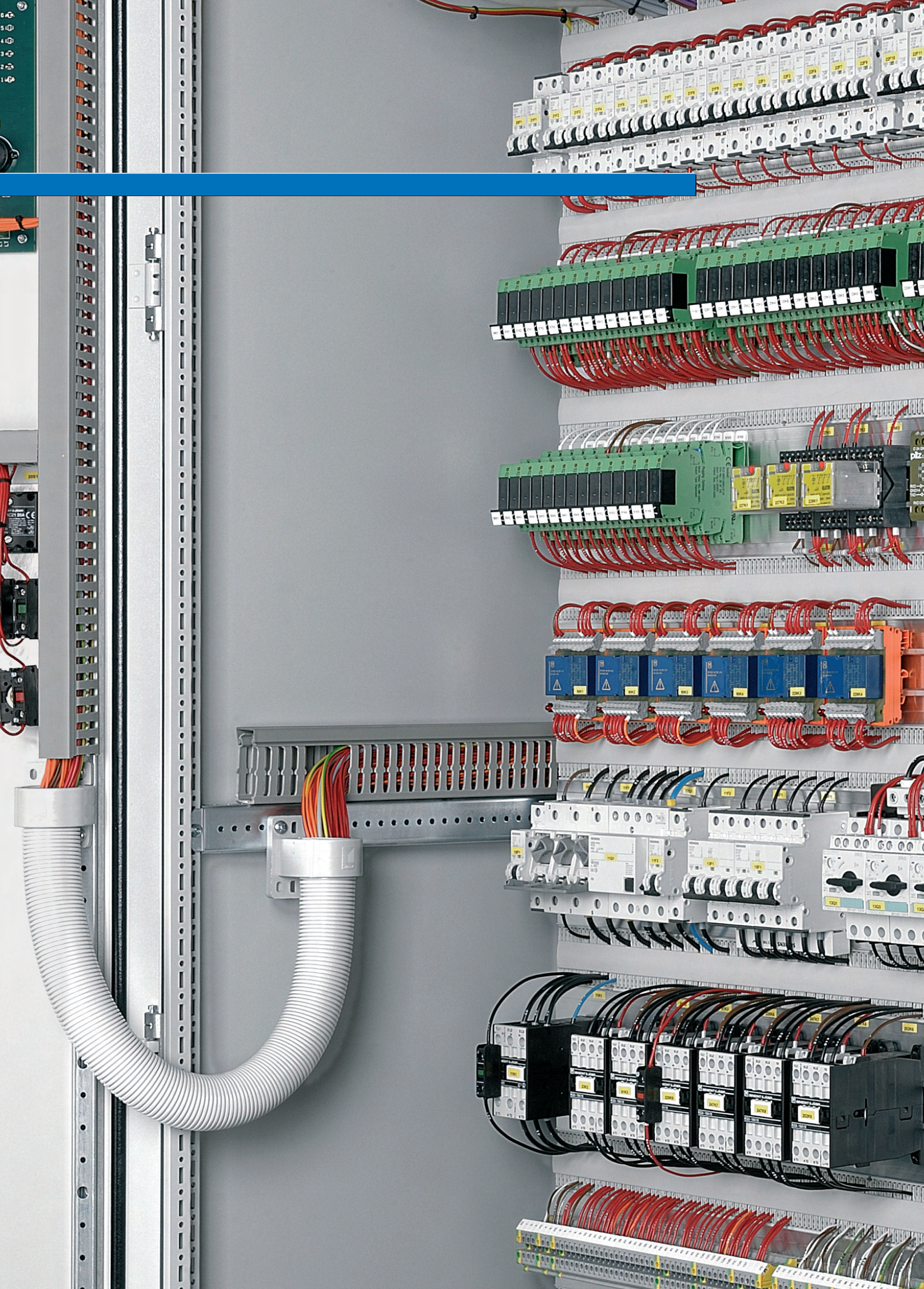

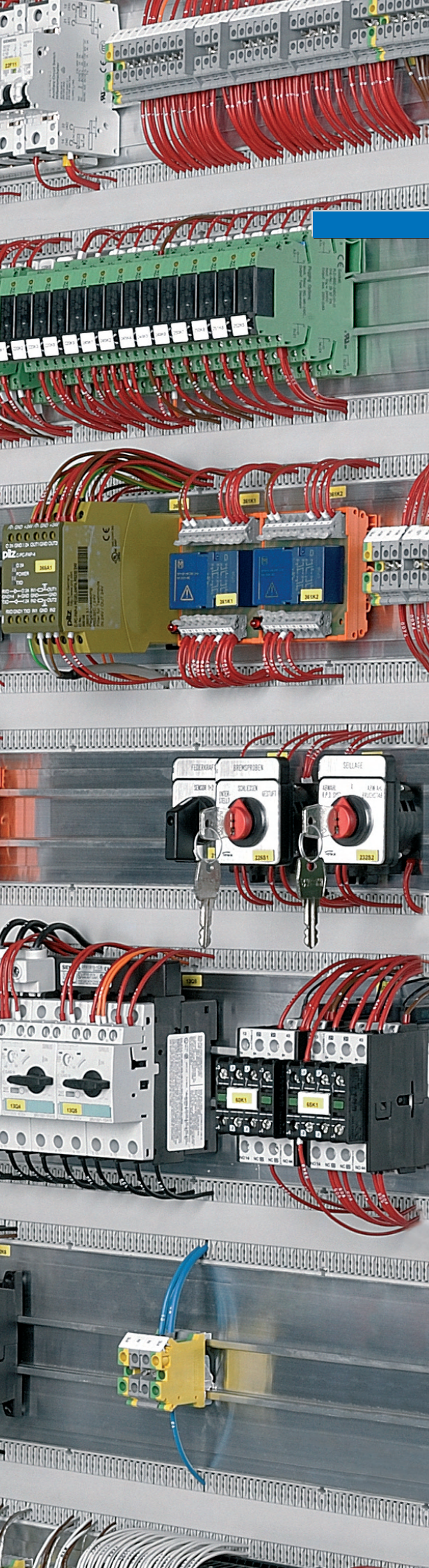

LSC at a glance

LSC system advantages

Effective use of space

The LSC wiring system allows considerable reduction in the size of control cabinets. This allows minimisation of the productive area and the costs involved.

Accessible from the front

Lütze's ready-made LSC frames are installed instead of the mounting panel. Component fitting and wiring take place from the front. The frames are constructed in such a way that wiring running behind the rails can be accessed from the front at any time.

Systematic flexibility

The range of aluminium profiles allows adaptation to almost any control component. The modular frame construction leaves nothing to chance.

Perfect climate

The separation into mounting and a wiring planes means that air can freely circulate around the components and wires, allowing for heat to dissipate and be carried away, less cooling is required and resources are protected.

LSC - the environmentally-friendly solution





Aluminium at an advantage

LÜTZE-LSC - an ecological and economical hit

LSC protects the environment

Independent studies, e.g. that of the WHT Institute, have clearly shown the ecological strengths of the material of the LSC wiring system: In all the tests carried out, the LÜTZE aluminium system was able to deal far better with any environmental loads through out its lifespan than a control cabinet structure with a steel mounting panel.

LSC - Quality which pays

An economic comparison produces equally clear results. An LSC wiring frame increases system availability. This can make real savings. In addition, the reuse of an LSC wiring frame means lower costs for retrofitting or refitting.

LSC with a good operating climate

Air can circulate freely, heat dissipates rapidly. The result: reduced cooling power required and thus energy savings, helping our environment.

Lütze's commitment to the environment

For LÜTZE, this is one of many design challenges. In this way, we can continually improve our processes and products, for example with Eco-Audits, in order to reduce the environment impact of production - supported by the motivation of the employees.



Systematic Technology

2. Designs

2.1 LSC-BRACKET

With the **LSC-BRACKET** system, the mounting rails are attached to the support rails using brackets. The rails are used to accept the control system components. The brackets help to provide additional space to accept the wiring plane and also offer optimum wiring, even in the case of re-wiring or rapid troubleshooting during servicing, and ensure a stable structure. The loose, vertical cable runs in the brackets, means that each wire can easily be traced.

With the **LSC-BRACKET** system, emphasis was placed on the most economic use of space in the control cabinet or control box. The special feature of the BRACKET design of the LSC system is that the entire wiring and any repair and expansion work, despite routing on two planes, can be carried out from the front, as required in EN 60204 and VDE 0113. It is therefore not necessary to open the rear panel of the control cabinet.

Due to the large volume of cables, wiring can be carried out with pre-terminated single wires. This saves time and thus money. In addition, productivity is achieved for individual production as if it were actually series production. Depending on the design of the production options, the **LSC-BRACKET** frame can also be equipped and wired externally.

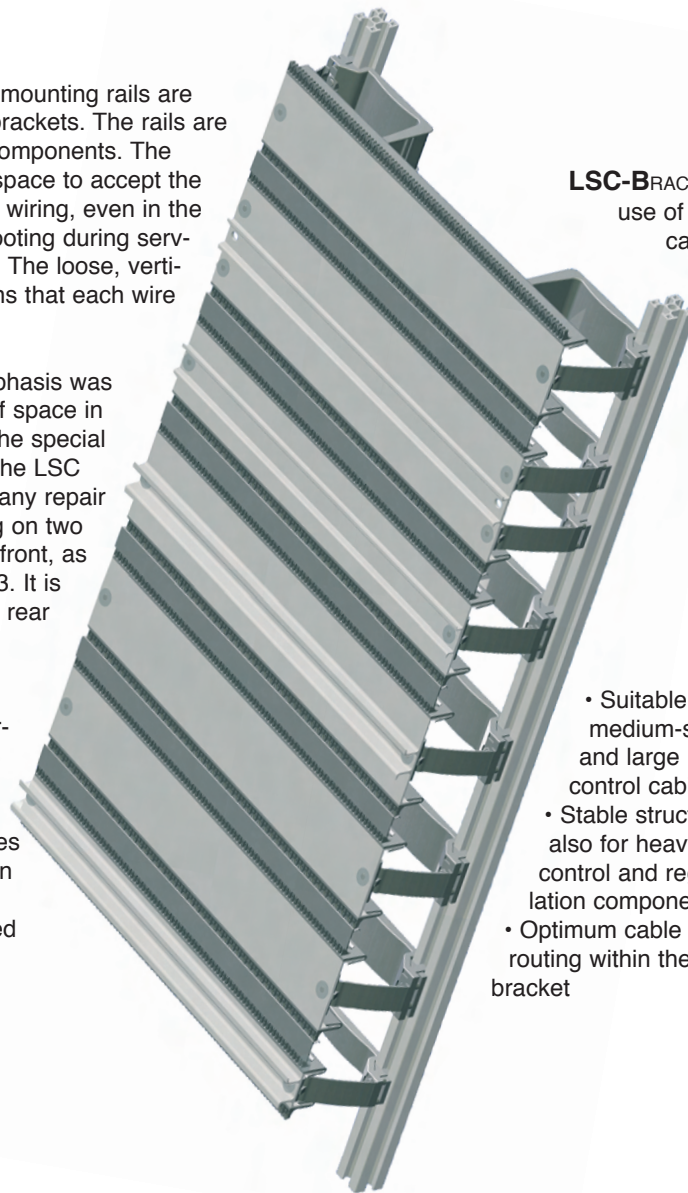

LSC-BRACKET: Most economic use of space in the control cabinet, mounting and wiring on two planes with front access direction

- Suitable for medium-sized and large control cabinets
- Stable structure also for heavy control and regulation components
- Optimum cable routing within the bracket

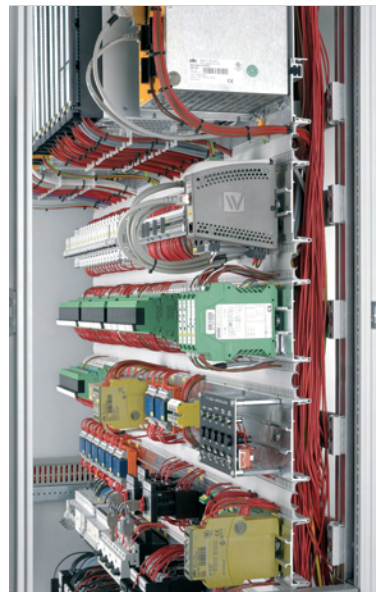
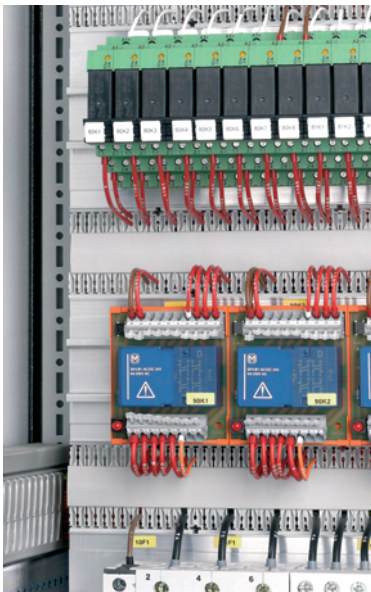

For information cabling routing and wiring, see the Chapter **Technical Information** at the end of this catalogue

2. Designs

2.2 LSC-COMPACT

- Optimum use of space for medium-sized and smaller control cabinets
- Low construction height
- Very light design with greatest stability

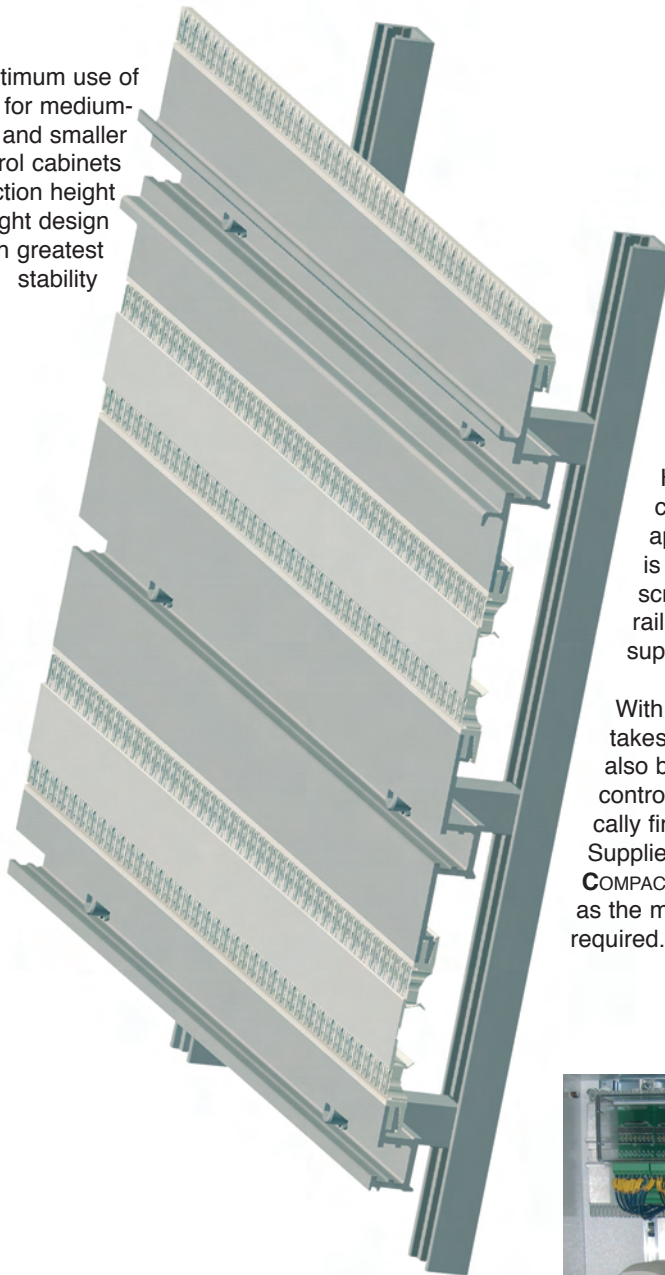

LSC-COMPACT

The smaller, lighter design of the Lütze wiring system is called

LSC-COMPACT.

Here too, the philosophy of economical use of space in a control housing applies. The space for the wiring plane is gained using side supports, which are screw tight to the mounting rails, the rails for the control components and the support rail.

With the **LSC-COMPACT** too, wiring only takes place from the front. The frame can also be equipped and wired outside the control cabinet and in be inserted in a practically finished state.

Supplied adapter plates allow the **LSC-COMPACT** to be fastened to the same points as the mounting plate, which is no longer required.

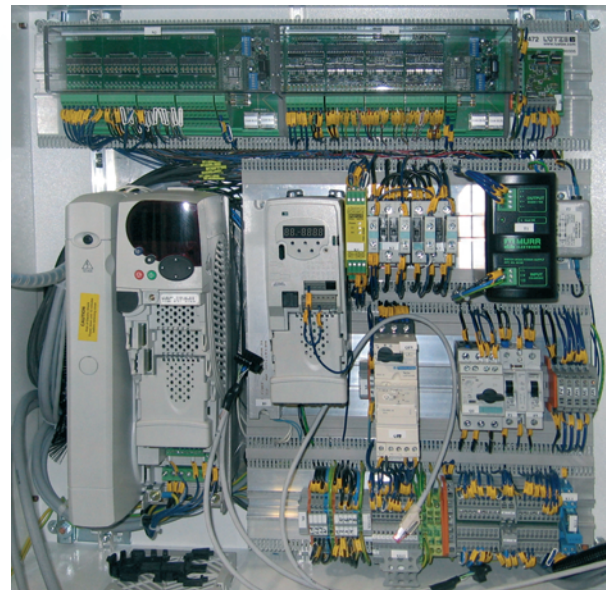

For information cabling routing and wiring, see the Chapter **Technical Information** at the end of this catalogue

2. Designs

2.3 LSC-DISTANCE, LSC-ALPHA

LSC-DISTANCE

Make two into one: the advantages of the stable version of the rails for the **LSC-ALPHA** and **LSC-BRACKET** frames, combined with the lighter design from the **LSC-COMPACT** product range. As the space for the rear wiring compartment is created using 50 mm high supports, the LSC-DISTANCE system does not require brackets. The system can be used in any cabinets/modular cabinets and, due to the fastening, in the rear cabinet position, has sufficient depth, for frequency converters.

With the **LSC-DISTANCE** system, wires and cables are run on the rear side, fixed to wiring profiles and connected on the front side. The wiring paths are defined exactly (no X wiring). In the rear area, vertical wiring is run to the left and the right of the side supports, with horizontal wiring in comb profiles between the rails. Here too, the rail spacing is aligned to the widths of the covers used. With the **LSC-DISTANCE** system, access from the rear side is not necessary!

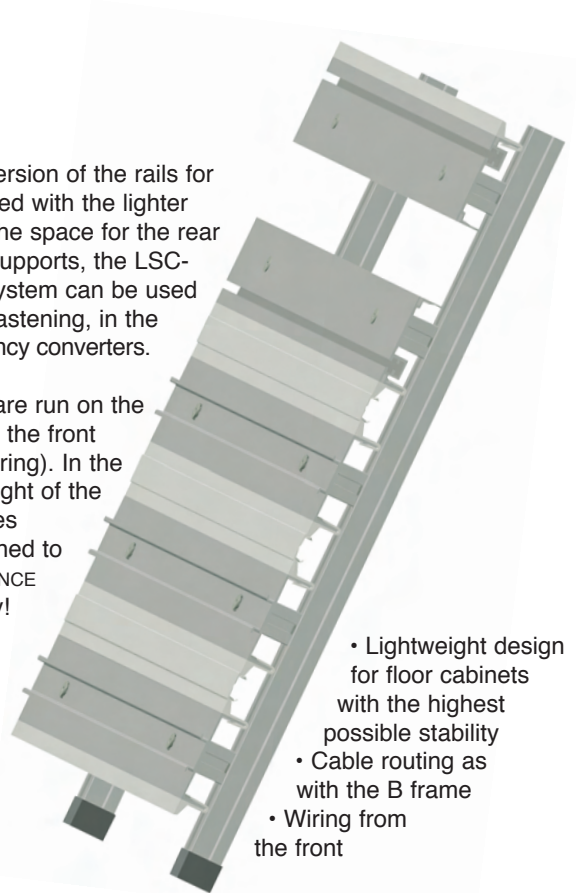

- Lightweight design for floor cabinets with the highest possible stability
- Cable routing as with the B frame
- Wiring from the front

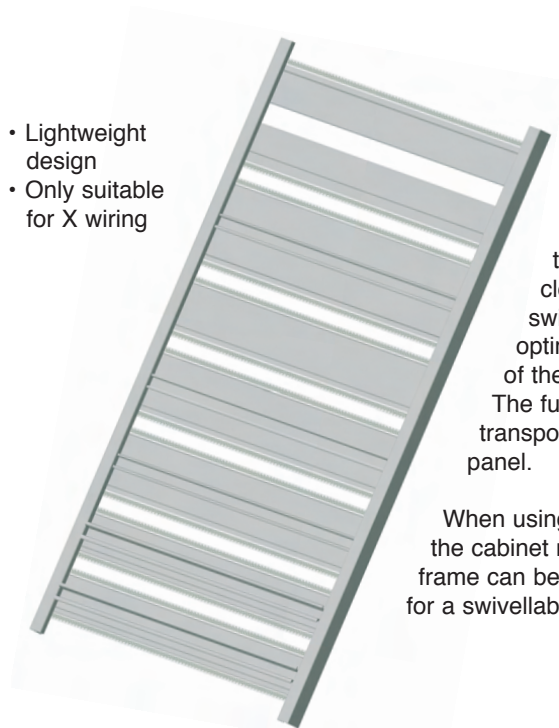

- Lightweight design
- Only suitable for X wiring

LSC-ALPHA

The original shape of an LSC frame: the ALPHA design. This frame design is completely closed and requires X wiring. The area for the switching and control elements can be used to the optimum, as the LSC frame uses the entire internal width of the control cabinet.

The fully aluminium structure means that the handling and transport weight is reduced to a third of that of a mounting panel.

When using an **LSC-ALPHA** frame, it should be noted that the cabinet must be accessible from the front and the rear, or the frame can be swivelled as a single entity. Lütze can offer solutions for a swivellable variant.

For information cabling routing and wiring, see the Chapter **Technical Information** at the end of this catalogue

3. Mounting

3.1 Fastening of the LSC-BRACKET frame in the control cabinet



Installation of the LSC frame in the rearmost position with adapting brackets.

For additional information, see Chapter 7.4



Installation using adapting rails for different position planes. The aids shown are designed for the TS8 cabinet series. Installation aids for other cabinet manufacturers on request.

3.2 Fastening of the LSC-COMPACT frame in the control cabinet

There are suitable installation kits for practically every housing available on the market.

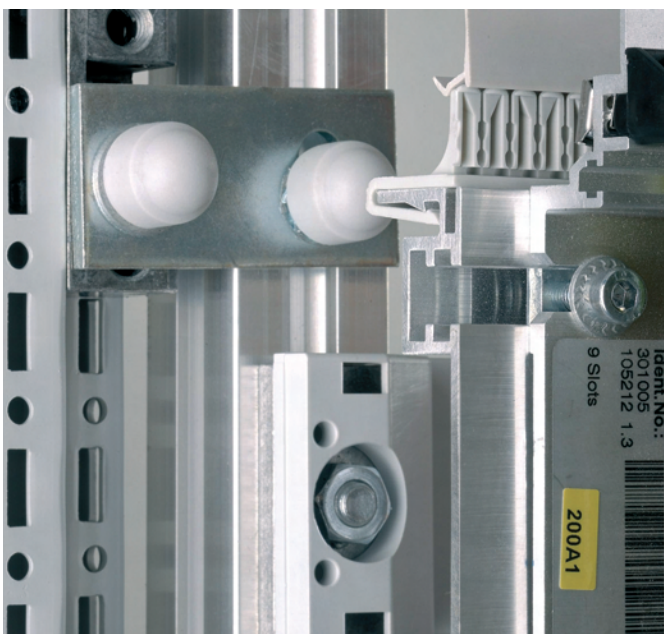

Installation situation, LSC-BRACKET frame



Installation situation in the CM housing

3. Mounting

3.3 Fastening of the LSC-DISTANCE frame in the control cabinet

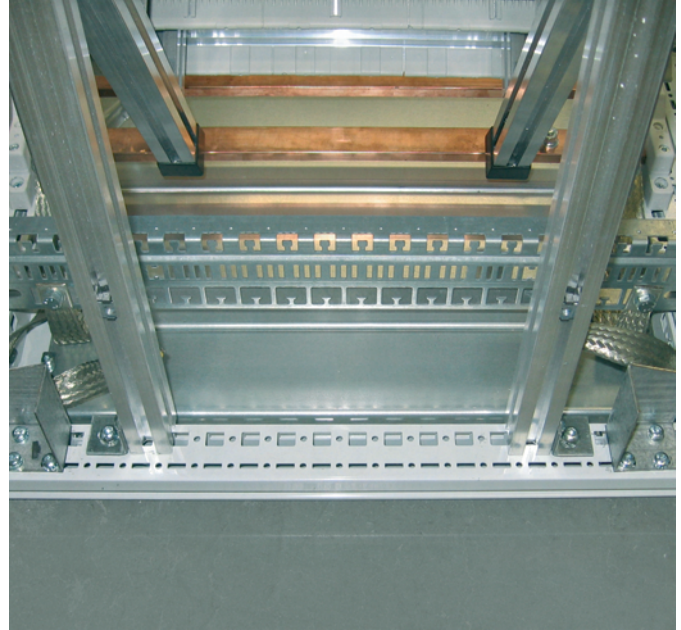
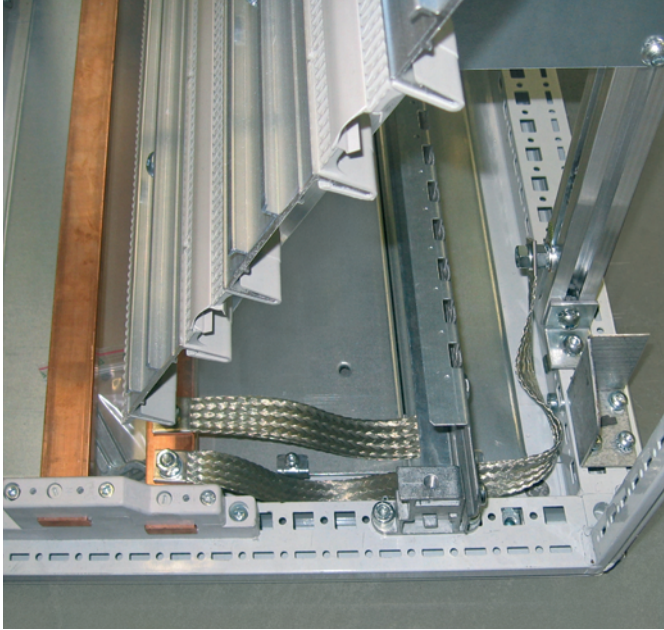

Installation situation in the TS8 cabinet (make Rittal) - fastening of the LSC-Distance frame on mounting brackets

3.4 Compatibility

There are suitable installation kits for practically every housing available on the market.

The LÜTZE LSC wiring system is compatible with the manufacturer-specific adaptations to all standard control cabinets.

Of course, the specialist LÜTZE LSC team is available for consultation and support, should you have queries on installation.



3. Mounting

3.5 Mounting of the components on the frame

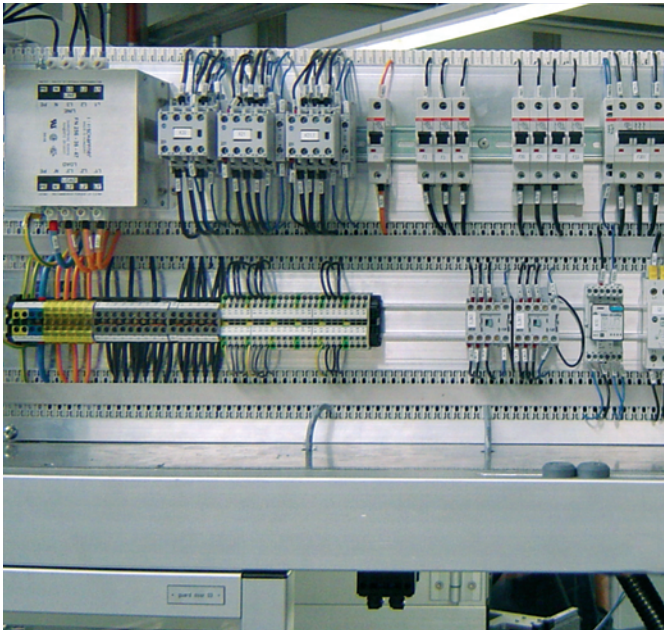

With classic hat rail applications, the rail widths can be adjusted for the appropriate switching components.

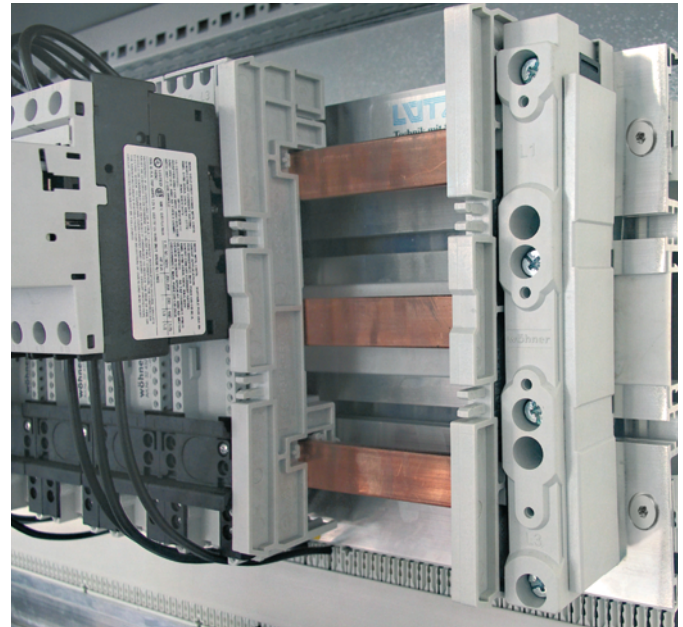

The use of rails with glide nut grooves allow easy, lost cost housing of components in the cabinet. Fig. current rail system.



If components have to be mounted over multiple rails but without a locking foot in the area of the hat rails, then hat rail adapters and adapter rails can be of use here. The two articles make any form of mounting possible.



RG rail with slots for free mounting without drilling.

3. Mounting

3.6 Mounting rails

Usable with LSC-ALPHA, LSC-BRACKET and LSC-DISTANCE

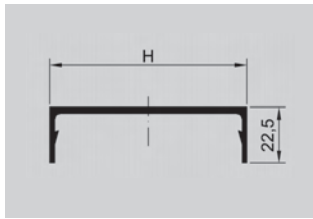

Type	Mounting rail M					
Use	Mounting rail with smooth surface for components of different sizes with screw fastening. Any size of mounting area possible by arranging multiple M rails.					
Rail widths H (mm)	20	40	60	80	100	120
Profile art. no.	346105 ²	346100 ²	346101 ²	346102 ²	346103 ²	346104 ²

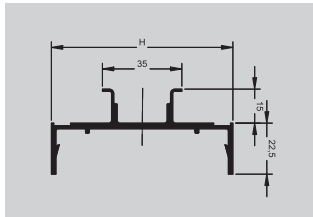

Type	Mounting rail S'				
Use	Mounting rail with high hat rail, 15 mm height, according to DIN/EN 60715. The hat rail is used to lock on any kind of controller elements.				
Rail widths H (mm)	40	60	80	100	120
Profile art. no.	330218 ²	330248 ²	330278 ²	330308 ²	330338 ²

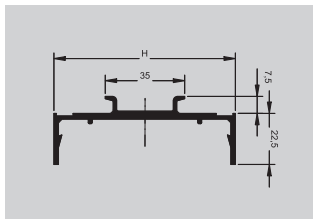

Type	Mounting rail SN'					
Use	Mounting rail with low hat rail, 7.5 mm height, to DIN/EN 60715.					
Rail widths H (mm)	40	60	80	100	120	160
Profile art. no.	330258 ²	330348 ²	330478 ²	330488 ²	330498 ²	330738 ²

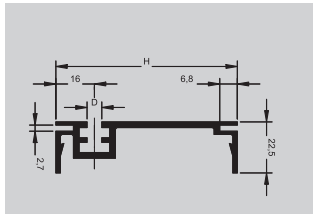

Type	Mounting rail MF					
Use	Mounting rail with smooth surface and integrated for slide nuts, M3-M8. The large area permits the mounting of all kinds of large components. With front-side groove to accept OSO plates for rear covering of common rail systems.					
Rail widths H (mm)	80					
Profile art. no.	330428 ²					

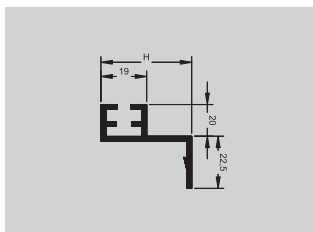

Type	Mounting rail F				
Use	Mounting rail only to accept glide nuts M3 - M8. The rail, with its possible rail widths, can also be used as a cable support rail.				
Rail widths H (mm)	30	40			
Profile art. no.	330358 ²	330368 ²			

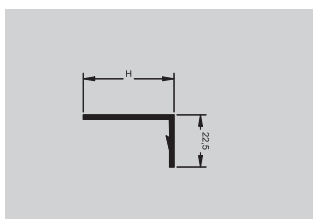
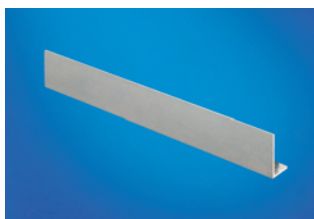

Type	Mounting rail A				
Use	Rail to attach wiring combs as possible termination of a frame.				
Rail widths H (mm)	23	40			
Profile art. no.	330398 ²	330978 ²			

Profile article number	LSC type A/B/C/D	Stock length or individual length in mm	Our stock lengths for LSC-BRACKET	521	721	921	1121	488	688	888	1088
-------------------------------	-------------------------	--	--	-----	-----	-----	------	-----	-----	-----	------

346101	B	0721	The order number of the rails contains the profile article number, LSC type and length (stock length or individual length)
--------	---	------	--

¹ Rails are fitted with a labelling groove for signs from Lütze (art. no. 631032) and Phoenix (art. no. 0806932).

² For ordering information, see the end of the catalogue.

3. Mounting

Usable for the LSC-COMPACT system

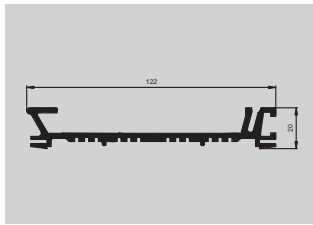
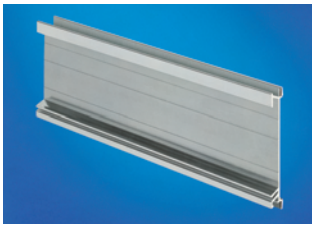

Type	ET 120
Use	Special profile for direct installation of the Siemens controller S7-300 with option of locking on the comb profiles CKP 300 and CKP 301/4
Rail widths H (mm)	122
Article number	3460952

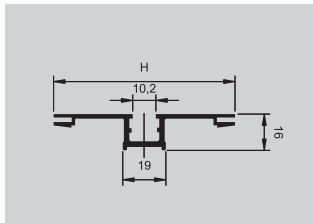
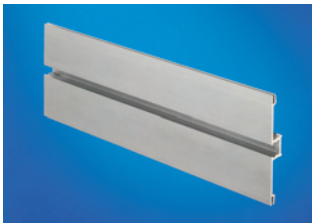

Type	Mounting rail CM
Use	Mounting rail with smooth surface and recessed groove in the centre. This groove can be fitted with M3 - M8 nuts to fasten any components. Arranging multiple rails next to each other allows the creation of any possible area.
Rail widths H (mm)	40 60 80 100
Article number	3322002 3322102 3322202 3322302

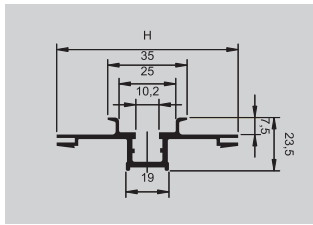
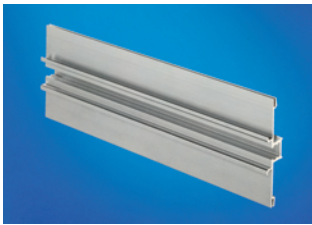

Type	Mounting rail CS
Use	Mounting rail with low hat rail, 7.5 mm, according to DIN/EN 60715 and groove for groove nut in the centre of the hat rail. This combination of hat rail and groove for general fastenings with groove nuts allows all kinds of fastening installation conditions to be implemented.
Rail widths H (mm)	40 60 80 100 120
Article number	3323002 3323102 3323202 3323302 3323402

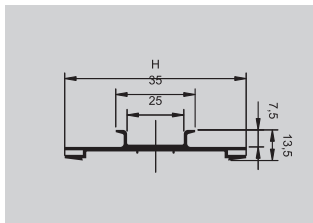

Type	Mounting rail CSL
Use	Mounting rail with low hat rail, 7.5 mm, to DIN/EN 60715 for the installation of components for hat rails.
Rail widths H (mm)	40 60 80 100 120 160
Article number	3323512 3323612 3323712 3323812 3323912 3323412

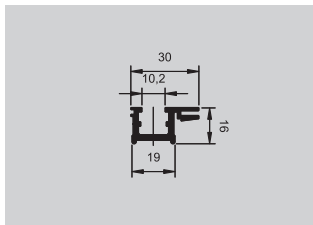
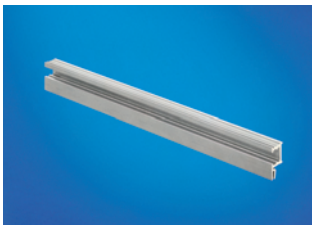

Type	Mounting rail CAF
Use	Mounting rail with recessed groove. The groove is only available on the longitudinal side to accept the comb profile. The CAF rail is often used as an end rail at the top and/or at the bottom with a frame.
Rail widths H (mm)	30
Article number	3324002

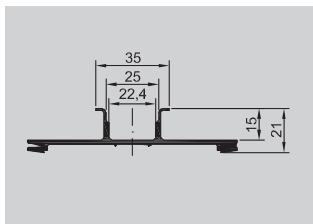

Type	Mounting rail CSLH
Use	Mounting rail with high hat rail, 15 mm height. According to DIN/EN 60715 for the installation of components for hat rails
Rail widths H (mm)	100
Article number	3324812

Profile article number	LSC type A/B/C/D	Stock length or individual length in mm	Our stock lengths for LSC-BRACKET	521 721 921 1121	488 688 888 1088
-------------------------------	-------------------------	--	--	------------------------	------------------------

346101 **B** **0721**

The order number of the rails contains the profile article number, LSC type and length (stock length or individual length)

² For ordering information, see the end of the catalogue.

3. Mounting

3.7 Support rails

In both the vertical and horizontal directions, support rails are used as frame struts to attach the brackets or other rail supports. The grooves in the support rails can also be used for direct component mounting.

Preferable for use with the **LSC-ALPHA**, **LSC-BRACKET** and **LSC-DISTANCE** systems

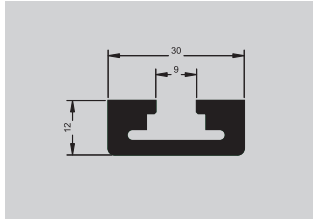
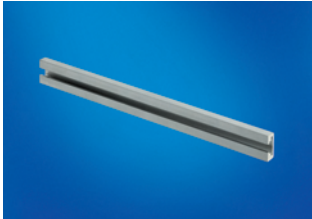

Type	CP support rail (C rail)
Art. no	330108 ²
Use	Suitable for small mounting frames. With groove for M8 hexagonal nuts or bolts. Also for direct mounting of medium-sized components such as converters, servo-controllers, etc.

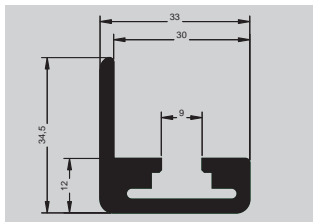
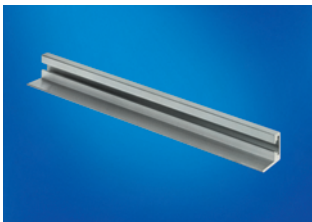

Type	WP support rail (angle rail)
Art. no	330118 ²
Use	Suitable for medium-sized and large frames. Primarily used with frame type A, as the angle can serve as a stop. With groove for M8 hexagonal nuts or bolts.

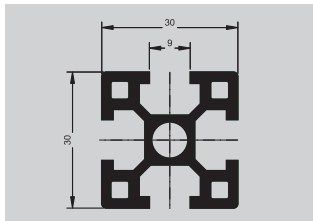

Type	VPsym support rail (Square rail with four grooves)
Art. no	330138 ²
Use	Suitable for nearly all large and heavy frames and superstructures. The symmetrical arrangement of the grooves permits installation of all kinds of applications.

Usable with the **LSC-COMPACT** system

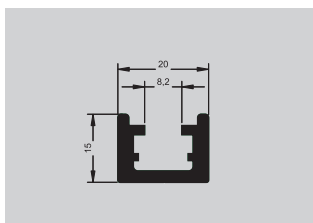
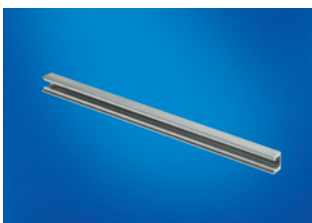

Type	CTE support rail (Square rail with groove for groove nut)
Art. no	332150 ²
Use	This type of support rail is primarily used for the lighter frames of the C series. The groove is used to accept the M6 nuts to fasten the side supports and rails.

Usable with all LSC systems

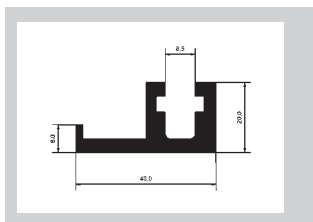
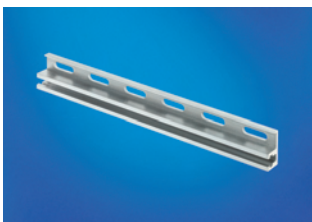

Type	Adapter rail RG	
Use	The adapter rails are used for additional component mounting without hat rail fastening. When combined with hat rail adapters, any position from horizontal to vertical is possible. With premarked slots for easy mounting.	
Article number	330100.2000	PU (2 m)
Stock length (mm)	2,000	1
Rail	RG	1

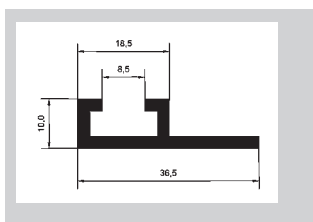
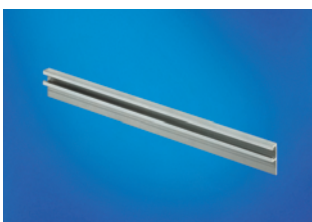

Type	Adapter rail C-RG	
Use	The adapter rails are used for additional component mounting without hat rail fastening. When combined with hat rail adapters, any position from horizontal to vertical is possible. Fastening points must be drilled.	
Art. no.	331878.2000	PU (2 m)
Stock length (mm)	2,000	1
Rail	C-RG	1

² For ordering information, see the end of the catalogue.

3. Mounting

3.8 Brackets

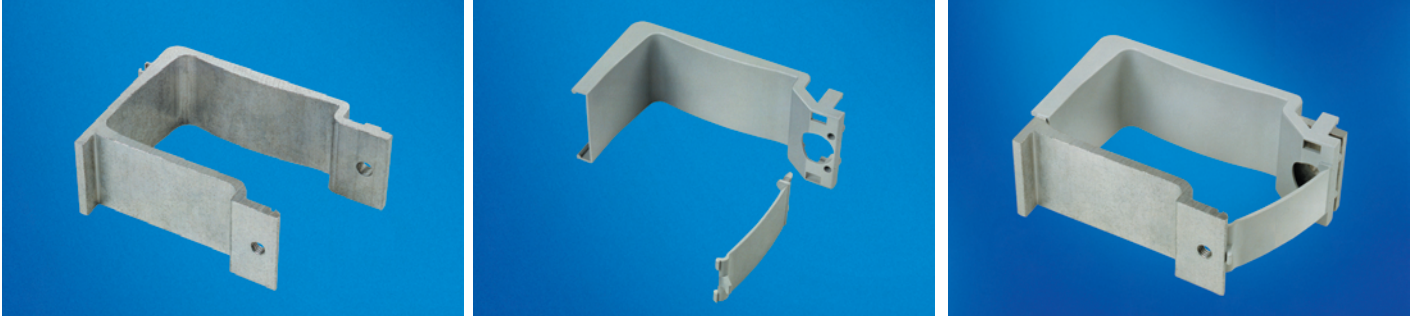

The significance of the brackets

The brackets connect the vertical support rails with the horizontal mounting rails. The special design and the repeated structure along the support rail creates a cable route similar to a cable duct, which can be accessed from the side. The supplied plastic insert protects the cables against damage.



Bracket set

Type	Art. no.	PU
MB 26/50	345216	10
MB 46/50	345217	10
MB 26/80	345218	10
MB 46/80	345219	10
MB 18/80	345215	10
MB 18/120	345214	10

Possible single parts are replacement

Bracket cover		Bracket lock	
Art. no.	PU	Art. no.	PU
345170.0010	10	345180.0010	10
345171.0010	10	345180.0010	10
345172.0010	10	345182.0010	10
345173.0010	10	345182.0010	10
345174.0010	10		
345175.0010	10		

3.9 Side supports

The significance of the side supports

The smaller, lighter design of the LÜTZE wiring system is called **LSC-COMPACT**. Here too, the philosophy of economical use of space in a control housing applies. Space is won for the wiring plane using side supports, which are permanently screwed to the mounting rails, the rails for the control components and the support rails.

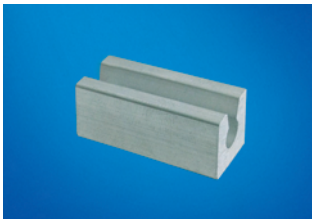

Type	Art. no.	Dimensions (mm)	PU
CST 10	346345	15x15x10	100
CST 23	332901	15x15x23	100
CST 35	332925	15x15x35	100
CST 48	332948	15x15x48	100

For installation information, please refer to Chapter 7

4. Wiring accessories

4.1 Wiring combs and covers

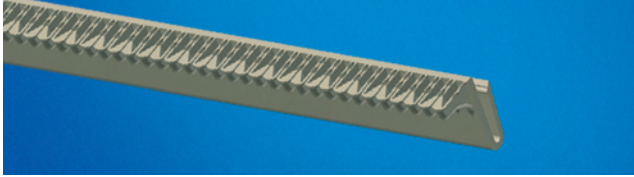

Type	Art. no.	PU
KP 300	330004	150
KP 300 blue	333008	150

For secure fixing of individual wires from 0.5 mm² to 4 mm².
Length of the comb profiles: 300 mm.

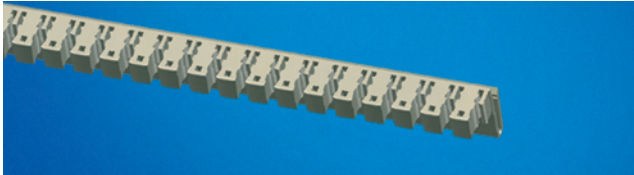

Type	Art. no.	PU
KP 301	330023	150

For secure fixing of individual wires or cables of up to 10 mm².
Length of the comb profiles: 300 mm.

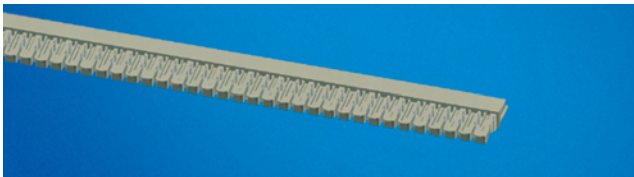

Type	Art. no.	PU
CKP 300	332000	150
CKP300 blue	332921	150

For secure fixing of individual wires from 0.5 mm² to 4 mm².
Length of the comb profiles: 300 mm.

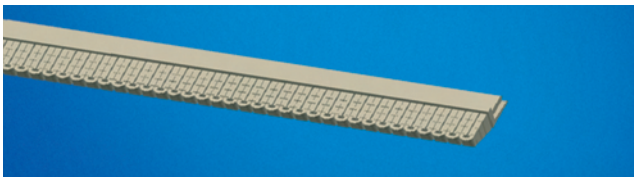

Type	Art. no.	PU
CKP 301-4	332001	150

For secure fixing of up to four individual wires per seat from 0.25 mm² to 2.5 mm².
Length of the comb profiles: 300 mm.

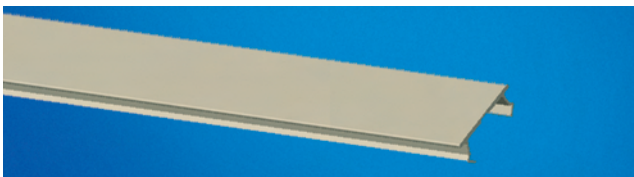

Comb covers, primarily used with the wiring combs mentioned above:

Type	Art. no.	PU (m)	Type	Art. no.	PU (m)
KDH 40	330030	10	KDH 61	330034	10
KDH 50	330031	10	KDH 50 blue	333009	10
KDH 51	330032	10	KDH 60 blue	346198	10
KDH 60	330033	10	Comb cover stock length: 2,000 mm.		

Comb covers to close the cavities between the comb profiles.

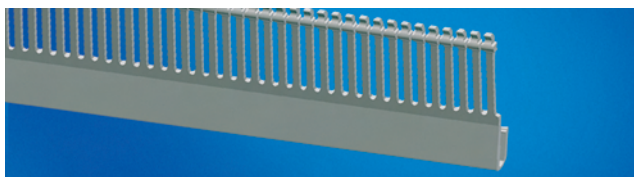

Type	Art. no.	PU (m)
LV 78	330002	10

The LV 78 profile allows the creation of standard cable ducts.
Comb cover stock length: 2,000 mm.

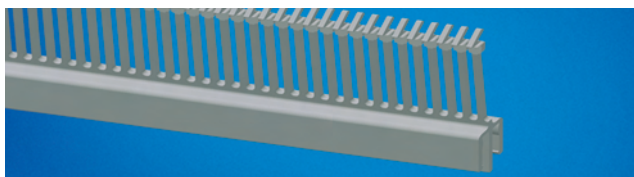

Type	Art. no.	PU (m)
LV 78 U	300102	10
LV 50 U	300105	10

Only use LV 78 U/LV 50 U in conjunction with the cover type DH...
Comb cover stock length: 2,000 mm.

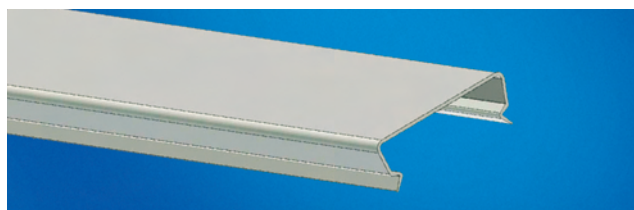

Comb covers, primarily used with the wiring combs mentioned above:

Type	Art. no.	PU (m)	Type	Art. no.	Properties	PU (m)
D 25	300061	10	DH 25	300161	halogen-free	10
D 40	300062	10	DH 40	300162	halogen-free	10
D 60	300063	10	DH 60	300163	halogen-free	10
D 80	300064	10	DH 80	300164	halogen-free	10
D 100	300065	10	DH 100	300165	halogen-free	10
D 120	300066	10	DH 120	300166	halogen-free	10

Comb cover stock length: 2,000 mm.

5. Accessories

5.1 Mounting aids

Bolts, nuts, tooth lock washers

The following applies to all nuts and bolts: other threads and lengths on request!

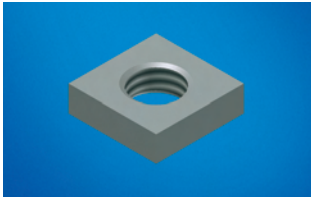

Type	Art. no.	Art. no. from 2009	PU
GL M3	346340	330940.0100	100
GL M4	346341	330941.0100	100
GL M5	346342	330942.0100	100
GL M6	346338	330943.0100	100
GL M8	346339	330944.0100	100

Slide nuts for use in all profiles with an appropriate groove. Every glide nut fits in every groove.



Type	Art. no.	Art. no from 2009	PU
GMK	331023	331023.0100	100

The glide nut retainer keeps the glide nut in the appropriate position, even when used vertically.

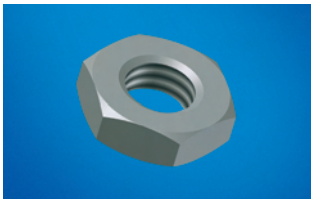

Type	Art. no.	Art. no. from 2009	PU
SKM M8	346343	330902.0100	100
SKM M8 flat	345623	330965.0100	100

Standard hexagonal nuts for general fastening. The "flat" type can be used anywhere where the 5.3 mm nut cannot be used.

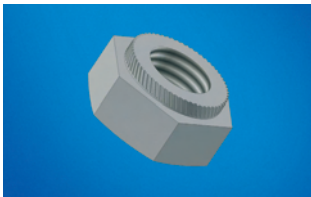

Type	Art. no.	Art. no from 2009	PU
Set nut SM 4	330911	330911.0100	100
Set nut SM 5	330912	330912.0100	100
Set nut SM 6	330913	330913.0100	100
Set nut SM 8	330914	330914.0100	100
Set nut SM10	330915	330915.0100	100

Set nuts for fitting in mounting rails, for screw fastening of components.



Type	Art. no.	Art. no from 2009	PU
FZ M8	330903	330903.0100	100
CFZ M6	332914	332914.0100	100

Toothed lock washers for screw fastenings.



Type	Art. no.	Art. no. from 2009	PU
CSS M6x25	345624	332911.0100	100
CSS M6x35	345615	332912.0100	100
CSS M6x45	332923	332923.0100	100
CSS M6x60	332947	332947.0100	100

Bolts of greater length to fasten side supports/spacers.



Type	Art. no.	Art. no from 2009	PU
AS M8x16	345613	330901.0100	100

Hexagonal bolts preferred for bracket fastening. Other bolt lengths on request.



Type	Art. no.	Art. no. from 2009	PU
FK M8x10	345618	345628.0100	100
FK M8x60	345626	345629.0100	100

Flat-head bolt preferred for rail fastening.

5. Accessories



Type	Art. no.	Art. no. from 2009	PU
HKS M5x25	330153	330153.0100	100
HKS M6x25	346356	330154.0100	100
HKS M8x25	346344	330900.0100	100

For reinstallation of bolts in equipped grooves.



Type	Art. no.	Art. no. from 2009	PU
Stud bolt M4x35	345622	330971.0100	100
Stud bolt M5x35	345619	330972.0100	100
Stud bolt M6x35	345620	330973.0100	100
Stud bolt M8x35	345621	330974.0100	100

Stud bolt with Allen head. For use as a stud bolt for fastening devices.

5.2 Mounting aids Brackets, straps, fastenings

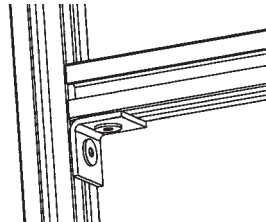

Type	Art. no.	Dimension mm	Fastening hole mm	PU
MWL Mounting bracket.	330548	30x30x3	8.5	10

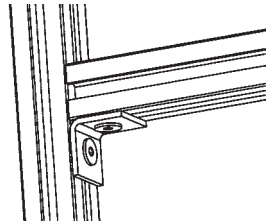

Type	Art. no.	Dimension mm	Fastening hole mm	PU
MW	330010	40x40x4	8.5x16	10
MW Mounting bracket.	330850	30x30x3	8.5x16	10

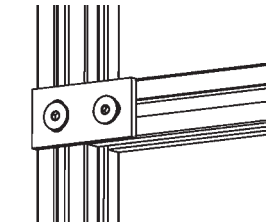
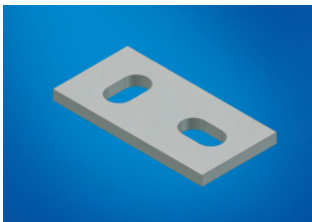

Type	Art. no.	Dimension mm	Fastening hole mm	PU
VL Flat iron connector, connecting shackle.	330011	30x60x4	8.5x16	10

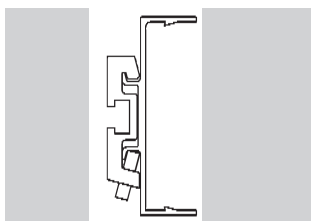
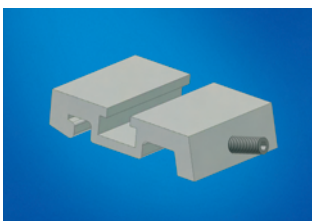

Type	Art. no.	PU
HSA adapter Hat rail adapter with groove for glide nuts of M3 to M8.	330019	1

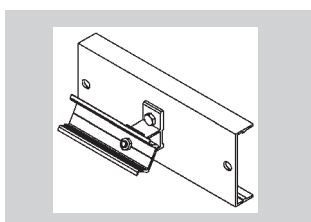

Type	Art. no.	PU
Inclined holder KSS Module with groove for glide nuts at an angle of 30° to the vertical.	330926	10

5. Accessories

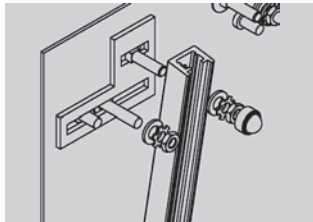

Type	Art. no.	PU
GES Rittal CM	346700	1

Fastening bracket for the installation of C frames in CM housings. Set consists of two brackets plus fastening material.

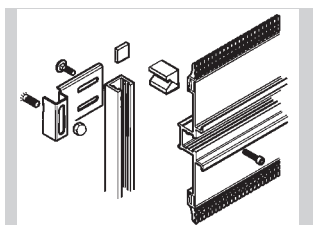
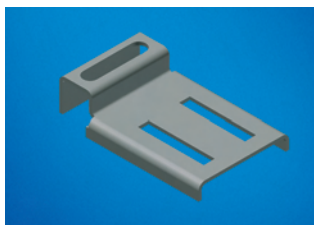

Type	Art. no.	PU
CGE4	332916	1

Fastening shackle for the installation of C frames in AE housing. Set consists of four flanges plus fastening material.

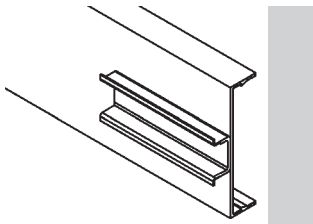
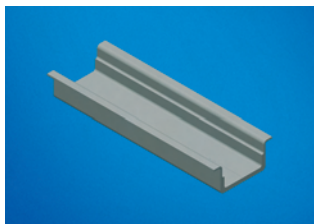

Type	Art. no.	PU
HS35/15	346355	1
HS35/7.5	330997	1

Stock length (mm) 2,000
Hat rails, aluminium.

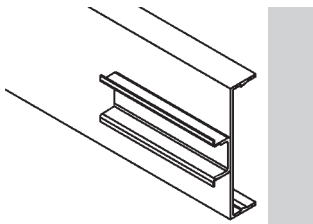
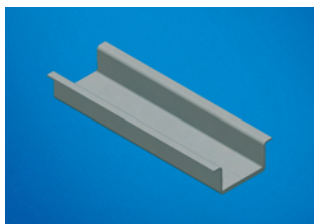

Type	Art. no.	PU
HS35/15	346458	1
HS35/7.5	345114	1

Stock length (mm) 2,000
Hat rails, steel.

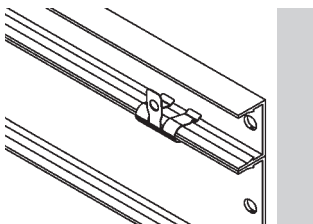
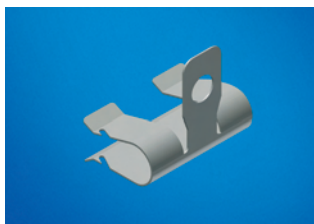

Type	Art. no.	PU
VK	330957	10

Brackets to connect individual rails.

5. Accessories

5.3 General mounting aids

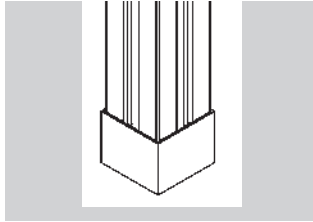
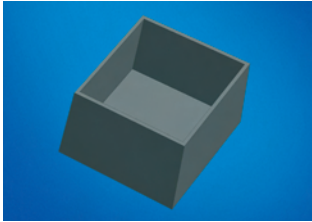

Type	Art. no.	PU
VK 30	330958	10

30x30 cover cap for VPsym support rail.

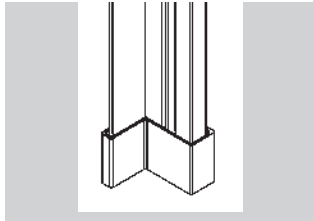
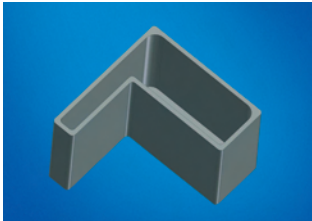

Type	Art. no.	PU
WP right	330151	10
WP left	330152	10

Cover cap for WP support rail.

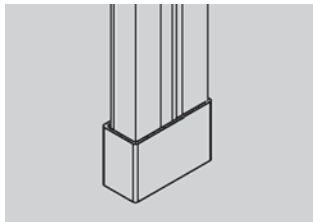
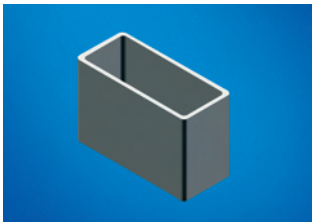

Type	Art. no.	PU
CP	330987	10

Cover cap for CP support rail.

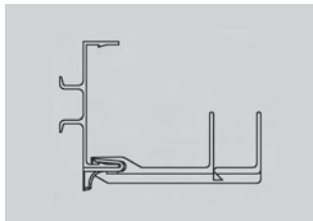

Type	Art. no.	PU
DRHA 02	330688	10

Wire retainer for preventing the sagging of terminated wires.

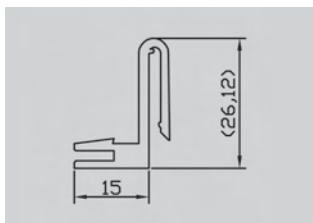
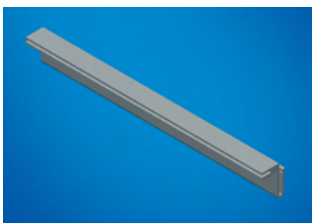

Type	Art. no.	PU (m)
SV ABD 12.5	330881.2000	10

Stock length (mm) 2.000

Rail widener. Plastic profile to widen a rail. Single-sided attachment for asymmetrical widening, two-sided attachment for symmetrical widening. (Not compatible with LSC-COMPACT!)

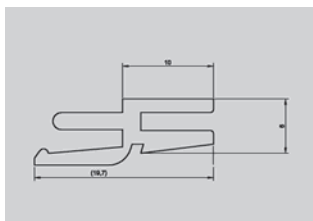

Type	Art. no.	PU (m)
SV C 10	332960.2000	10
SV C 15	332961.2000	10

Stock length (mm) 2.000

Rail widener. Plastic profile to widen a rail. Single-sided attachment for asymmetrical widening, two-sided attachment for symmetrical widening.

6. EMC accessories

6.1 The new EMC shield rails

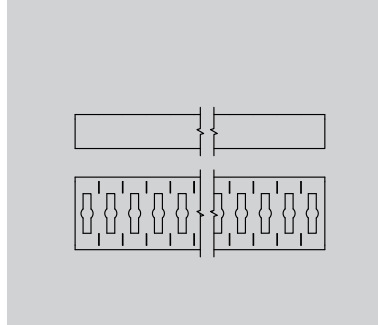
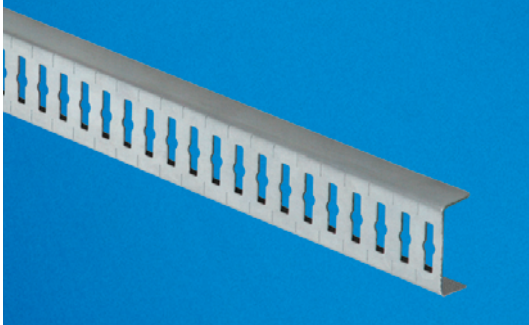

Type	Art. no.	Length mm	PU
EMVS 04-55813	346813	1155	1

EMC rail with cable support option.

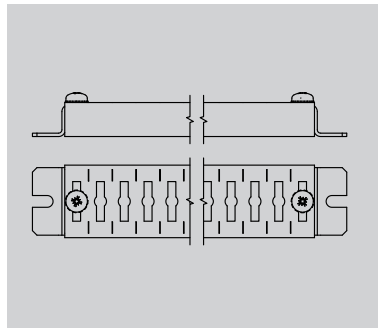
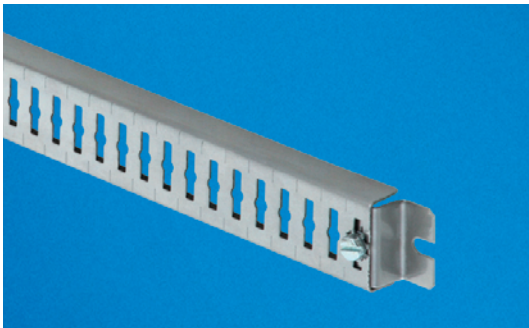

Type	Art. no.	Length mm	PU
EMVS 04-11831	346831	231.0	5
EMVS 04-27832	346832	567.0	2
EMVS 04-5855	346855	115.5	1

These EMC rails are supplied with a retaining bracket.



Type	Art. no.	PU
EMVS 346814.0010	03-46812	10

Retaining bracket to fasten the EMC rails

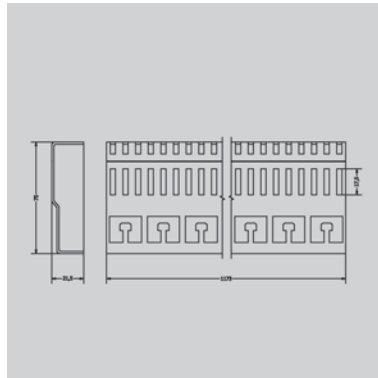
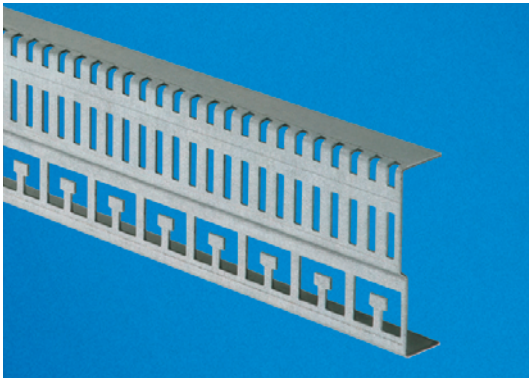

Type	Art. no.	Length mm	PU
EMVS 03-46812	346812	1173	1

EMC rail with cable support option. For all kinds of shield brackets.

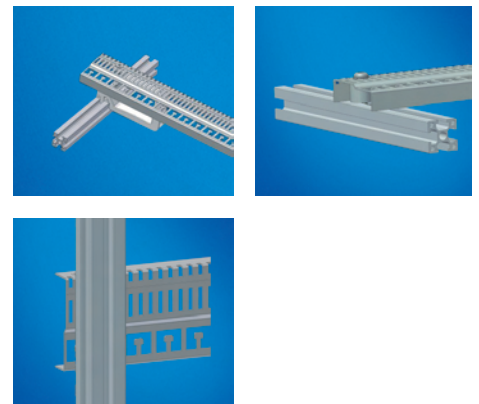
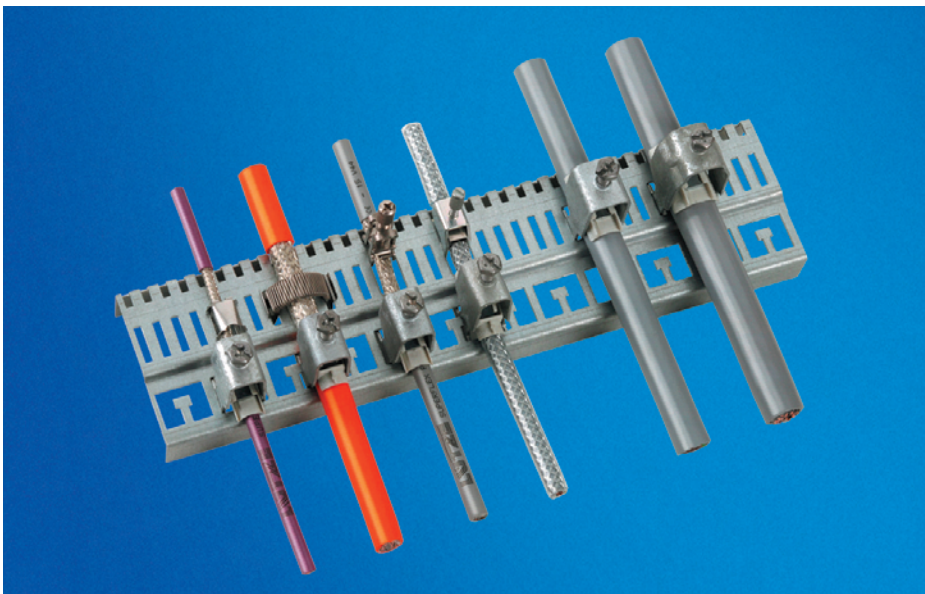

The new generation of EMC rails:
For all kinds of shield brackets.

6. EMC accessories

6.2 EMC shield rails and accessories

Phase-out products!

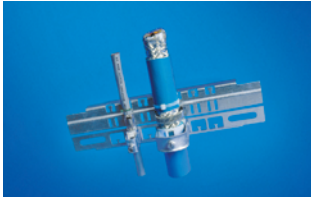

Type	Art. no.	Shield contacts	Shaft width mm	Length for the shield rails in mm
EMVS 01-18055	330055	18	600	578
EMVS 01-26056	330056	26	800	778
EMVS 01-34057	330057	34	1000	978
EMVS 01-42058	330058	42	1200	1178
EMVS 01-07054	330054	7	Special length*	300

* Special lengths/quantities on request



Type	Art. no.	Shield contacts	Length mm
EMVS 02-04069	330069	4	98

* Special lengths/quantities on request



Type	Art. no.	Shield contacts	Length mm
EMVS 07-08053	330053	8	205



Type	Art. no.	Shield contacts	X = Length mm
EMVS 07-48061	330061	48	1062
EMVS 07-04064	330053	4	110*
EMVS 07-16065	330065	16	354*

* Special lengths/quantities on request

6. EMC accessories

6.2 EMC shield rails and accessories

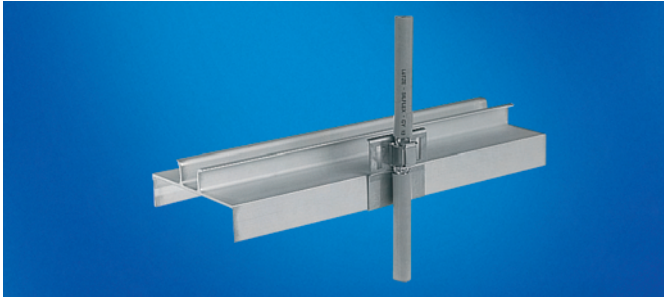

For shield contacting, the locking element can be locked onto the mounting rails in any position.

EMC locking element EMVRE 1/2

The locking element EMVRE 1 (1) is designed to lock onto the mounting rails like the comb profiles. The locking element

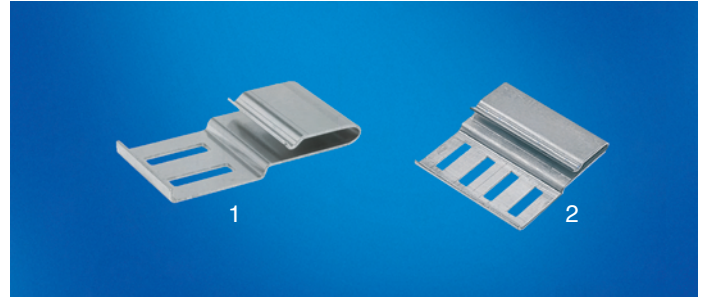

can accept a small shield clamp. Series attachment in conjunction with the locking element EMVRE 2 (2) allows the creation of any number of bracket seats.

Accessories	Type	Art. no.	Length mm	Material	PU
Locking element	EMVRE 1	330074	24	Spring steel	10
Locking element	EMVRE 2	330068	43.5	Spring steel	10



Ribbon earthing, tin-plated copper mesh, in various lengths and cross-sections with pressed on contact sleeves. Ribbon earthers counteract the current displacement effect at high frequencies, thus offering extremely high connection options.

Type	Art. no.	Cross-section mm ²	Length mm	PU
EMVFB 10/100/M6	330173	10	100	10
EMVFB 10/200/M6	330075	10	200	10
EMVFB 10/300/M6	330078	10	300	10
EMVFB 16/200/M8	330076	16	200	10
EMVFB 16/300/M8	330079	16	300	10
EMVFB 16/400/M8	330038	16	400	10
EMVFB 16/500/M8	330039	16	500	10
EMVFB 16/600/M8	330040	16	600	10
EMVFB 25/200/M8	330077	25	200	10
EMVFB 25/300/M8	330080	25	300	10

Matching earthing kit

Type	Art. no.	PU
ES8	331805	1
ES6	331816	1

6. EMC accessories

6.2 EMC shield rails and accessories

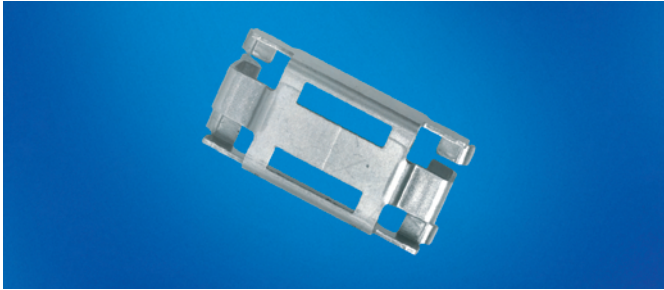

EMC shield contacting on the hat rail TS 35.

The EMVRE H1 shielding contact was developed for large shielding contact areas on the hat rail. It can easily be snapped onto the hat rail. The cable jacketing is removed to

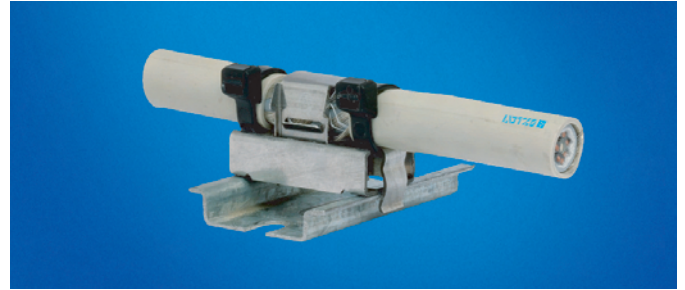

the width of the base area and clipped on to provide a large area contact with the shield clamp. The shielding contact also offers the option of strain relief at both ends using the cable's insulation jacket with the tie wraps.

Type	Art. no.	Material	Length mm	Weight kg/100 pieces	PU
EMVRE H 1	330088	Spring steel	18	0.7	10

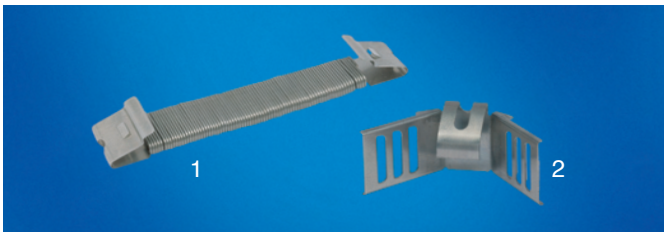

Spring shield clamps (1), shield clamps (2).



Metal tie wraps (3), cable clamps (4).

Accessories	Type	Art. no.	For cable Ø mm	Material	Weight kg/100 pieces	PU
Shield clamp (Fig. 2)	EMVSK 12	330089	0 - 12	Spring steel	0.25	100
Spring clamp (Fig. 1)	EMVFSK 1	330071	12 - 20	Spring steel	0.3	10
Spring clamp (Fig. 1)	EMVFSK 2	330072	20 - 30	Spring steel	0.5	10
Spring clamp (Fig. 1)	EMVFSK 3	330073	30 - 50	Spring steel	0.7	10
Metal tie wrap (Fig. 3)	(KSE)	330060	210 mm length	Stainless steel	3.0	10
Cable clamp as support option (Fig. 4)						
Cable clamp*	KS 0	331000	8 - 12	Galvanised	3.0	10
Cable clamp*	KS 1	331001	12 - 16	Galvanised	3.2	10
Cable clamp*	KS 2	331002	16 - 22	Galvanised	3.5	10
Cable clamp*	KS 3	331003	34 - 40	Galvanised	6.8	10
Cable clamp*	KS 4	331004	52 - 58	Galvanised	11.5	10

*incl. pressure and counter insert

7. Technical information

7.1 Wiring information



Fig. 1

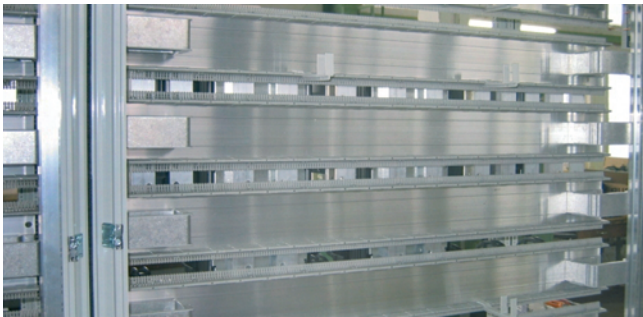

Fig. 2

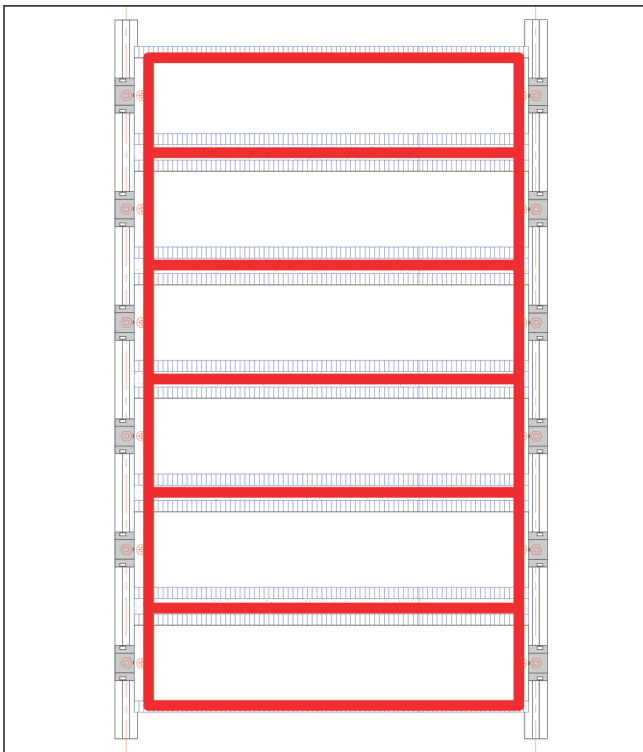

Fig. 3

Wiring with LÜTZE LSC-BRACKET systems (mounting bracket wiring system)

Wiring takes place in the same way as cable duct wiring, only from the front. The insert is intended for floor and series cabinets. The cabinets can be located directly next to the wall.

In contrast to duct wiring, the cables are fixed in wiring combs (Fig. 1), run via brackets on the rear side of the mounting frame and connected on the front side (Fig. 1).

The wires should be inserted loosely, should not be taut, which would otherwise make tracing difficult.

The wiring paths are defined exactly (no X wiring as with the LSC-A system, Fig. 3 and Fig. 4):

- The vertical wiring is run down the side at the rear in the area of the bracket. Depending on the wiring frame, brackets of various heights are available (50/80/120 mm).
- Horizontal wiring takes place between the rails in comb or wiring profiles. The rail spacings should be selected according to the space requirements or the cables to be laid.

Wire retainers (optional, article no.: 330688) can be locked into the wiring comb at any position on the rear side. They are used to run wires for control cabinet widths of greater than 600 mm.

Please note: with the LÜTZE LSC wiring system, there is no need for rear access!*

Wiring front the front

The wiring paths, indicated in red, are located on the rear side. However, wiring takes place from the front side. The fastening of the rails to the support rails using clamps produce side cavities, which always allow access from the front.

* Exception: LSC-A system with X wiring

7. Technical information

7.2 LSC in the vibration and shock test



LSC in the control cabinet: the first vibration and shock-tested wiring system

The Lütze LSC wiring system, with its screwed-on rails, can pass any vibration and shock test without problems. This means that, when the Lütze LSC system is used in the control cabinet, the requirements of the standard EN 61373 (mechanical testing and safety aspects for cabinets) are fulfilled.



7.3 Proof of conductivity

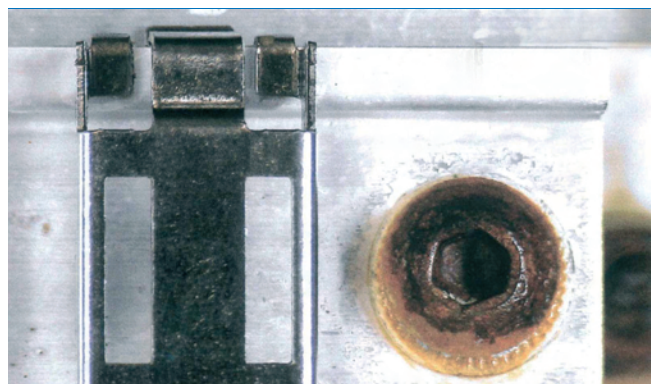

An end to prejudices about aluminium

A scientific investigation, commissioned by Lütze, has shown that, even with extreme surface oxidation of aluminium profiles, the contact resistances only increase slightly.

The test series

LSC or individual aluminium profiles are subjected to all kinds of climactic conditions using the Kesternich test according to DIN 50018: 1997 KWF 1.0 S. Although the aluminium test items and the contact and serrated discs used were covered with rust and considerable traces of corrosion, no major changes of the contact resistances

were measured during and after the test in the area of the screw and connection points. Even under tropic maritime climactic conditions with 5% salt spray at 35°C over 96 hours, the result was similar: the aluminium test items and connections were covered with white rust, but no major changes to the resistances were measured.

Result: the electrical properties of the aluminium remain almost intact. The standard of the Kesternich test permits a change in resistance of 150%.

The electrical resistance in the test series changed only by a maximum 10%.

7. Technical information

7.4 Specification of the mounting rail length with the example of the LSC-BRACKET

The following frame widths have shown themselves to be ideal for standard control cabinet widths of 600 - 1200 mm. Of course, all the other frame widths are possible, in particular for special cabinets and for the other frames LSC-ALPHA, LSC-COMPACT and LSC-DISTANCE.

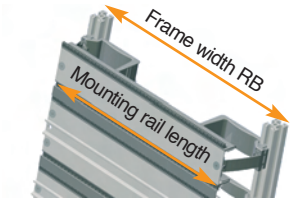

Sample dimensions for the standardisation of the cabinet width		
Cabinet width mm	Mounting rail length SL mm	Frame width VPSym mm
600	521	571
800	721	771
1000	921	971
1200	1121	1171

The frame height is 1880 mm for 2000 mm cabinets. Available ready for installation for all standard cabinet widths!

7.5 LSC-BRACKET: Bracket installation situation

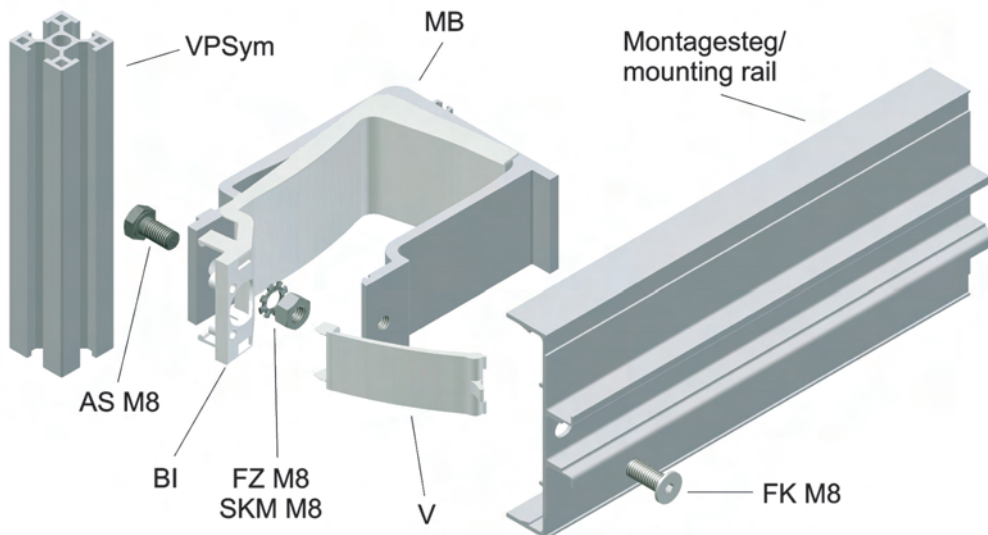

7.6 Available installation depth

With the example of a LSC-BRACKET frame, installed in a TS8 cabinet (Rittal).

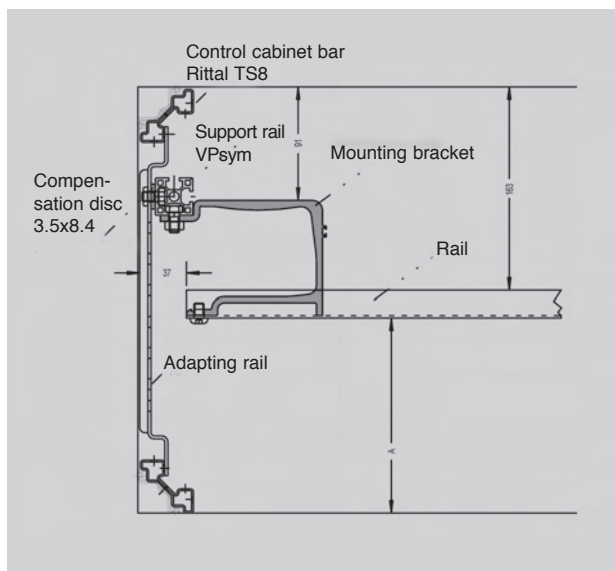

Cabinet depth mm	Component installation depth "A" mm
400	214
500	314
600	414
800	614

When the bracket 46/50 is installed, the installation depth increases by 30 mm

7. Technical information

7.7 LSC-COMPACT: Side support installation

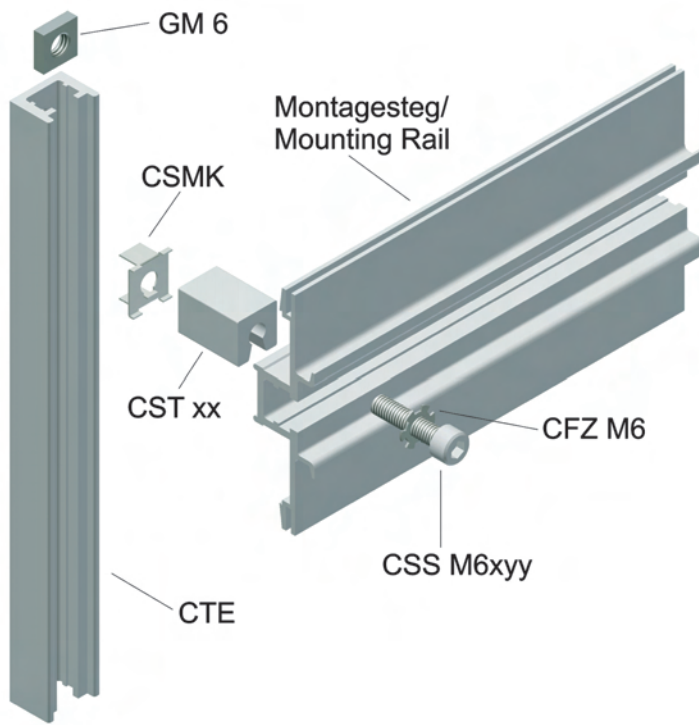

Suitable M6 bolt for side support			
Type of side support	Art. no.	Type of M6 bolt	Art. no.
CST 10	346345	CSS M6x25	332911.0100
CST 23	332901	CSS M6x35	332912.0100
CST 35	332925	CSS M6x45	332923.0100
CST 48	332948	CSS M6x60	332947.0100

7.8 Materials

Support rails, mounting rails, side supports, mounting brackets MB	
Material	Al Mg Si 0.5 F 25
Strain resistance, N/mm ²	250
Surface/colour	Natural aluminium, shiny and electrically conductive

Tie and flat-headed bolts AS, FK, CSS	
Material	Steel
Resistance class	min. 4.8
Surface/colour	Bright galvanised

Wiring comb KP 300/KP 301/CKP 300/CKP 301-4	
Material	PP (halogen-free)
Fire class according to UL	(UL 94 V0)
Operating temperature	0 - 60 °C
Colour	Grey/blue for Ex (KP 300 and CKP 300)

Comb cover KD 40/KDH 50/KDH 51/KDH 61	
Material	ABS (halogen-free)
Fire class according to UL	(UL 94 HB)
Operating temperature	0 - 60 °C
Colour	Grey/blue for Ex

Wiring profile section LV 78 and cover	
Material	PVC-h
Fire class according to UL	(UL 94 V0)
Operating temperature	0 - 60 °C
Colour	grey

Wiring profile section LV 50U	
Material	PP OS (halogen-free)
Fire class according to UL	(UL 94 V0)
Operating temperature	0 - 60 °C
Colour	RAL 7035

Adapter AP	
Material	PS/475 (halogen-free)
Fire class according to UL	(UL 94 HB)
Operating temperature	0 - 60 °C
Colour	grey

Bracket lock BV/cover caps M6/M8	
Material	PA 6/PA 66 (halogen-free)
Fire class according to UL	(UL 94 V0)
Operating temperature	0 - 60 °C
Colour	grey

Edge protector KSP	
Material	PVC
Fire class according to UL	(UL 94 HB)
Colour	Black

7. Technical information

7.9 Current capacity of the LSC profiles

For all LSC profiles:	
Material	Al Mg Si 0.5 F 25
Conductance in S	24

Type	Cross-section in mm ²	Type	Cross-section in mm ²	Type	Cross-section in mm ²	Type	Cross-section in mm ²
CP	228.30	S 40	237.87	CS 40	243.74	HSA N	384.30
WP	330.05	S 60	267.64	CS 60	283.74	HS	147.80
VPSym	342.74	S 80	307.64	CS 80	323.74		
		S 100	347.64	CS 100	363.74	KSS	425.40
M 20	139.22	S 120	394.55	CS 120	403.74		
M 40	189.30					F 30	260.10
M 60	239.30	SN 40	225.67	CSL 40	172.26		
M 80	289.30	SN 60	255.47	CSL 60	212.26	F 40	285.10
M 100	339.70	SN 80	295.47	CSL 80	252.26		
M 120	389.30	SN 100	335.47	CSL 100	292.26		
		SN 120	382.34	CSL 120	332.26		
MF 80	361.73	SN 160	462.34	CSL 160	412.26		
A 23	102.11	CM 40	196.17	CSLH 100	306.94		
A 40	144.61	CM 60	236.17				
		CM 80	276.17	CAF 30	158.60		
ET	594.49	CM 100	316.17				

7.10 Tightening torques for threaded connections

Tightening torques for threaded connections (in Nm)	
U bolt M8	12.0
Nut M8	12.0
Sliding nut M8	10.0
Sliding nut M6	5.5
Sliding nut M5	5.5
Sliding nut M4	4.0
Bolt M6	6.0 - 8.0
Nut M6	6.0 - 8.0

7.11 Weights

Support rails	kg/m	Mounting rails (data in kg/m)								
		Rail height (mm)								
		20	23	30	40	60	80	100	120	160
CP	0.616	Mounting rails								
WP	0.892	ET120								
VPSym	0.938	M	0.376		0.512	0.648	0.783	0.919	1.580	1.054
Hat rail 35/15	0.295	S			0.764	0.892	1.035	1.160	1.297	
Hat rail 35/7.5	0.295	SN			0.668	0.803	0.938	1.073	1.208	1.478
CTE	0.385	MF					1.039			
RG 2000	0.840	F			0.702	0.753				
CRG 2000	0.380	A			0.275	0.391				
		CM				0.533	0.641	0.771	0.857	
		CS				0.679	0.791	0.877	0.985	1.114
		CSL				0.465	0.573	0.681	0.789	0.897
		CSLH							0.797	
		CAF				0.431				

7. Technical data

7.12 Ordering information

Rails

The order number of the rails consists of the following three individual elements:

- ▶ I. Profile article number of the rail
- ▶ II. Information on the fastening holes:
 - When ordering without a fastening hole, enter a period
 - When ordering with a fastening hole, replace the period with the letters A-D or X (variable)
- ▶ III. Length in mm (4-digit)

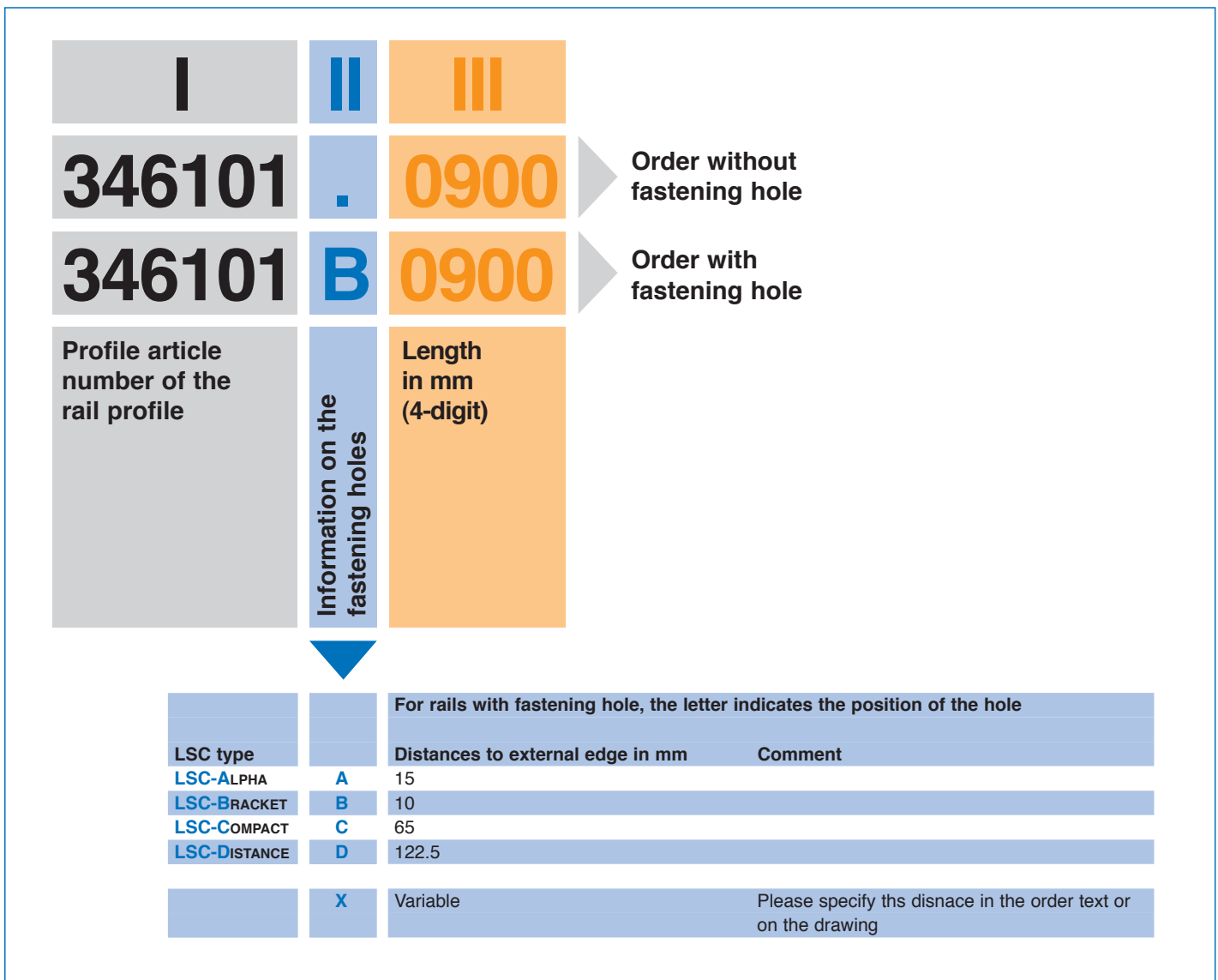

8. Application examples

8.1 Cable fixing in the comb profile KP 300

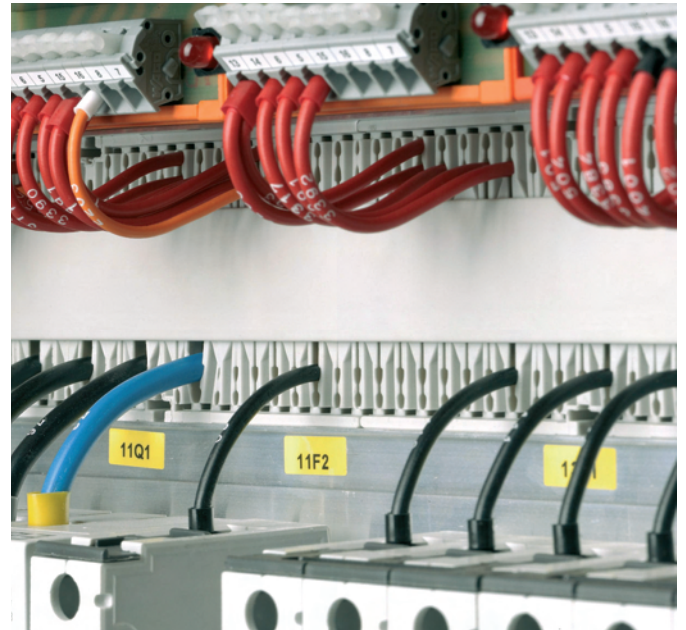
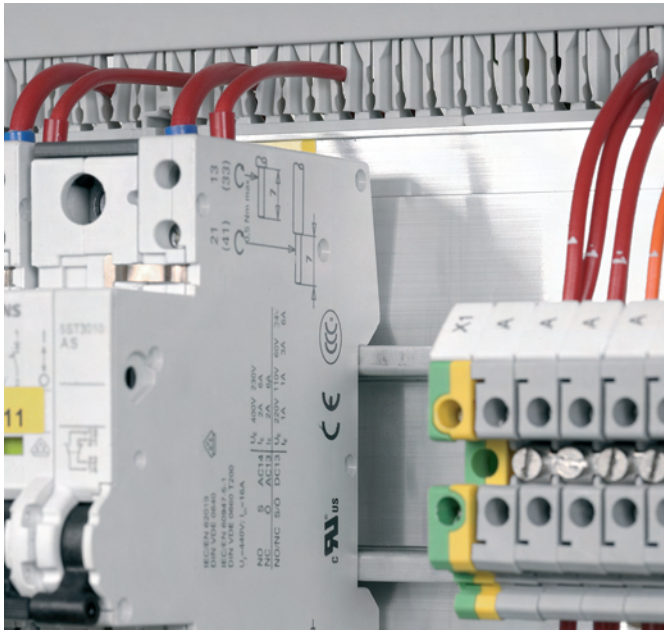

8. Application examples

8.2 Installation examples

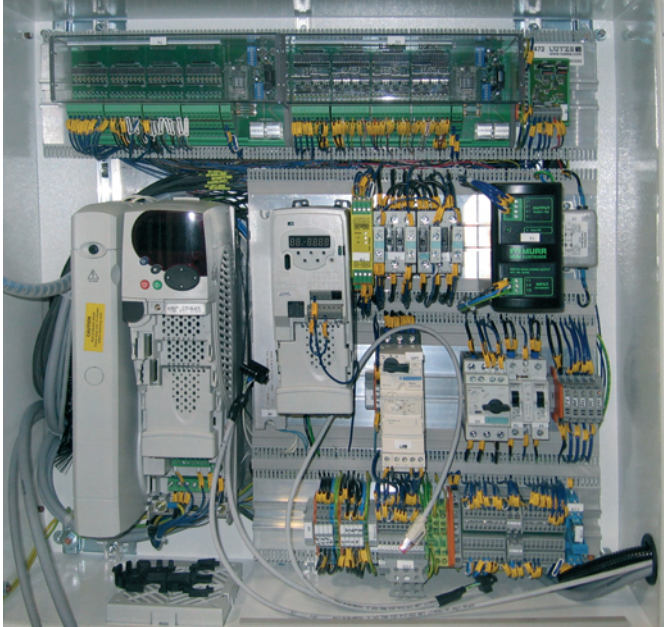

LSC-COMPACT in the application



LSC-COMPACT in the application

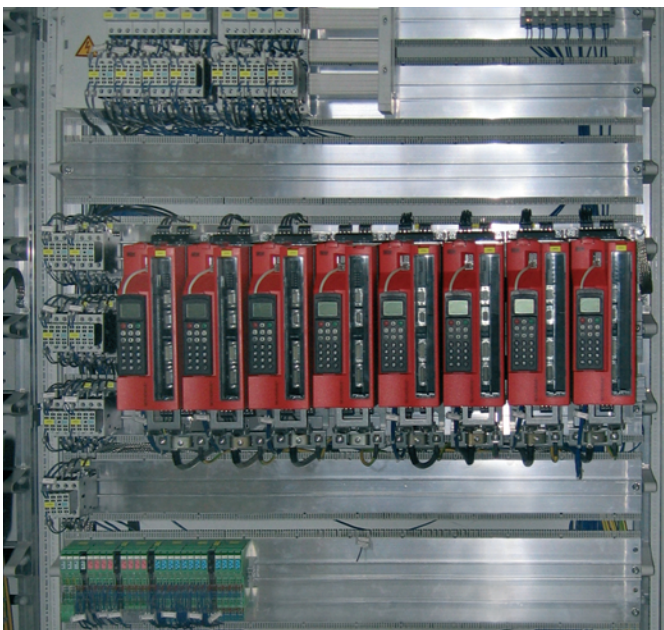

LSC-BRACKET with converter



LSC-BRACKET system in the programming cabinet

LÜTZE Automation Solutions



**Suppression systems, module and interface technology,
power supply, Ethernet infrastructure solutions**

You can find additional information on
LÜTZE Automation Solutions
in the Catalogue TK3
or at www.luetze.com



Germany

Friedrich Lütze GmbH & Co. KG
Postfach 12 24 (PLZ 71366)
Bruckwiesenstrasse 17-19
D-71384 Weinstadt
Tel.: +49 (0)71 51 60 53-0
Fax: +49 (0)71 51 60 53-277(-288)
info@luetze.de

Lütze systems for highest industrial standards:

- Prepopulated
C-track systems
- Lütze-LSC-wiring
systems for all
standard control
panels
- Powerful module and
interface technology
- Reliable suppression
technology
- Efficient power
supplies
- Automation systems
for harsh environments

United Kingdom

LÜTZE Ltd.
Unit 3 Sandy Hill Park
Sandy Way, Amington
Tamworth, Staffs, B77 4DU
Tel.: +44 (0)18 27 31333-0
Fax: +44 (0)18 27 31333-2
sales.gb@luetze.co.uk

USA

LUTZE INC.
13330 South Ridge Drive
Charlotte, NC 28273
Tel.: +1 (704) 504-0222
Fax: +1 (704) 504 -0223
info@lutze.com

Österreich

LÜTZE Elektrotechnische
Erzeugnisse Ges.m.b.H.
Tel.: +43 (0)1 257 52 52-0
Fax: +43 (0)1 257 52 52-20
office@luetze.at

Schweiz

LÜTZE AG
Tel.: +41 (0)55 450 23 23
Fax: +41 (0)55 450 23 13
info@luetze.ch

France

LÜTZE S.A.
Tél.: +33 (0)1 34 18 77 00
Fax: +33 (0)1 34 18 18 44
lutze@lutze.fr

España

LUTZE, S.L.
Tel.: +34 93 285 7480
Fax: +34 93 285 7481
info@lutze.es

China

Lutze Control System (Shanghai) Ltd.
Tel. : +86 21 51007566 0
Fax : +86 21 51007565
sales@lutze.com.cn

www.luetze.com