

- 3/4" NPT
- Brass Body
- 2-Way Zero Differential
Piloted Diaphragm
- Normally Open

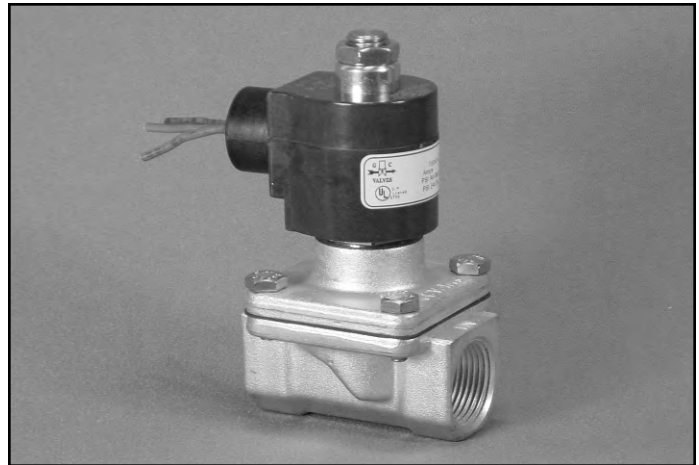

Materials	Seals:	Nitrile, Viton®, Ethylene Propylene
	Orifice: Pilot Main	Stainless Steel Brass Ø 3/4"
Electrical	Standard Housing:	Encapsulated Waterproof Conduit (NEMA 4/4X)
	Optional Housings:	Metallic Conduit, Explosion-proof (NEMA 7), Grommet, Open Frame, Junction Box (single or dual knockouts), DIN; Contact GC Valves Customer Service for others.
	Standard Voltages:	24, 120, 240 AC 60 Hz; 50 Hz available 6, 12, 24 DC; Contact GC Valves Customer Service for Additional Voltages.
	Voltage Tolerance:	±10% of applicable voltage
	Coil Classes:	F, H, N
	Standard Lead Length:	24 inch
Operating Temperature	Ambient (Nominal):	32°F to 125°F
Mounting	Position:	Any
Approvals*	Agency:	UL Listed, UL Recognized, CSA Approved

* Not available for all variations

® Registered Trademark of DuPont Co.

Dimensions/Weight

Weight (lbs.)
2.2

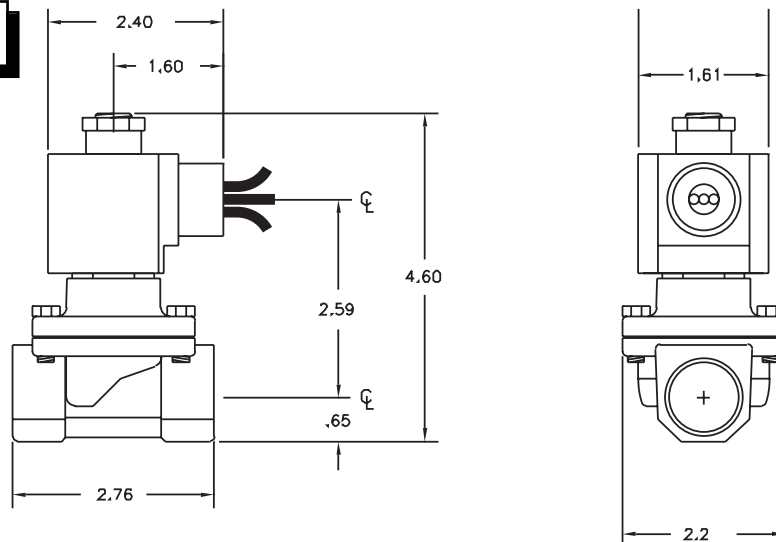

GC Valves Customer Service: 800-828-0484 (7:30am to 4pm ET) or 800-582-4232 (7:30am to 4pm PT)



S202 – 3/4" NPT, Brass Body, Normally Open

Valve Selection List

Normally Open

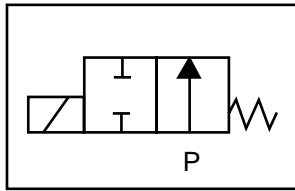

Energized

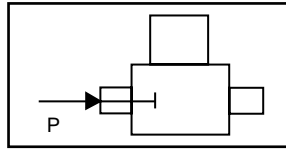

De-Energized

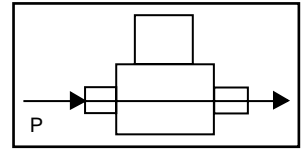

Pipe Size NPT	Orifice Size IN	C _v	Minimum	Operating Pressure Differential (psi)								Max Fluid Temp. °F	Seal Material	Power Consumption (Watts)		Model Code (120V/60HZ — 110V/50HZ) Shown
				Maximum										AC	DC	
				AC	DC	AC	DC	AC	DC	AC	DC			AC		
3/4	3/4	6.7	0	200	125	200	125	—	—	—	295	EPR	11	10	S202GF02C5EG5	
	3/4	6.7	0	200	125	200	125	200	125	—	180	Nitrile	11	10	S202GF02N5EG5	
	3/4	6.7	0	200	125	200	125	200	125	—	230	Viton	11	10	S202GF02V5EG5	
	3/4	6.7	0	—	—	—	—	—	—	50*	295	EPR	11	—	S202GH02C5EG5	

* Class H Coil Recommended for Steam and Other High Temperature Applications

Part Numbering

1	2	3	4	5	6	7	8	9	10	11	12	13
S	2	0	2	G	F	0	2	C	5	E	G	5
Series			Operating Mode	Housing*	Coil Class*	Voltage*		Seal Material	Body Material	Pipe Connection	Orifice Size	
S20			2: Normally Open	G: Conduit	F: Class F H: Class H	02: 120/60 110/50		C: EPR N: Nitrile V: Viton	5: Brass	E: 3/4" NPT	G5: 3/4"	
* See the "Engineering Guide" for additional voltages, variations and options.												

Coil Data

Coil Family	
Type	Size
All	S4

Frequency (Hz)	60	50
Nominal Power (VA)	Inrush	46
	Holding	22

GC Valves Customer Service: 800-828-0484 (7:30am to 4pm ET) or 800-582-4232 (7:30am to 4pm PT)

- 3/4" NPT
- Brass Body
- 2-Way Piloted
Diaphragm
- Normally Open

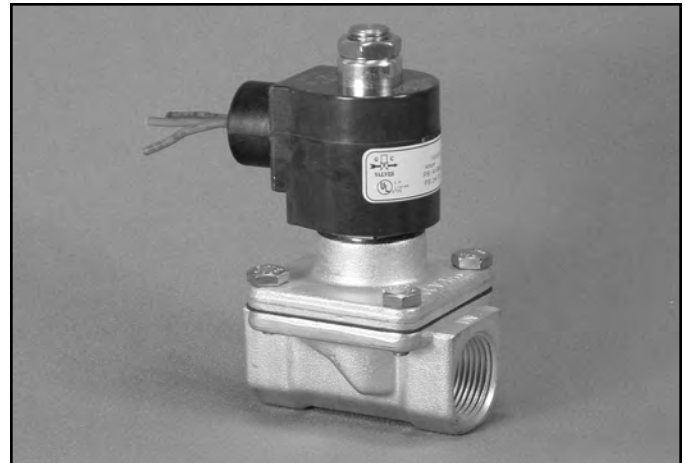

Materials	Seals:	Nitrile, Viton®, Ethylene Propylene
	Orifice:	Pilot: Stainless Steel Main: Brass Ø 3/4"
Electrical	Standard Housing:	Encapsulated Waterproof Conduit (NEMA 4/4X)
	Optional Housings:	Metallic Conduit, Explosion-proof (NEMA 7), Grommet, Open Frame, Junction Box (single or dual knockouts), DIN; Contact GC Valves Customer Service for others.
	Standard Voltages:	24, 120, 240 AC 60 Hz; 50 Hz available 6, 12, 24 DC; Contact GC Valves Customer Service for Additional Voltages.
	Voltage Tolerance:	±10% of applicable voltage
	Coil Classes:	F, H, N
	Standard Lead Length:	24 inch
Operating Temperature	Ambient (Nominal):	32°F to 125°F
Mounting	Position:	Any
Approvals*	Agency:	UL Listed, UL Recognized, CSA Approved

* Not available for all variations

© Registered Trademark of DuPont Co.

Dimensions/Weight

Weight (lbs.)

3.3

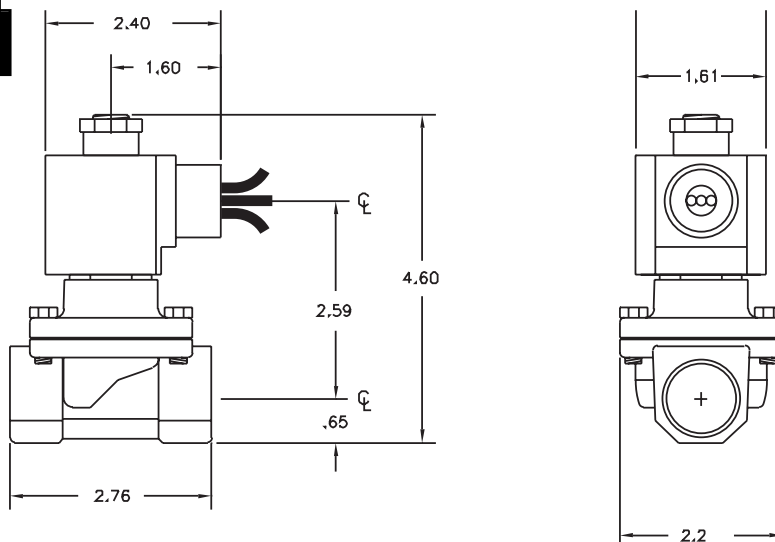

GC Valves Customer Service: 800-828-0484 (7:30am to 4pm ET) or 800-582-4232 (7:30am to 4pm PT)



S212 – 3/4" NPT, Brass Body, Normally Open

Valve Selection List

Normally Open

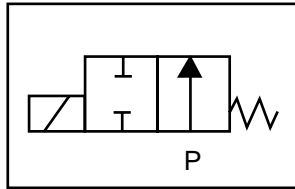

Energized

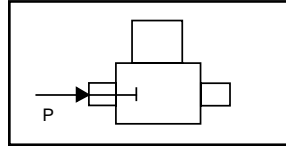

De-Energized

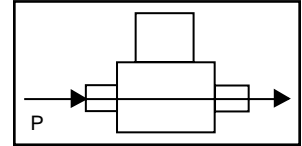

Pipe Size NPT	Orifice Size IN	C _v	Minimum	Operating Pressure Differential (psi)								Max Fluid Temp. °F	Seal Material	Power Consumption (Watts)		Model Code (120V/60HZ — 110V/50HZ Shown)
				Maximum										AC	DC	
				Air/Gas		Water		Light Oil		Steam*						
				AC	DC	AC	DC	AC	DC	AC	DC			AC	DC	
3/4	3/4	6.7	3	200	140	200	125	—	—	—	—	295	EPR	11	10	S212GF02C5EG5
	3/4	6.7	3	200	140	200	125	200	125	—	—	180	Nitrile	11	10	S212GF02N5EG5
	3/4	6.7	3	200	140	200	125	200	125	—	—	230	Viton	11	10	S212GF02V5EG5
	3/4	6.7	3	—	—	—	—	—	—	50*	50*	295	EPR	11	10	S212GH02C5EG5

* Class H Coil Recommended for Steam and Other High Temperature Applications

Part Numbering

1	2	3	4	5	6	7	8	9	10	11	12	13
S	2	1	2	G	F	0	2	C	5	E	G	5
Series			Operating Mode	Housing*	Coil Class*		Voltage*		Seal Material	Body Material	Pipe Connection	Orifice Size
S21			2: Normally Open	G: Conduit	F: Class F H: Class H		02: 120/60 110/50		C: EPR N: Nitrile V: Viton	5: Brass	E: 3/4" NPT	G5: 3/4"
* See the "Engineering Guide" for additional voltages, variations and options.												

Coil Data

Coil Family	
Type	Size
ALL	S4

Frequency (Hz)	60	50
Nominal Power (VA)	Inrush	46
	Holding	22

GC Valves Customer Service: 800-828-0484 (7:30am to 4pm ET) or 800-582-4232 (7:30am to 4pm PT)

- High Performance
- 3/4" NPT
- Brass Body
- 2-Way Piloted Diaphragm
- Normally Open

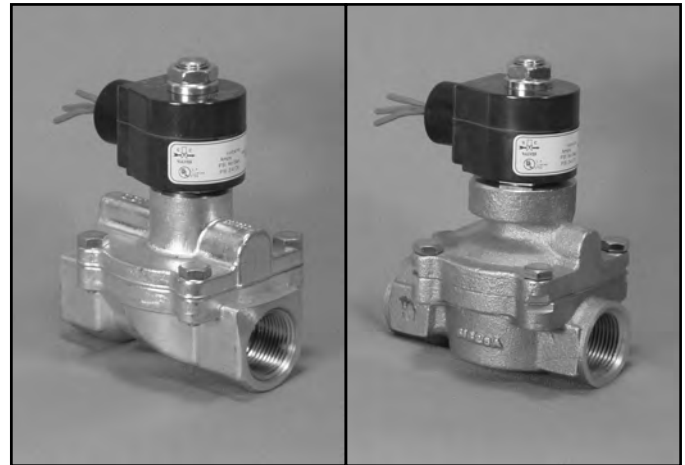

Materials	Seals:	Viton®, Teflon®
	Orifice: Pilot Main	Stainless Steel Stainless Steel Ø 3/4"
Electrical	Standard Housing:	Encapsulated Waterproof Conduit (NEMA 4/4X)
	Optional Housings:	Metallic Conduit, Explosion-proof (NEMA 7), Grommet, Open Frame, Junction Box (single or dual knockouts), DIN; Contact GC Valves Customer Service for others.
	Standard Voltages:	24, 120, 240 AC 60 Hz; 50 Hz available Contact GC Valves Customer Service for Additional Voltages.
	Voltage Tolerance:	±10% of applicable voltage
	Coil Classes:	F, H, N
	Standard Lead Length:	24 inch
Operating Temperature	Ambient (Nominal):	32°F to 125°F
Mounting	Position:	Any
Approvals*	Agency:	UL Listed, UL Recognized, CSA Approved

* Not available for all variations

© Registered Trademark of DuPont Co.

Dimensions/Weight

Weight (lbs.)
3.3

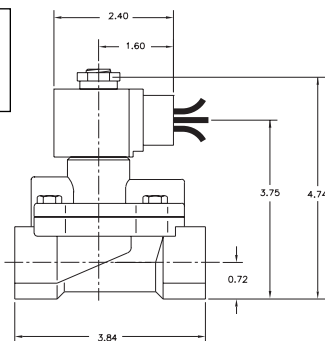

Body Code 4

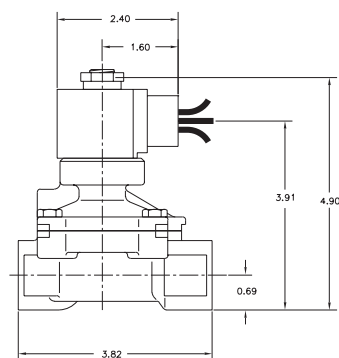
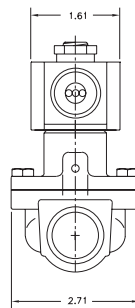

Body Code 2

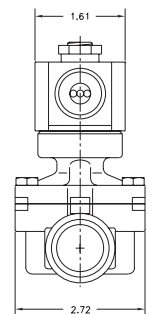

GC Valves Customer Service: 800-828-0484 (7:30am to 4pm ET) or 800-582-4232 (7:30am to 4pm PT)



S211 – High Performance, 3/4" NPT, Brass Body, Normally Open

Valve Selection List

Normally Closed

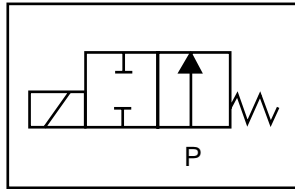

Energized

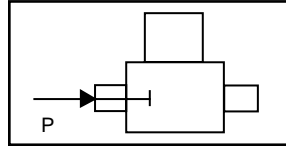

De-Energized

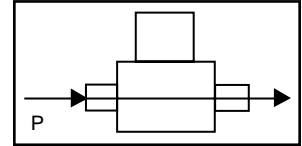

Pipe Size NPT	Orifice Size IN	C _v	Minimum	Operating Pressure Differential (psi)								Max Fluid Temp. °F	Seal Material	Power Consumption (Watts)		Model Code (120V/60HZ — 110V/50HZ Shown)
				Maximum										AC	DC	
				Air/Gas		Water		Light Oil		Steam*						
				AC	DC	AC	DC	AC	DC	AC	DC			AC	DC	
3/4	3/4	6.1	1	150	140	150	140	150	140	—	—	230	Viton	8	9	S212GF02K4EG5
	3/4	6.1	1	—	—	—	—	—	—	100*	100*	338	Teflon	8	9	S212GH02T4EG5
	3/4	7.0	10	—	—	—	—	—	—	150*	140*	366	Teflon	8	9	S212GH02T2EG5

* Class H Coil Recommended for Steam and Other High Temperature Applications

Part Numbering

1	2	3	4	5	6	7	8	9	10	11	12	13
S	2	1	2	G	F	0	2	K	4	E	G	5
Series			Operating Mode	Housing*	Coil Class*	Voltage*		Seal Material	Body Material	Pipe Connection	Orifice Size	
S21			2: Normally Open	G: Conduit	F: Class F H: Class H	02: 120/60 110/50		K: Viton T: Teflon	4: Forged Brass 2: Brass	E: 3/4" NPT	G5: 3/4"	

* See the "Engineering Guide" for additional voltages, variations and options.

Coil Data

Coil Family	
Type	Size
All	S3

Frequency (Hz)	60	50	
Nominal Power (VA)	Inrush	36	36
	Holding	18	19

GC Valves Customer Service: 800-828-0484 (7:30am to 4pm ET) or 800-582-4232 (7:30am to 4pm PT)

- 3/4" NPT
- Stainless Steel Body
Type 316
- 2-Way Zero Differential
Piloted Diaphragm
- Normally Open



Materials	Seals:	Nitrile, Viton®, Ethylene Propylene
	Orifice: Pilot Main	Stainless Steel Stainless Steel Ø 3/4"
Electrical	Standard Housing:	Encapsulated Waterproof Conduit (NEMA 4/4X)
	Optional Housings:	Metallic Conduit, Explosion-proof (NEMA 7), Grommet, Open Frame, Junction Box (single or dual knockouts), DIN; Contact GC Valves Customer Service for others.
	Standard Voltages:	24, 120, 240 AC 60 Hz; 50 Hz available 6, 12, 24 DC; Contact GC Valves Customer Service for Additional Voltages.
	Voltage Tolerance:	±10% of applicable voltage
	Coil Classes:	F, H, N
	Standard Lead Length:	24 inch
Operating Temperature	Ambient (Nominal):	32°F to 125°F
Mounting	Position:	Any
Approvals*	Agency:	UL Listed, UL Recognized, CSA Approved

* Not available for all variations

© Registered Trademark of DuPont Co.

Dimensions/Weight

Weight (LB)
2.2

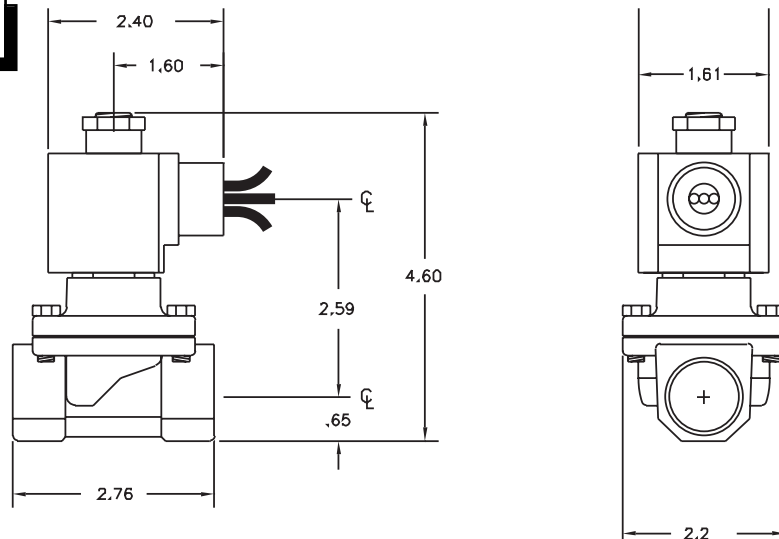

GC Valves Customer Service: 800-828-0484 (7:30am to 4pm ET) or 800-582-4232 (7:30am to 4pm PT)



S202 – 3/4" NPT, Stainless Steel Body-Type 316, Normally Open

Valve Selection List

Normally Open

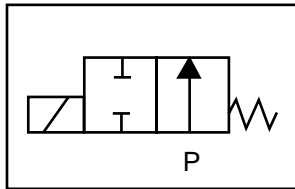

Energized

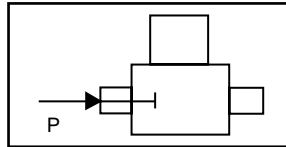

De-Energized

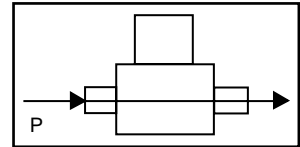

Pipe Size NPT	Orifice Size IN	C _v	Minimum	Operating Pressure Differential (psi)								Max Fluid Temp. °F	Seal Material	Power Consumption (Watts)		Model Code (120V/60HZ — 110V/50HZ Shown)
				Maximum										AC	DC	
				Air/Gas		Water		Light Oil		Steam*	AC			DC	AC	DC
3/4	3/4	6.7	0	200	125	200	125	—	—	—	295	EPR	11	10	S202GF02E7EG5	
	3/4	6.7	0	200	125	200	125	200	125	—	180	Nitrile	11	10	S202GF02J7EG5	
	3/4	6.7	0	200	125	200	125	200	125	—	230	Viton	11	10	S202GF02L7EG5	
	3/4	6.7	0	—	—	—	—	—	—	50*	295	EPR	11	—	S202GH02E7EG5	

* Class H Coil Recommended for Steam and Other High Temperature Applications

Part Numbering

1	2	3	4	5	6	7	8	9	10	11	12	13
S	2	0	2	G	F	0	2	E	7	E	G	5
Series			Operating Mode	Housing*	Coil Class*	Voltage*		Seal Material	Body Material	Pipe Connection	Orifice Size	
S20			2: Normally Open	G: Conduit	F: Class F H: Class H	02: 120/60 110/50		E: EPR J: Nitrile L: Viton	7: 316 SS	E: 3/4" NPT	G5: 3/4"	
* See the "Engineering Guide" for additional voltages, variations and options.												

Coil Data

Coil Family	
Type	Size
All	S4

Frequency (Hz)	60	50
Nominal Power (VA)	Inrush	46
	Holding	22

GC Valves Customer Service: 800-828-0484 (7:30am to 4pm ET) or 800-582-4232 (7:30am to 4pm PT)

- 3/4" NPT
- Stainless Steel Body
Type 316
- 2-Way Piloted Diaphragm
- Normally Open

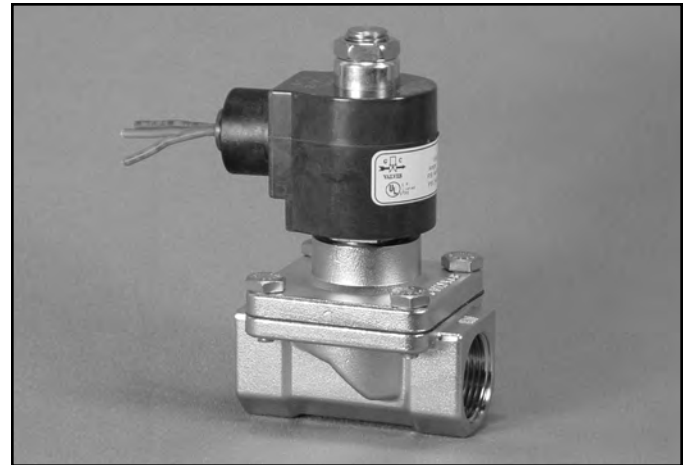

Materials	Seals:	Nitrile, Viton®, Ethylene Propylene
	Orifice:	Pilot: Stainless Steel Main: Stainless Steel Ø 3/4"
Electrical	Standard Housing:	Encapsulated Waterproof Conduit (NEMA 4/4X)
	Optional Housings:	Metallic Conduit, Explosion-proof (NEMA 7), Grommet, Open Frame, Junction Box (single or dual knockouts), DIN; Contact GC Valves Customer Service for others.
	Standard Voltages:	24, 120, 240 AC 60 Hz; 50 Hz available 6, 12, 24 DC; Contact GC Valves Customer Service for Additional Voltages.
	Voltage Tolerance:	±10% of applicable voltage
	Coil Classes:	F, H, N
	Standard Lead Length:	24 inch
Operating Temperature	Ambient (Nominal):	32°F to 125°F
Mounting	Position:	Any
Approvals*	Agency:	UL Listed, UL Recognized, CSA Approved

* Not available for all variations

© Registered Trademark of DuPont Co.

Dimensions/Weight

Weight (lbs.)

3.3

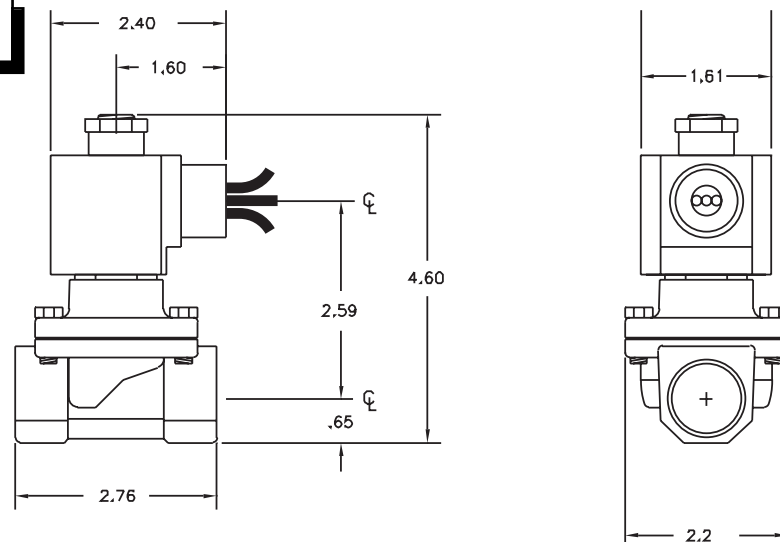

GC Valves Customer Service: 800-828-0484 (7:30am to 4pm ET) or 800-582-4232 (7:30am to 4pm PT)



S212 – 3/4" NPT, Stainless Steel Body, Type 316, Normally Open

Valve Selection List

Normally Open

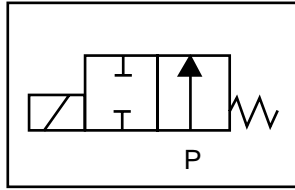

Energized

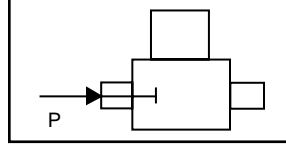

De-Energized

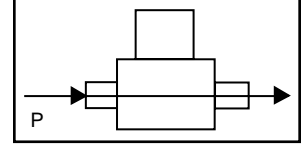

Pipe Size NPT	Orifice Size IN	C _v	Minimum	Operating Pressure Differential (psi)								Max Fluid Temp. °F	Seal Material	Power Consumption (Watts)		Model Code (120V/60HZ — 110V/50HZ Shown)
				Maximum										AC	DC	
				Air/Gas		Water		Light Oil		Steam*						
				AC	DC	AC	DC	AC	DC	AC	DC			AC	DC	AC
3/4	3/4	6.7	3	200	140	200	125	—	—	—	—	295	EPR	11	10	S212GF02E7EG5
	3/4	6.7	3	200	140	200	125	200	125	—	—	180	Nitrile	11	10	S212GF02J7EG5
	3/4	6.7	3	200	140	200	125	200	125	—	—	230	Viton	11	10	S212GF02L7EG5
	3/4	6.7	3	—	—	—	—	—	—	50*	50*	295	EPR	11	10	S212GH02E7EG5

* Class H Coil Recommended for Steam and Other High Temperature Applications

Part Numbering

1	2	3	4	5	6	7	8	9	10	11	12	13
S	2	1	2	G	F	0	2	E	7	E	G	5
Series			Operating Mode	Housing*	Coil Class*	Voltage*		Seal Material	Body Material	Pipe Connection	Orifice Size	
S21			2: Normally Open	G: Conduit	F: Class F H: Class H	02: 120/60 110/50		E: EPR J: Nitrile L: Viton	7: 316 SS	E: 3/4" NPT	G5: 3/4"	
* See the "Engineering Guide" for additional voltages, variations and options.												

Coil Data

Coil Family	
Type	Size
ALL	S4

Frequency (Hz)	60	50	
Nominal Power (VA)	Inrush	46	46
	Holding	22	25

GC Valves Customer Service: 800-828-0484 (7:30am to 4pm ET) or 800-582-4232 (7:30am to 4pm PT)