



OEM – NFPA Air Cylinders



Features

- **Long life lubrication**
Special bushing provides self lubrication of piston rod. Factory lube is Magnalube-G®.
- **High quality, long service life:**
Hard anodized aluminum cylinder tubes offer high corrosion resistance and low internal friction.
- **Wide range of NFPA interchangeable mounting configurations:**
Mounting dimensions are in accordance with ANSI (NFPA) T3.6.7 R2-1996, fluid power systems and products- square head industrial cylinders- mounting dimensions.

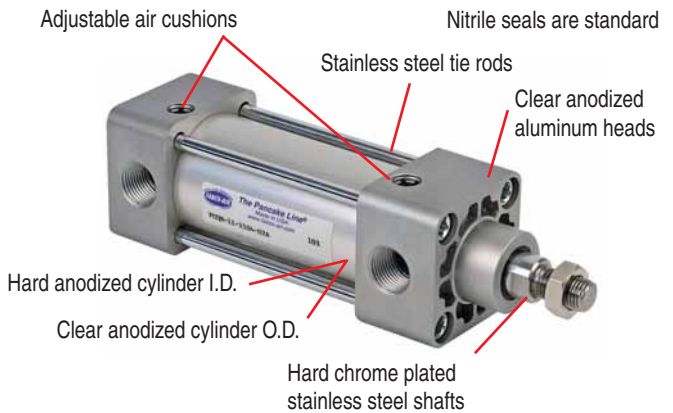

✓ **Adjustable air cushions are standard.**
✓ **Magnetic pistons are standard.**

Specifications

Model	FCQN				
Bore (inch)	1 1/2"	2"	2 1/2"	3 1/4"	4"
Tube ID (mm)	40	50	63	80	100
Port size	3/8 NPT			1/2 NPT	
Medium	Air				
Max. operating pressure	140 PSI				
Min. operating pressure	7 PSI				
Ambient temperature	-5° to 60° C; 23° to 140° F				
Piston position sensors	See page 3				

Standard strokes

Bore	Stroke (Inch)
1 1/2"	1, 2, 3, 4, 5, 6, 8, 10
2", 2 1/2"	1, 2, 3, 4, 5, 6, 8, 10
3 1/4", 4"	1, 2, 3, 4, 5, 6, 8, 10

For longer strokes or intermediate strokes not shown, please consult factory

Piston areas

Bore	1 1/2"	2"	2 1/2"	3 1/4"	4"
Extend in ²	1.95	3.04	4.83	7.79	12.17
Retract in ²	1.64	2.73	4.52	7.01	11.39

How to Order

Model Number

FCQN - 11 - 32S4 - 06A - □

Rod

- 11 . . Single rod
- 21 . . Double rod

Bore

- 15 = 1-1/2
- 20 = 2
- 25 = 2-1/2
- 32 = 3-1/4
- 40 = 4

Order Code

NFPA Mounting

Mounting

- F1MF1 Head rectangular flange
- F2MF2 Cap rectangular flange
- P2MP2 Detachable clevis
- T4MT4 Mid trunnion
- X2MX2 Extended tie rods cap end
- X3MX3 Extended tie rods head end
- S1MS1 Angle mount
- S4MS4 Bottom tapped, flush mount

Options

V . . Viton® seals

Stroke Fractional inches

- A = 0"
- E = 1/4"
- I = 1/2"
- M = 3/4"

Stroke Full inches

- 00 0"
- 01 1"
- 02 2"
- 03 3"
-
- 10 10"

Sensors

See page 3

Cord sets

See page 3

Accessories

See page 3

Seal Kits

See page 7

See pricing on following pages

Magnetic Sensors (Order separately)

Temperature Range: -20° to + 80°C (-4° to + 176°F)

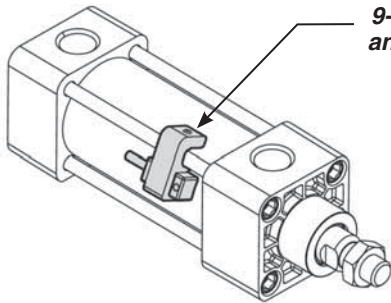

9-2A197 Series Sensor and 800-200-000 Clamp

Bore	A	B
1 1/2"	1.10	1.47
2"	1.49	1.68
2 1/2"	1.66	1.86
3 1/4"	1.87	2.13
4"	2.15	2.42

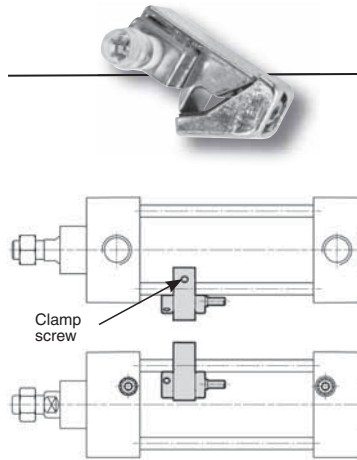
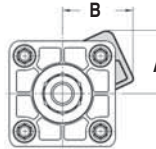

Warning! – Do not exceed sensor ratings. Permanent damage to sensor may occur. Power supply polarity **MUST** be observed for proper operation of sensors. Wiring diagrams included with each sensor.



Cordsets for 9-2A197 Series Quick Disconnect Sensors

Length	1 Meter	2 Meter	5 Meter
Part No.	CFC-1M	CFC-2M	CFC-5M
Price	\$15.05	\$16.85	\$21.30

LED Lighted Magnetic Piston Position Sensors: Bores 1-1/2" – 4"					
Product	9 ft. Prewired P/N	Price	Quick Discon. P/N	Price	Electrical Characteristics
Reed Switch	9-2A197-1004	\$27.10	9-2A197-1304	\$36.60	5-120 VDC/VAC, 0.5 Amp Max., 10 Watt Max., SPST N.O., 3.5 Voltage Drop
Electronic	9-2A197-1033	33.65	9-2A197-1333	43.15	Sourcing, PNP, 6-24 VDC, 0.5Amp Max., 1.0 Voltage Drop
Electronic	9-2A197-1034	33.65	9-2A197-1334	43.15	Sinking, NPN, 6-24VDC, 0.5Amp Max., 1.0 Voltage Drop

9-2A197 Series Sensor Mounting Clamps – Part Number 800-200-000 – Price \$ 8.10

Accessories (Order separately)

Rod Clevis

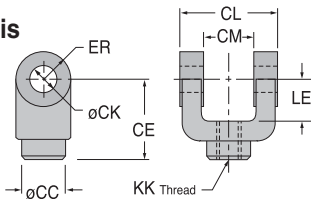

Rod Clevis (Inch)										
Bore	Part No.	Price	CC	CE	CK	CL	CM	ER	KK	LE
1 1/2" ~ 2 1/2"	FCQNC -7/16-20	\$13.65	0.87	1.50	0.50	1.75	0.77	0.50	7/16-20	0.75
3 1/4" ~ 4"	FCQNC -3/4-16	17.25	1.34	2.38	0.75	2.50	1.27	0.75	3/4-16	1.25

Rod Eye

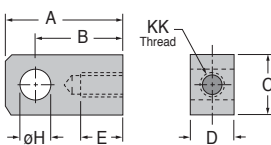

Rod Eye (Inch)									
Bore	Part No.	Price	A	B	C	D	E	H	KK
1 1/2" ~ 2 1/2"	FCQNE -7/16-20	\$12.70	2.00	1.50	1.00	0.75	0.75	0.50	7/16-20
3 1/4" ~ 4"	FCQNE -3/4-16	17.45	2.81	2.06	1.50	1.25	1.13	0.75	3/4-16

Pivot Pin

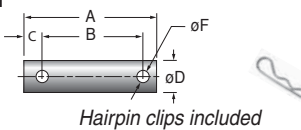

Pivot Pin (Inch)							
Bore	Part No.	Price	A	B	C	D	F
1 1/2" ~ 2 1/2"	FCQNP -0.500	\$4.05	2.36	1.95	0.20	0.50	0.16
3 1/4" ~ 4"	FCQNP -0.750	7.65	3.13	2.74	0.19	0.75	0.20

Rod Alignment Couplers

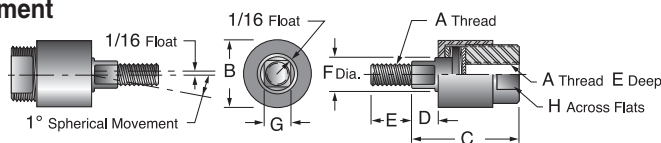

Rod Alignment Couplers (Inch)											
Bore	Part No.	Price	A	B	C	D	E	F	G	H	Max. Pull Lbs.
1 1/2" ~ 2 1/2"	NCP -7/16-20	\$ 52.25	7/16-20	1 1/4	2	1/2	3/4	5/8	1/2	1	2,535
3 1/4" ~ 4"	NCP -3/4-16	68.65	3/4-16	1 3/4	2 5/16	1/2	1 1/8	31/32	1 3/16	1 1/2	8,750



Single Rod Cylinder
S4 Mount - bottom tapped
 with sleeve nuts at both ends
 Order Codes 11, S4

Code 11, S4 - Price

Bore	Base Price	Price/inch	Viton adder
1 1/2"	\$76.75	\$2.55	\$51.20
2"	83.30	2.80	62.00
2 1/2"	90.95	3.05	72.80
3 1/4"	154.50	3.95	105.35
4"	170.85	4.70	134.45

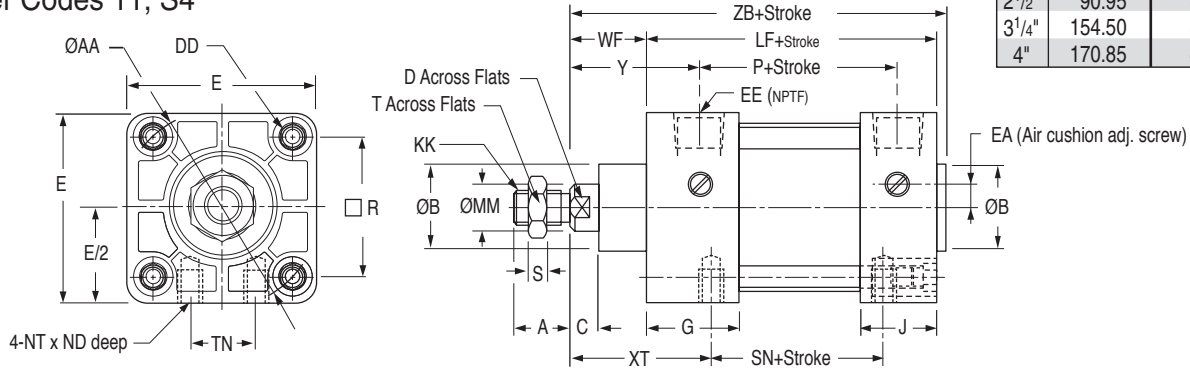

S4 Mount, Single Rod (inches)

Bore	A	AA	B	C	D	DD	E	EA	EE	G	J	KK	LF	MM	ND	NT	P	R	S	SN	T	TN	WF	XT	Y	ZB
1 1/2"	3/4	2.02	1 1/8	3/8	9/16	1/4-28	2	0.32	3/8	1.26	1.01	7/16-20	3.63	5/8	9/32	1/4-20	2.36	1.43	0.26	2.250	0.69	0.625	1	1 15/16	1.71	4.75
2"	3/4	2.60	1 1/8	3/8	9/16	5/16-24	2 1/2	0.43	3/8	1.26	1.06	7/16-20	3.63	5/8	7/16	5/16-18	2.40	1.84	0.26	2.250	0.69	0.875	1	1 15/16	1.71	4.75
2 1/2"	3/4	3.10	1 1/8	3/8	9/16	5/16-24	3	0.47	3/8	1.30	1.06	7/16-20	3.75	5/8	19/32	3/8-16	2.48	2.19	0.26	2.375	0.69	1.250	1	1 15/16	1.75	4.88
3 1/4"	1 1/8	3.90	1 1/2	1/2	7/8	3/8-24	3 3/4	0	1/2	1.57	1.18	3/4-16	4.25	1	5/8	1/2-13	2.72	2.76	0.42	2.625	1.12	1.500	1 3/8	2 7/16	2.34	5.83
4"	1 1/8	4.70	1 1/2	1/2	7/8	3/8-24	4 1/2	0	1/2	1.57	1.18	3/4-16	4.25	1	5/8	1/2-13	2.72	3.32	0.42	2.625	1.12	2.062	1 3/8	2 7/16	2.34	5.83

Double Rod Cylinder
S4 Mount - bottom tapped
 with sleeve nuts at both ends
 Order Codes 21, S4



Code 21, S4 - Price

Bore	Base Price	Price/inch	Viton adder
1 1/2"	\$115.05	\$ 3.05	\$51.20
2"	129.20	3.60	62.00
2 1/2"	140.10	4.05	72.80
3 1/4"	224.50	4.95	105.35
4"	252.85	6.10	134.45

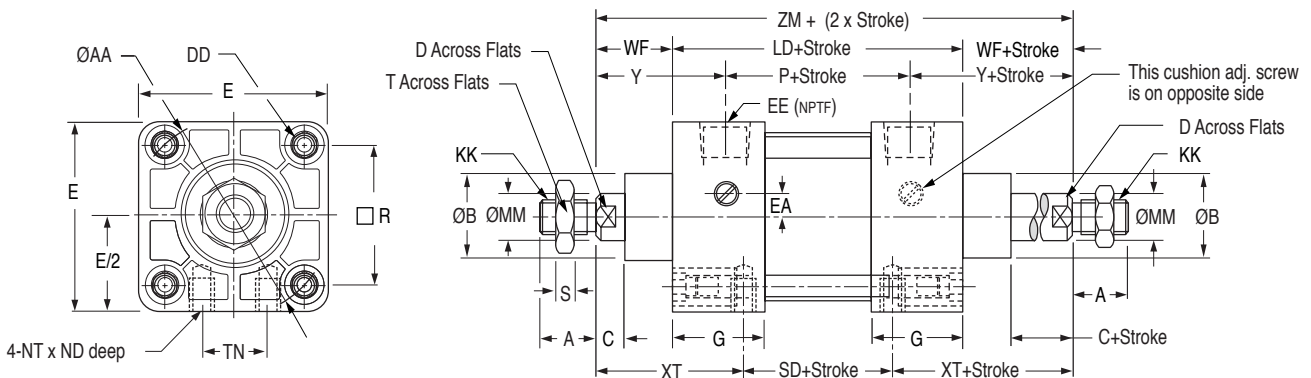

S4 Mount, Double Rod (inches)

Bore	A	AA	B	C	D	DD	E	EA	EE	G	KK	LD	MM	ND	NT	P	R	S	SD	T	TN	WF	XT	Y	ZM
1 1/2"	3/4	2.02	1 1/8	3/8	9/16	1/4-28	2	0.32	3/8	1.26	7/16-20	3.78	5/8	9/32	1/4-20	2.36	1.43	0.26	1.90	0.69	0.625	1	1 15/16	1.71	5.78
2"	3/4	2.60	1 1/8	3/8	9/16	5/16-24	2 1/2	0.43	3/8	1.26	7/16-20	3.82	5/8	7/16	5/16-18	2.40	1.84	0.26	1.94	0.69	0.875	1	1 15/16	1.71	5.82
2 1/2"	3/4	3.10	1 1/8	3/8	9/16	5/16-24	3	0.47	3/8	1.30	7/16-20	3.98	5/8	19/32	3/8-16	2.48	2.19	0.26	2.10	0.69	1.250	1	1 15/16	1.75	5.98
3 1/4"	1 1/8	3.90	1 1/2	1/2	7/8	3/8-24	3 3/4	0	1/2	1.57	3/4-16	4.64	1	5/8	1/2-13	2.72	2.76	0.42	2.52	1.12	1.500	1 3/8	2 7/16	2.34	7.40
4"	1 1/8	4.70	1 1/2	1/2	7/8	3/8-24	4 1/2	0	1/2	1.57	3/4-16	4.64	1	5/8	1/2-13	2.72	3.32	0.42	2.52	1.12	2.062	1 3/8	2 7/16	2.34	7.40

Weights – Pounds

CYLINDERS				
Model	FCQN-11		FCQN-21	
	Bore	Basic Weight	per Inch of Stroke	Basic Weight
1 1/2"	1.49	0.17	2.12	0.26
2"	2.16	0.21	2.80	0.30
2 1/2"	2.94	0.22	3.64	0.37
3 1/4"	5.53	0.44	6.82	0.66
4"	7.28	0.49	9.29	0.71

MOUNTS				
Model	Flange Mount	Trunnion Mount	Angle Mount	Clevis Mount
	Bore	Flange Mount	Trunnion Mount	Angle Mount
1 1/2"	0.54	1.22	0.35	0.50
2"	0.89	1.42	0.53	0.83
2 1/2"	1.27	1.85	0.66	1.15
3 1/4"	3.10	2.42	1.40	2.87
4"	4.44	3.20	2.11	4.01

ACCESSORIES			
Model	Rod Clevis	Rod Eye	Pivot Pin & Clips
	Bore	Rod Clevis	Rod Eye
1 1/2"	0.45	0.33	0.14
2"	0.45	0.33	0.14
2 1/2"	0.45	0.33	0.14
3 1/4"	1.46	1.15	0.39
4"	1.46	1.15	0.39

F1 Mount – Head Rectangular Flange

Order Code F1

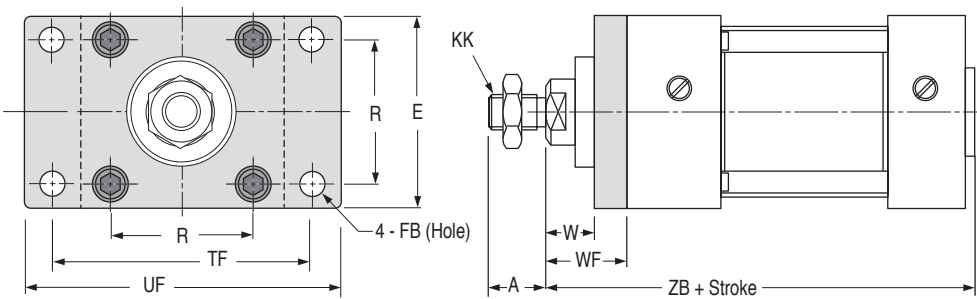

F1 Mount (inches)

Bore	A	E	FB	KK	R	TF	UF	W	WF	ZB	Price Adder
1 1/2"	3/4	2	0.25	7/16-20	1.43	2.75	3.38	5/8	1	4.75	\$19.10
2"	3/4	2 1/2	0.31	7/16-20	1.84	3.38	4.13	5/8	1	4.75	21.65
2 1/2"	3/4	3	0.31	7/16-20	2.19	3.88	4.63	5/8	1	4.88	24.40
3 1/4"	1 1/8	3 3/4	0.38	3/4-16	2.76	4.68	5.50	3/4	1 3/8	5.83	32.05
4"	1 1/8	4 1/2	0.38	3/4-16	3.32	5.44	6.25	3/4	1 3/8	5.83	36.95

F1 Mount Kit (If ordered separately)

Part No.	Price
FCQN-F1-15	\$19.10
FCQN-F1-20	21.65
FCQN-F1-25	24.40
FCQN-F1-32	32.05
FCQN-F1-40	36.95

Includes fasteners to add F1 mount to cylinders with S4 mounting style.

F2 Mount – Cap Rectangular Flange

Order Code F2

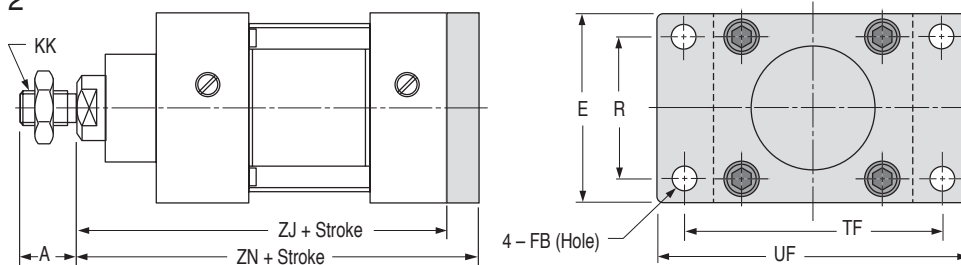

F2 Mount (inches)

Bore	A	E	FB	KK	R	TF	UF	ZJ	ZN	Price Adder
1 1/2"	3/4	2	0.25	7/16-20	1.43	2.75	3.38	4.63	5.00	\$19.10
2"	3/4	2 1/2	0.31	7/16-20	1.84	3.38	4.13	4.63	5.00	21.65
2 1/2"	3/4	3	0.31	7/16-20	2.19	3.88	4.63	4.75	5.13	24.40
3 1/4"	1 1/8	3 3/4	0.38	3/4-16	2.76	4.68	5.50	5.63	6.25	32.05
4"	1 1/8	4 1/2	0.38	3/4-16	3.32	5.44	6.25	5.63	6.25	36.95

Use F1 Mount Kit for F2 Mount

Part No.	Price
FCQN-F1-15	\$19.10
FCQN-F1-20	21.65
FCQN-F1-25	24.40
FCQN-F1-32	32.05
FCQN-F1-40	36.95

Mounting kit for F2 mount is the same as above. Fasteners are included.

T4 Mount
 Mid Trunnion
 Order Code T4

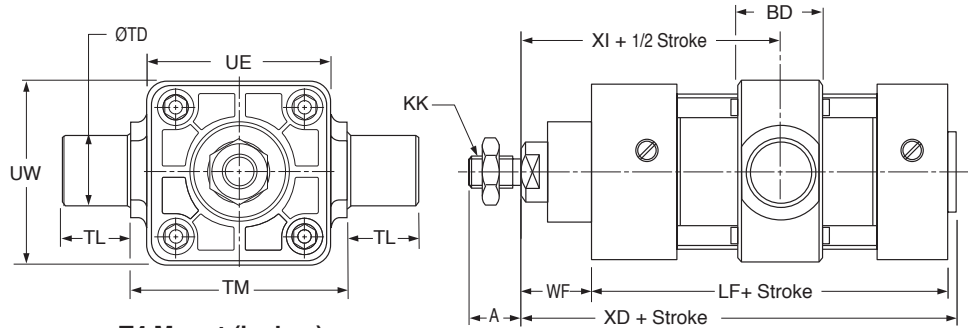

T4 Mount (inches)

Bore	A	BD	KK	LF	TD	TL	TM	UE	UW	WF	XD	XI	Price Adder
1 1/2"	3/4	1.04	7/16-20	3.63	1	1	2.50	2.11	2.28	1	4.75	2.89	\$43.35
2"	3/4	1.04	7/16-20	3.63	1	1	3.00	2.60	2.60	1	4.75	2.91	45.55
2 1/2"	3/4	1.10	7/16-20	3.75	1	1	3.50	3.09	3.23	1	4.88	2.99	52.75
3 1/4"	1 1/8	1.18	3/4-16	4.25	1	1	4.50	3.70	4.17	1 3/8	5.83	3.70	62.15
4"	1 1/8	1.22	3/4-16	4.25	1	1	5.25	4.49	4.96	1 3/8	5.83	3.74	75.85

X2 Mount
 Cap Extended Tie Rods
 Order Code X2

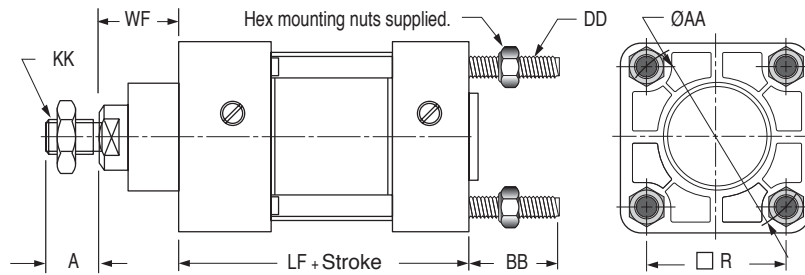

X2 Mount (inches)

Bore	A	AA	BB	DD	KK	LF	R	WF	Price Adder
1 1/2"	3/4	2.02	1.000	1/4-28	7/16-20	3.63	1.43	1	\$4.70
2"	3/4	2.60	1.125	5/16-24	7/16-20	3.63	1.84	1	4.85
2 1/2"	3/4	3.10	1.125	5/16-24	7/16-20	3.75	2.19	1	4.90
3 1/4"	1 1/8	3.90	1.375	3/8-24	3/4-16	4.25	2.76	1 3/8	6.90
4"	1 1/8	4.70	1.375	3/8-24	3/4-16	4.25	3.32	1 3/8	11.95

X3 Mount
 Head Extended Tie Rods
 Order Code X3

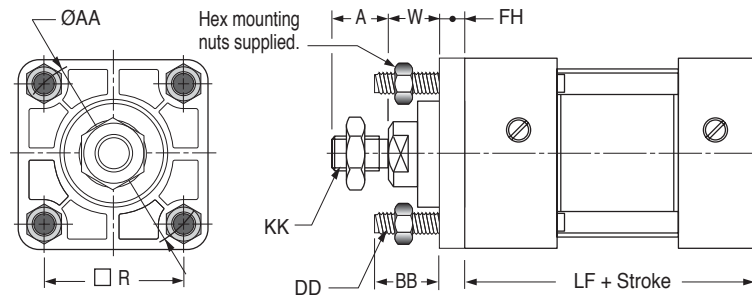

X3 Mount (inches)

Bore	A	AA	BB	DD	FH	KK	LF	R	W	Price Adder
1 1/2"	3/4	2.02	1.000	1/4-28	3/8	7/16-20	3.63	1.43	5/8	\$13.85
2"	3/4	2.60	1.125	5/16-24	3/8	7/16-20	3.63	1.84	5/8	15.50
2 1/2"	3/4	3.10	1.125	5/16-24	3/8	7/16-20	3.75	2.19	5/8	17.90
3 1/4"	1 1/8	3.90	1.375	3/8-24	5/8	3/4-16	4.25	2.76	3/4	24.10
4"	1 1/8	4.70	1.375	3/8-24	5/8	3/4-16	4.25	3.32	3/4	28.30

P2 Mount Detachable Rear Clevis

Order Code P2 (Pivot pins & hairpin clips included.)

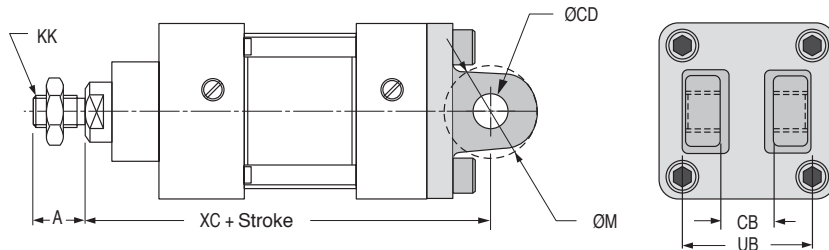

P2 Mount (inches)

Bore	A	CB	CD	KK	M	UB	XC	Price Adder
1 1/2"	3/4	0.78	0.50	7/16 - 20	1.24	1.75	5.38	\$19.35
2"	3/4	0.78	0.50	7/16 - 20	1.24	1.75	5.38	20.85
2 1/2"	3/4	0.78	0.50	7/16 - 20	1.24	1.75	5.50	21.40
3 1/4"	1 1/8	1.28	0.75	3/4 - 16	1.88	2.50	6.88	28.75
4"	1 1/8	1.28	0.75	3/4 - 16	1.88	2.50	6.88	31.50

P2 Mount Kit (If ordered separately)

Part No.	Price
FCQN-P2-15	\$19.35
FCQN-P2-20	20.85
FCQN-P2-25	21.40
FCQN-P2-32	28.75
FCQN-P2-40	31.50

Includes fasteners, pin and clips to add P2 mount to cylinders with S4 mounting style.

S1 Mount

Angle Mount

Order Code S1

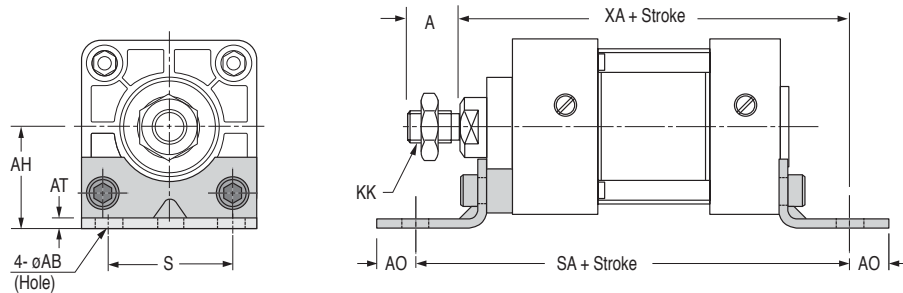

S1 Mount (inches)

Bore	A	AB	AH	AO	AT	KK	S	SA	XA	Price Adder
1 1/2"	3/4	3/8	1.188	7/16	1/8	7/16-20	1.25	6.00	5.63	\$15.90
2"	3/4	3/8	1.438	9/16	1/8	7/16-20	1.75	6.00	5.63	16.20
2 1/2"	3/4	3/8	1.625	9/16	1/8	7/16-20	2.25	6.13	5.75	17.30
3 1/4"	1 1/8	1/2	1.938	3/4	11/64	3/4-16	2.75	7.38	6.88	21.95
4"	1 1/8	1/2	2.250	3/4	15/64	3/4-16	3.50	7.38	6.88	24.95

S1 Mount Kit (If ordered separately)

Part No.	Price
FCQN-S1-15	\$15.90
FCQN-S1-20	16.20
FCQN-S1-25	17.30
FCQN-S1-32	21.95
FCQN-S1-40	24.95

Includes fasteners to add S1 mount to cylinders with S4 mounting style.

Seal Kits

Each kit includes materials for both single and double rod cylinders

Bore	Nitrile Kits		Viton Kits	
	Part No.	Price	Part No.	Price
1 1/2"	FCQN-15-SK	\$8.15	FCQN-15-SKV	\$51.20
2"	FCQN-20-SK	8.30	FCQN-20-SKV	62.00
2 1/2"	FCQN-25-SK	8.80	FCQN-25-SKV	72.80
3 1/4"	FCQN-32-SK	10.95	FCQN-32-SKV	105.35
4"	FCQN-40-SK	12.40	FCQN-40-SKV	134.45

Fabco-Air Product Catalog Library

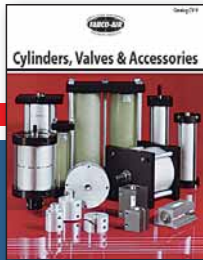

Cylinders, Valves and Accessories
 Catalog #CV9



Pancake® II Air Cylinders
 Catalog #Pan2-2



Square Pancake® II
 Air Cylinders
 Catalog #SqPan2



ISO 6431 Cylinders
 Catalog #FAQR-09



Twin Rod, Non-Rotating
 Air Cylinders - Catalogs
 #FDf-09 & #FDXs-09



High Closing Force
 Angular Grippers
 Catalog #FKHC-10



Multi-Power® Air Presses
 Catalog #FP16

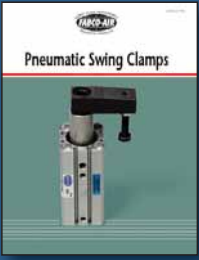

Swing Clamps
 Catalog #SC-DB04

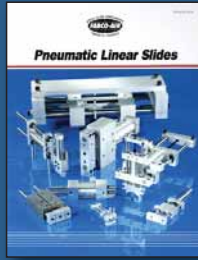

Linear Slides - 6 Families
 Catalog #LS-03



Compact Finger Slides
 Catalog #FDH-10

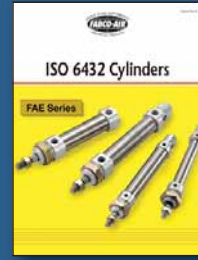

ISO 6432 Cylinders
 Catalog #FAE-09

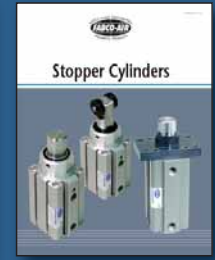

Stopper Cylinders
 Catalog #ST-SC

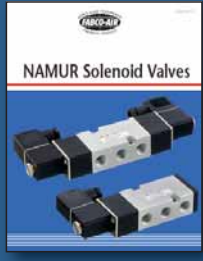

NAMUR Solenoid Valves
 Catalog #FVEN-10

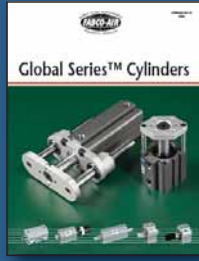

Global Series™ Metric
 Air Cylinders
 Catalog #GC-15

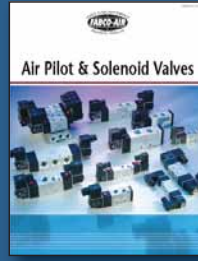

Air Pilot and
 Solenoid Valves
 Catalog #FVA.E-09

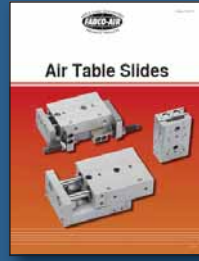

Air Table Slides
 Catalog #FGXS-10

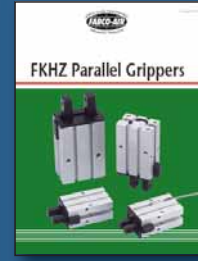

Wide & Narrow Parallel
 Grippers - Catalogs
 #FKHZ-10 & #FKHQ-10



Toggle Type
 Angular Grippers
 Catalog #FKHT-10

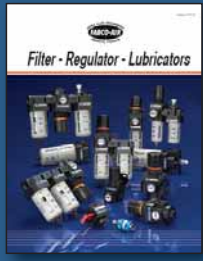

Modular Air Preparation
 System - FRLs
 Catalog #FRL-06

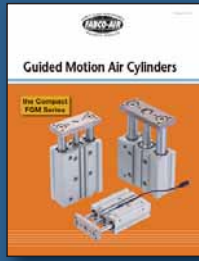

Guided Motion
 Air Cylinders
 Catalog #FGM-10

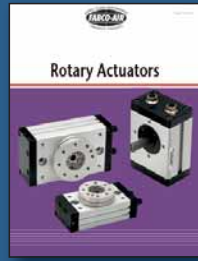

Pneumatic Rotary
 Actuators
 Catalog #FRA.C-09

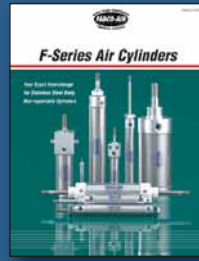

Stainless Steel Body
 Air Cylinders
 Catalog #SSB-03



Pneumatic & Hydraulic
 Swing Clamps
 Catalog #FML.H



Wide Opening
 Parallel Grippers
 Catalog #FKHL-10



Original Pancake®
 Air Cylinders
 Catalog #CV9

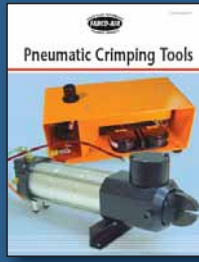

Pneumatic
 Crimping Tools
 Catalog #FCT-JY07



Magnetically Coupled
 Rodless Air Cylinders
 Catalog #FGYBR-11

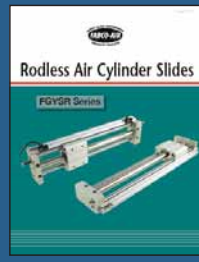

Magnetically Coupled
 Rodless Slides
 Catalog #FGYS-11



Angular Grippers
 Catalog #FKA-09



3 Series of Angular &
 Parallel Motion Grippers
 Catalog #GR8