

Valves and Solenoid valves Series 9

5/2 and 5/3-way CC CO

Sizes 1 - 2 - 3

According to the standard ISO 5599/1

2

CONTROL



Series 9 electropneumatically or pneumatically operated valves have been designed with sizes 1, 2 and 3, as recommended by the ISO Standards. The ease of pneumatic and electrical wiring makes these valves extremely flexible.

GENERAL DATA

Operating pressure	max. press. 10 bar (for minimum pressures see descriptions)
Nominal pressure	6 bar
Nominal flow	ISO 1 = 900 NI/min ISO 2 = 1610 NI/min ISO 3 = 4350 NI/min
Operating temperature	0 ÷ 60°C (with dry air at -20°C)
Fluid	filtered air, without lubrication. If lubricated air is used, it is recommended to use ISOVG32 oil and to never interrupt the lubrication.
Electropneumatic interface	according CNOMO Standards

CODING EXAMPLE

9 | **5** | **1** | **-** | **C** | **1** | **B** | **-** | **P16** | **-** | **23** | **-** | **U** | **7** | **7**

9	SERIES
5	NUMBER OF WAYS - POSITIONS: 5 = 5/2 6 = 5/3 CC 7 = 5/3 CO
1	SIZE: 1 = size 1 2 = size 2 3 = size 3
C	SUB-BASE: C = ISO (manifold outlets) F = ISO (single sub-base, side ports) G = ISO (single sub-base, rear ports) N = ISO (front outlet interface) N1A = (front outlet sub - base)
1	PORTS - OUTLETS: Size 1 = G1/4 Size 2 = G3/8 Size 3 = G1/2
B	NUMBER OF SUB-BASES: A = 1 *B = 2 *C = 3 *D = 4 *E = 5 *F = 6 *G = 7 *H = 8 *K = 9 *L = 10 *M = 11 *N = 12 *P = 13 *R = 14 *S = 15
P 16	ACTUATION: 33 = pneumatic, pneumatic return 34 = pneumatic, differential pneumatic return 35 = pneumatic, mechanical spring return P11 = double solenoid (horizontal solenoids) P15 = single solenoid, spring return (horizontal solenoids) P16 = solenoid, pneumatic spring return (horizontal solenoids)
23	SOLENOID INTERFACE: 23 = A531 - BC2 (Cnomo norm)
U	SOLENOID MATERIAL: U = PET G = PA A8 = PPS H8 = PA 6 VO
7	SOLENOID DIMENSIONS: 7 = 22 x 22 8 = 30 x 30 9 = 22 x 58
7	SOLENOID VOLTAGE: see the solenoids section on page 2.2.35.01

* Complete with two end - blocks Mod. 900-H or 900-HN.

5/2-way solenoid valves, monostable - ISO 1, ISO 2, ISO 3



The Series 9 solenoid valves with an ISO interface, size 1, 2 and 3, which have electropneumatic actuation and spring return, are suitable for mounting on a sub-base.

For electrical actuation, 2 types of solenoid, Mod. A70 and Mod. A80, are available with a wide range of voltages and power consumptions.

The following is supplied:
1x interface seal
4x fixing screws

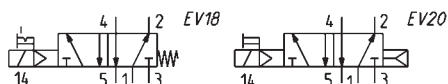
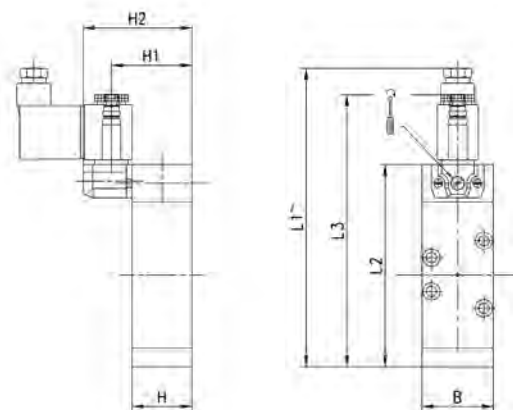

DIMENSIONS										
Mod.	Size ISO	B	L1	L2	L3	H	H1	H2	Min. operating pressure	Symbol
951-000-P15-23	1	38	153	108	146	32	43	58	2,5	EV18
952-000-P15-23	2	51	173	128	166	33	44	59	2,5	EV18
953-000-P15-23	3	65	218	173	211	45	56	71	2,5	EV18
951-000-P16-23	1	38	153	108	146	32	43	58	2,5	EV20
952-000-P16-23	2	51	173	128	166	33	44	59	2,5	EV20
953-000-P16-23	3	65	218	173	211	45	56	71	2,5	EV20

5/2-way, 5/3-way valves, bistable - ISO 1, ISO 2, ISO 3



The Series 9 solenoid valves which have an ISO interface, size 1, 2 and 3, and which have electropneumatic actuation and return are suitable for mounting on a sub-base.

For electrical actuation, 2 types of solenoid, Mod. A70 and Mod. A80, are available with a wide range of voltages and power consumptions.

The following is supplied:
1x interface seal
4x fixing screws

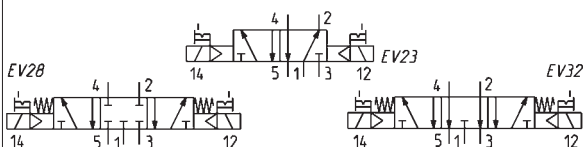
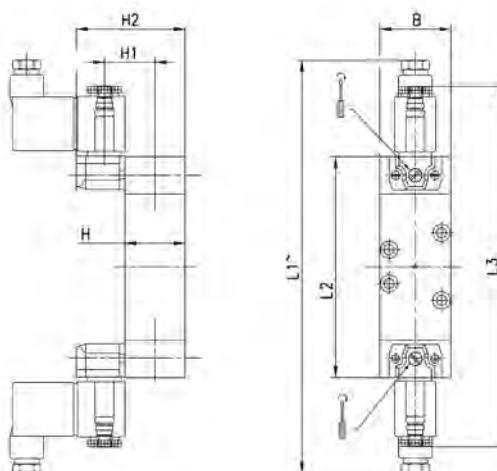

DIMENSIONS										
Mod.	Size ISO	B	L1	L2	L3	H	H1	H2	Min. operating pressure	Symbol
951-000-P11-23	1	38	208	118	194	32	43	58	2,5	EV23
952-000-P11-23	2	51	228	138	214	33	44	59	2,5	EV23
953-000-P11-23	3	65	273	183	259	45	56	71	2,5	EV23
961-000-P11-23	1	38	208	118	194	32	43	58	2,5	EV28
962-000-P11-23	2	51	228	138	214	33	44	59	2,5	EV28
963-000-P11-23	3	65	273	183	259	45	56	71	2,5	EV28
971-000-P11-23	1	38	208	118	194	32	43	58	2,5	EV32
972-000-P11-23	2	51	228	138	214	33	44	59	2,5	EV32
973-000-P11-23	3	65	273	183	259	45	56	71	2,5	EV32

5/2 -way valves, monostable, bistable - ISO 1, ISO 2, ISO 3



The Series 9 valves with ISO interface, size 1, 2 and 3, are available with the following types of actuation:

- pneumatic, with spring return
- pneumatic actuation and differential return
- pneumatic actuation and return

The following is supplied:
1x interface seal
4x fixing screws

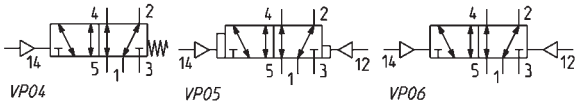
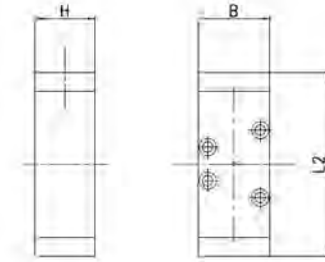

DIMENSIONS						
Mod.	Size ISO	B	L2	H	Min. operating pressure	Symbol
951-000-35	1	38	98	32	2,5	VP04
952-000-35	2	51	118	33	2,5	VP04
953-000-35	3	65	163	45	2,5	VP04
951-000-34	1	38	98	32	2	VP05
952-000-34	2	51	118	33	2	VP05
953-000-34	3	65	163	45	2	VP05
951-000-33	1	38	98	32	2	VP06
952-000-33	2	51	118	33	2	VP06
953-000-33	3	65	163	45	2	VP06

5/3-way valve, monostable, with stable central position - ISO 1, 2, 3



The Series 9 valves with ISO interface, size 1, 2 and 3, are available with pneumatic actuation and central resetting by a spring.

- There are two types of function:
- with closed centres
 - with open centres

The following is supplied:
1x interface seal
4x fixing screws

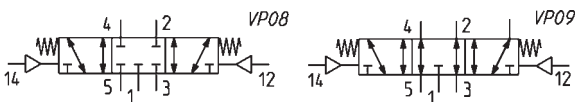
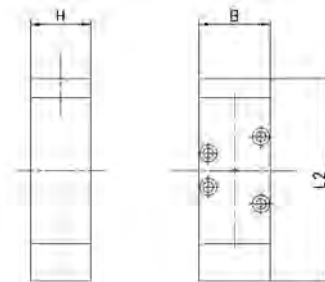

DIMENSIONS						
Mod.	Size ISO	B	L2	H	Min. operating pressure	Symbol
961-000-33	1	38	108	32	2,5	VP08
962-000-33	2	51	128	33	2,5	VP08
963-000-33	3	65	173	45	2,5	VP08
971-000-33	1	38	108	32	2,5	VP09
972-000-33	2	51	128	33	2,5	VP09
973-000-33	3	65	173	45	2,5	VP09

Single sub-base side outlets (VDMA 24345)

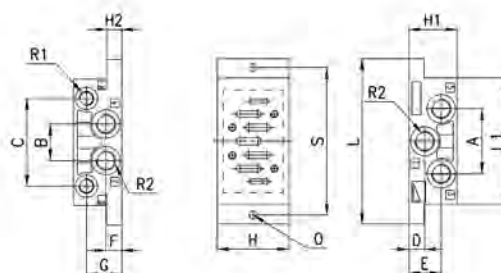

DIMENSIONS

Mod.	Size	A	B	C	D	E	F	G	H	H1	H2	L	L1	O	R1	R2	S
901-F1A	1	43	24	58	21.5	10.5	10.5	23.5	48	32	10	110	84	5.5	G1/8	G1/4	98
902-F2A	2	56	30	74	26	14	14	30	57	40	13	124	95	6.5	G1/8	G3/8	112
903-F3A	3	68	32	90	17	17	17	22	71	32	18	149	119	6.5	G1/8	G1/2	136

Single sub-base with rear outlets (VDMA 24345)

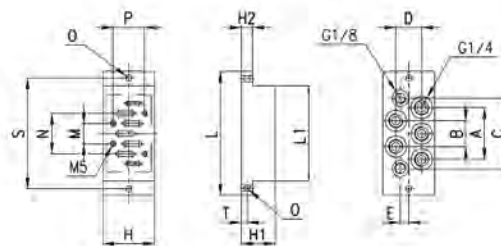

DIMENSIONS

Mod.	Size	A	B	C	D	E	H	H1	H2	L	L1	M	N	O	P	R	R1	R2	S	T
901-G1A	1	46	23	61	23	7.5	46	30	10	110	84	18	36	5.5	28	M5	G1/8	G1/4	98	5
902-G2A	2	56	28	72	28	8	56	35	13	124	95	24	48	6.5	38	M6	G1/8	G3/8	112	6.5
903-G3A	3	68	34	90	34	10	71	32	18	149	119	32	64	6.5	48	M8	G1/8	G1/2	136	9

Manifold sub-base with com. exhausts and inlet (VDMA 24345)

The following is supplied:
 2x fixing screws
 3x O-ring

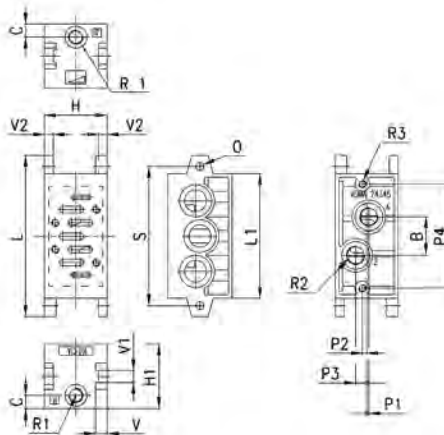

DIMENSIONS

Mod.	Size	B	C	H	H1	L	L1	O	P1	P2	P3	P4	R1	R2	R3	S	V	V1	V2
901-C1A	1	26	8.5	43	44	110	85	5.5	1.5	3	7.5	71	G1/8	G1/4	M5	95	8	8	6
902-C2A	2	30	9	56	45	135	100	6.5	5	3	6	86	G1/8	G3/8	M6	115	11	11	8
903-C3A	3	38	10	71	54	190	140	9	6	3	8	130	G1/8	G1/2	M8	168	13	13	8

Note: complete with fixing screws and O-ring.



End block for manifold sub-base (VDMA 24345)

The following is supplied:
 2x end blocks (1 pair)
 2x fixing screws
 3x OR

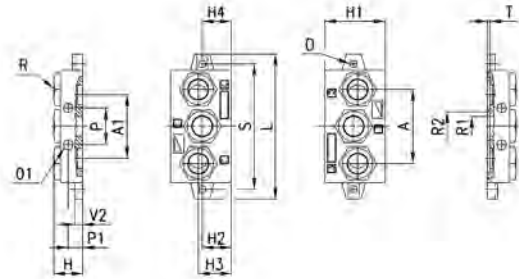

DIMENSIONS																			
Mod.	Size	A	A1	H	H1	H2	H3	H4	L	O	O1	P	P1	R	ØR1	ØR2	S	T	V2
901-H1	1	56	48	22	46	22	25	22	110	5,5	7	28	11	G3/8	15	22,1	95	2	6
902-H2	2	68	63	26	47	23	25	24	135	6,5	9	35	13	G1/2	18,5	28,7	115	2	8
903-H3	3	104	94	30	56	22	25	25	190	9	12	52	15	G1	28	38	168	2,7	8



Interface with front outlets (VDMA 24345)

The following is supplied:
 2x fixing screws
 2x OR

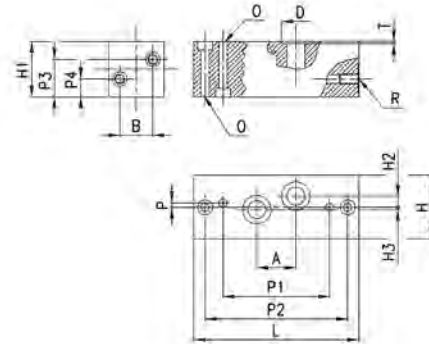

DIMENSIONS																	
Mod.	Size	A	B	D	H	H1	H2	H3	L	O	P	P1	P2	P3	P4	R	T
901-N1	1	26	22	19	42	37	7.5	1.5	110	5.5	3	71	95	25	12	G1/4	1.4
902-N2	2	30	29	23	55	40	6	5	135	6.5	3	86	115	26	14	G3/8	1.4
903-N3	3	38	36	27	70	45	8	6	190	9	3	130	168	29	17	G1/2	1.4



End blocks for manifold bases with front outlets

The following is supplied:
 2x end blocks (1 pair)
 2x fixing screws
 3x OR

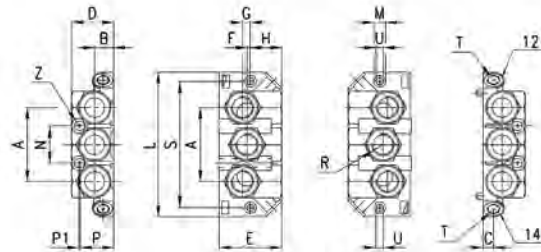

DIMENSIONS																			
Mod.	Size	A	B	C	D	E	F	G	H	L	M	N	P	P1	R	S	T	U	Z
901-HN1	1	56	14.5	8	32	48	2.5	6	24	110	9	28	25.5	1	3/8"	96	G1/8	5.5	3.5

Manifold bases with comm. inlet and exhaust ports and front outlet

The following is supplied:
 2x fixing screws
 3x OR

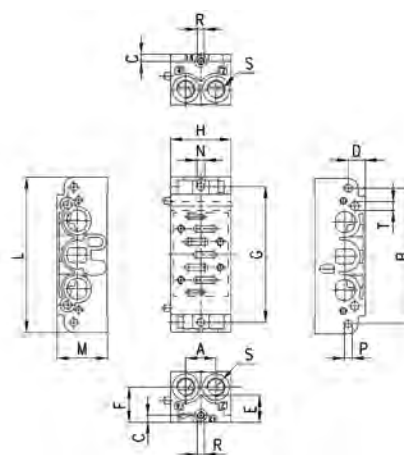

DIMENSIONS																
Mod.	Size	A	B	C	D	E	F	G	H	L	M	N	P	R	S	T
901-N1A	1	21.5	96	5	12	19	25	96	43	110	36	5.5	5.5	M5	G1/4	6.2

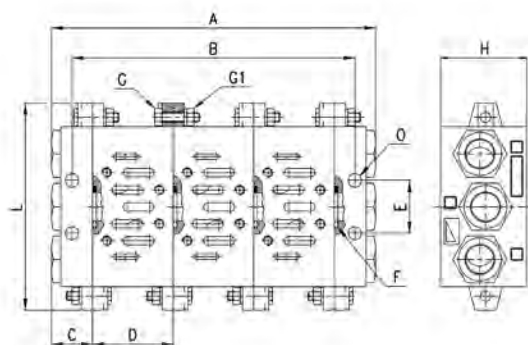
Assembly of manifold sub-base (VDMA 24345)

DIMENSIONS													
Size	A	B	C	D	E	F	OR	UNI 5739 G	UNI 57588 G1	H	L	O	
1	n°D+2C	n°D+C	22	43	28	3068	M5X20	M5	46	110	7		
2	n°D+2C	n°D+C	26	56	35	3093	M6X25	M6	47	135	9		
3	n°D+2C	n°D+C	30	71	52	4125	M8X25	M8	56	190	12		

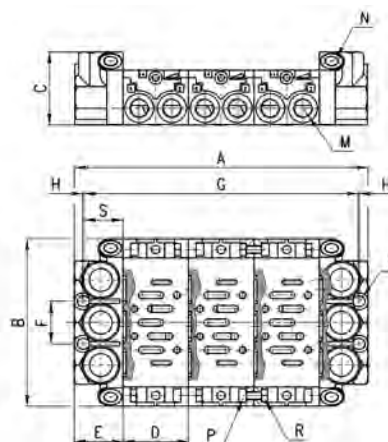
Assembly for front outlet manifold sub-bases

DIMENSIONS														
Size	A	B	C	D	E	F	G	H	L	M	N	UNI 5931 P.	UNI 5588 R	S
1	N° D+2E	110	48	43	32	28	n°D+25	1	3,5	G1/4	G1/8	M5X14	M5	25,5

Cover plate for unused positions

The following is supplied:
 1x seal
 4x screws

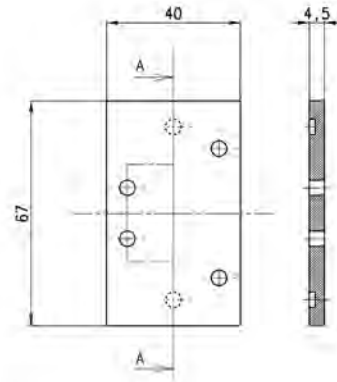

Mod.
901-TP

Mounting example

Separation tap lines 1 - 3 - 5 to be used with manifold type 901C and 902C.

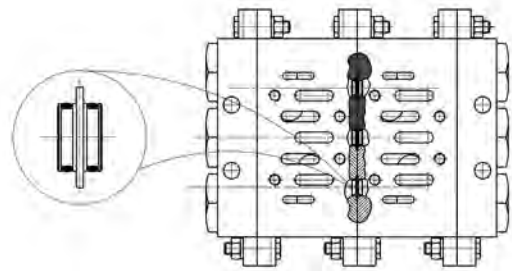

Mod.
901-C1A/TP
902-C2A/TP

Separation joint

Separation joint to be used with manifold type 901N.
 P-R-S plugged.

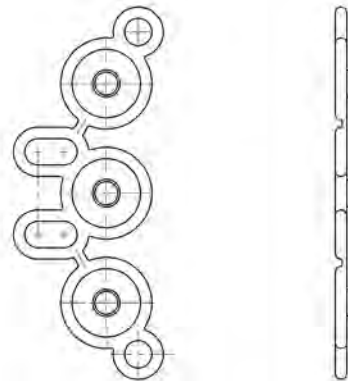

1/3/5 plugged

Mod.
901-N1A/TP

Separation joint

Separation joint to be used with manifold type 901N.
 P plugged.

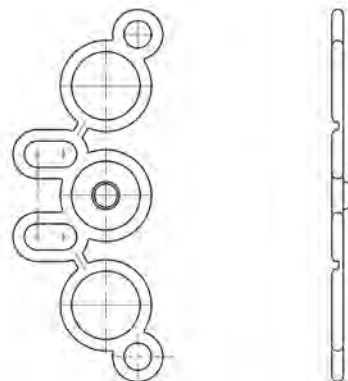

1 plugged

Mod.
901-N1A/TP