

- Sensor in solid state technology
- Shows both flow rate and volume
- Simulation: all outputs signals provided without the need for real flow
- Clean in process (CIP)
- FDA approved

Type 8045 can be combined with...



Type S020
Fitting in
Stainless steel /
Brass / PVC /
PVDF / PP



Type S020
Fitting in
Stainless steel /
PVC / PVDF / PP

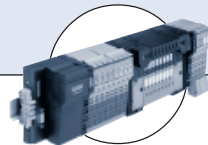

**Type 8644-P
AirLINE**
Valve Island with
electronic I/O



Type 2030
Diaphragm Valve



Type 2712 (8630)
Continuous
TopControl

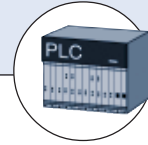

PLC

The Magflowmeter 8045 has been designed for pipes with diameters ranging from 1/4" to 16" and liquids having a conductivity > 20 µS/cm.

The transmitter has a large display, a keyboard and provides 4-20 mA, relay and pulse outputs. The version with a stainless steel sensor has

been designed for applications with high pressures 230 PSI and high temperatures (up to 230°F).

Fitting and sensor data	
Pipe diameter	1/4" (DN 6) to 16" (DN 400)
Measuring range	0.33 ft/s (0.1 m/s) to 32.8 ft/s (10 m/s)
Fitting	S020 (see corresp. data sheet)
Sensor element	Electrodes
Materials wetted parts	
Sensor armature	PVDF or Stainless steel 316L (DIN1.4404)
Electrodes	Stainless steel 316L (DIN1.4404)
Seal	FPM (standard on version with PVDF sensor) EPDM (standard on version with Stainless steel sensor)
Earth ring (PVDF sensor vers.)	Stainless steel 316L (DIN1.4404)
Electrode holder (St. St. sensor vers.)	PEEK

Medium data	
Medium temperature	
PVDF sensor version	32°F (0) up to 176°F (80°C) (dep. on fitting)
Stainless steel sensor version	-13°F (-25) up to 230°F (110°C) (dep. on fitting)
Fluid pressure	
PVDF sensor version	87psi (PN6) (see temperature-pressure diagram)
Stainless steel sensor version	145psi or 230psi (PN10 or PN16) (Depends on temperature and fitting material, see temperature-pressure diagram)
Conductivity	min. 20 µS/cm

Electronic module data	
Accuracy	
Teach-In, manually works calibration	± 2% of measured value ¹⁾ .033 to 32.8 ft/s
Standard K-factor	± 4% of measured value ¹⁾ .033 to 32.8 ft/s
Linearity	± (1% of measured value + 0.1% of FS*)
Repeatability	0.25% of measured value ¹⁾
Voltage supply	18-36 VDC, regulated (3 wires)
Outputs 8045	
Pulse	NPN and PNP, open collector, galvanic insulation, up to 36 VDC, 100 mA max., protected against short-circuits and polarity reversals

Electronic module data (continued)	
Relay (programmable) (option)	2 normally open relays, freely adjustable 250 VAC, 3A or 30 VDC, 3A (resistive load) max. cutting power of 750 VA (resistive load)
Process value	Hysteresis thresholds 4-20 mA, max. load: 1300 Ω at 30 V, 1000 Ω at 24 V, 700 Ω at 18 V
Current consumption	max. 300 mA
Materials	
Housing, Cover (with PVDF sensor version)	PC, (glass fibre reinforced for Housing)
Housing, Cover (with St. St. sensor version)	PPA, glass fibre reinforced
Front panel foil	Polyester
Protection lid	PSU
Electrical connections	Cable gland M 20 x 1.5

General data	
Ambient temperature	14°F (-10°C) to 140°F (60 °C) (operating) -4°F (-20°C) to 140°F (60 °C) (storage)
Relative humidity	< 80%, non condensed
Protection class	IP65
Standards	
EMC	EN 50081-1, 50082-2
Security	EN 61010-2
Vibration	EN 60068-2-6
Shock	EN 60068-2-27
The device also complies with directive N° 97/23/EC about the devices set under pressure, according to the following methods:	
- Fluids of group 1 according to §1.3b of the directive:	PN ≤ 230 PSI and DN < 5"
- Fluids of group 2 according to §1.3b of the directive:	PN ≤ 230 PSI and DN ≤ 8"
It has been designed and manufactured professionally (Article 3.3). The CE mark is not for pressure.	
The CE mark complies with directives 89/336/EC (EMC) and 73/23/EC (LVD).	

¹⁾ In the reference conditions, where: fluid = water, water and ambient temperatures = 20°C, upstream and downstream distances complied with, pipe dimensions adapted.
* FS = Full scale

DTS 1000079057 EN Version: - Status: RL (released | freigegeben | validé) printed: 12.08.2008

Pressure/Temperature diagrams

Please be aware of the fluid pressure-temperature dependence according to the respective fitting+sensor material as shown in the diagrams.

8045 with a PVDF sensor

Depending on the fitting material

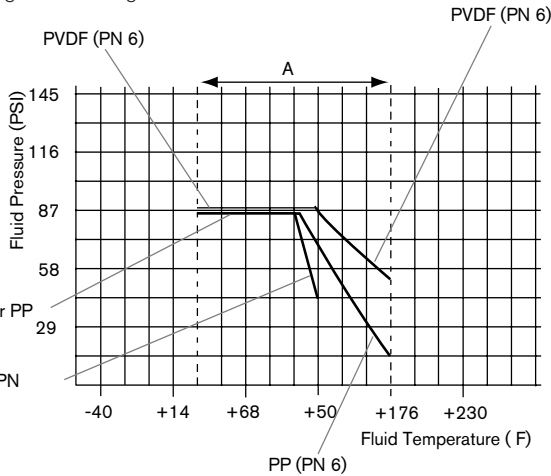

8045 with a stainless steel sensor

Depending on the fitting material

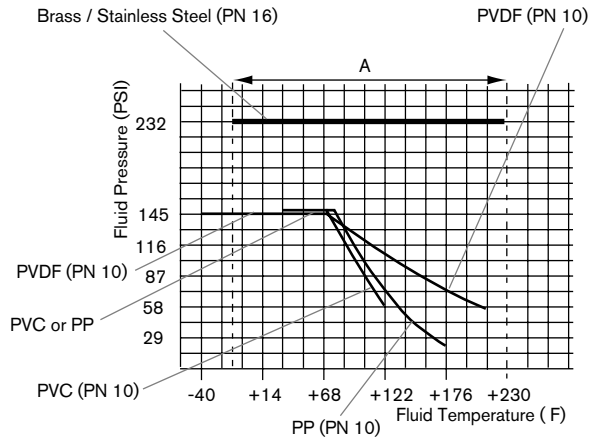

A: Application range for complete device (fitting + transmitter)

Measuring principle

The E-shaped magnetic system inside the sensor induces a magnetic field into the fluid, which is perpendicular to the direction of flow.

Two electrodes are in galvanic contact with the liquid. Based on the Faraday law a voltage can be measured between these electrodes once a liquid (min. conductivity of 20 μ S/cm) flows along the pipe. This voltage is proportional to the flow velocity. Using the K factor for the individual pipe diameter the speed of flow is converted into volume per time.

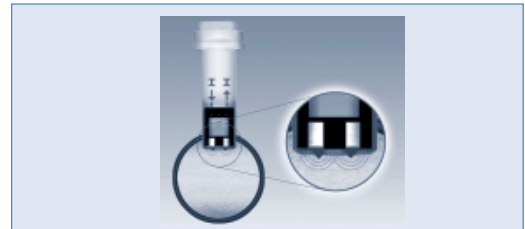

Possible applications

Flow control of fluids, charged or not:

- ▶ Waste water treatment
- ▶ Flow control of drinking water (FDA approval)
- ▶ Laundries: measurement and control of the water consumption
- ▶ Swimming pools: pump protection and flow control
- ▶ Food-processing industry: monitoring of the cleaning cycles (FDA approval)
- ▶ Irrigation

Software main features

- International measuring units
- Choice of the display language
- Teach-In for a better accuracy, or K-factor
- 4-20 mA current output
- Pulse output
- 2 relays (option)
- Filter function
- Reset of the main totalizer
- Simulation mode to adjust Zero and Span and simulate flow in dry-run condition

Display

Large digital display with 8 characters (4 digital characters and 4 alphanumeric characters) indicating:

- the measured flow
- the value of the current output
- the value of the main totalizer
- the value of the daily totalizer



3 keys to go through the menus and program the device

LEDs indicating the relay status

Installation recommendations

A-
The minimum straight upstream (10 x DN) and downstream (3 x DN) distances must be observed.

B-
It is advisable to mount the transmitter at a 45° angle to the horizontal centre of the pipe to avoid having deposits on the electrodes and false measurements due to air bubbles.

C, D and E -
Mount the 8045 transmitter in these ways to obtain an accurate flow measurement.

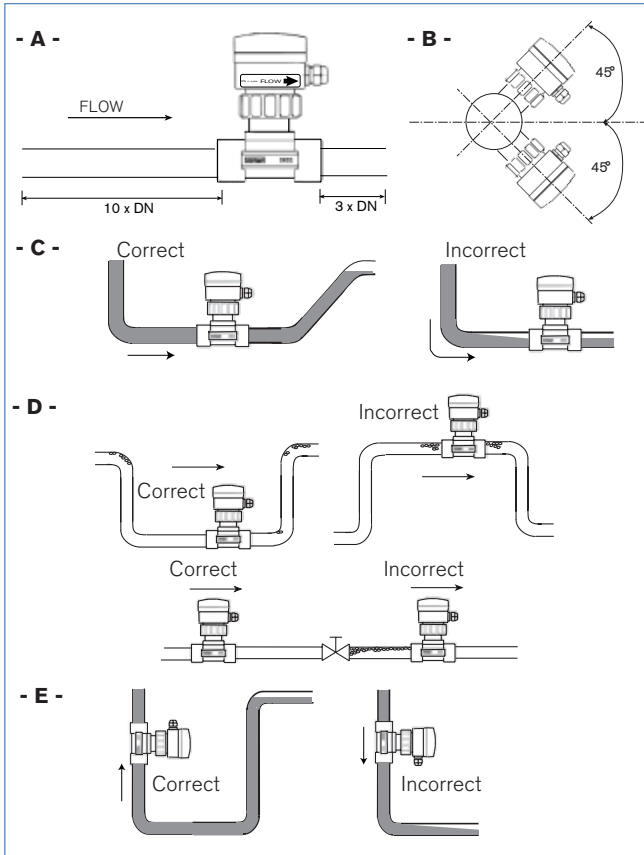

Selection of fitting / pipe size

Example 1:

Specification of nominal flow: 10 m³/h
 - Ideal flow velocity: 2...3m/s
 - For these specifications, the diagram indicates a pipe size of DN 40

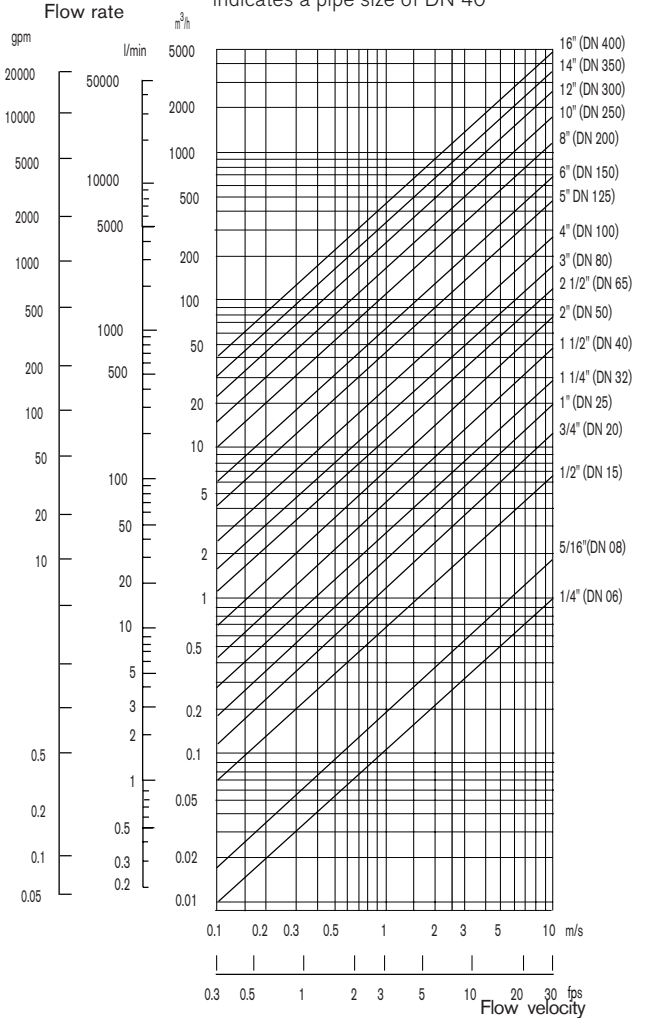

DTS 1000079057 EN Version: - Status: RL (released | freigegeben | validé) printed: 12.08.2008

Dimensions [mm]

Technical drawings show the transmitter's dimensions: 180 mm width, 91 mm height, 218 mm total height, 181 mm body height, 113 mm electrode height, 123 mm body height, 88 mm width, 116 mm width, and 88 mm height. A table provides dimensions for different pipe sizes (DN).

DN [mm]	T-Fitting	H [mm]		
		Saddle	Plastic Spigot	St:St. Spigot
6	181			
8	181			
15	186			
20	183			
25	183			
32	187			
40	191			187
50	197	221		192
65	197	220	202	196
80		224	207	203
100		229	214	213
110		225		
125		232		224
150		242	260	235
180		266		
200		278	281	256
250			299	
300			304	
350			324	
400			338	

Ordering chart for transmitter 8045 - for fitting Type S020 (see corresp. datasheet)

Voltage supply	Output	Relays	Housing material	Gasket	Sensor	Connector	Item no.
18-36 VDC	4-20 mA, pulse	No	PC	FPM	Short, PVDF	2 cable glands M20x1.5	426 498
					Long, PVDF	2 cable glands M20x1.5	426 499
		2	PC	FPM	Short, PVDF	2 cable glands M20x1.5	426 506
					Long, PVDF	2 cable glands M20x1.5	426 507
	No	PPA	EPDM	Short, Stainless steel	2 cable glands M20x1.5	449 670	
				Long, Stainless steel	2 cable glands M20x1.5	449 672	
		2	PPA	EPDM	Short, Stainless steel	2 cable glands M20x1.5	449 671
					Long, Stainless steel	2 cable glands M20x1.5	449 673

Note: Delivered with 1 set 551 775

Ordering chart of accessories for transmitter 8045 (to be ordered separately)

Accessories	Item no.
Set with 2 cable glands M20x1.5 + 2 neoprene flat seals for cable gland or plug + 2 screw-plugs M20x1.5 + 2 multiway seals 2x6 mm	449 755
Set with 2 reductions M20x1.5/NPT1/2" + 2 neoprene flat seals for cable gland or plug + 2 screw-plugs M20x1.5	551 782
Set with 1 stopper for not used cable gland M20x1.5 + 1 multiway seal 2x6 mm for cable gland or plug + 1 black EPDM gasket for the sensor + 1 mounting instruction sheet	551 775
Ring	619 205
PC nut	619 204
PPA nut	440 229
Set with 1 green FPM + 1 black EPDM gaskets	552 111
Calibration certificate	550 676
FDA -Approval	449 788

Interconnection with other Burkert products

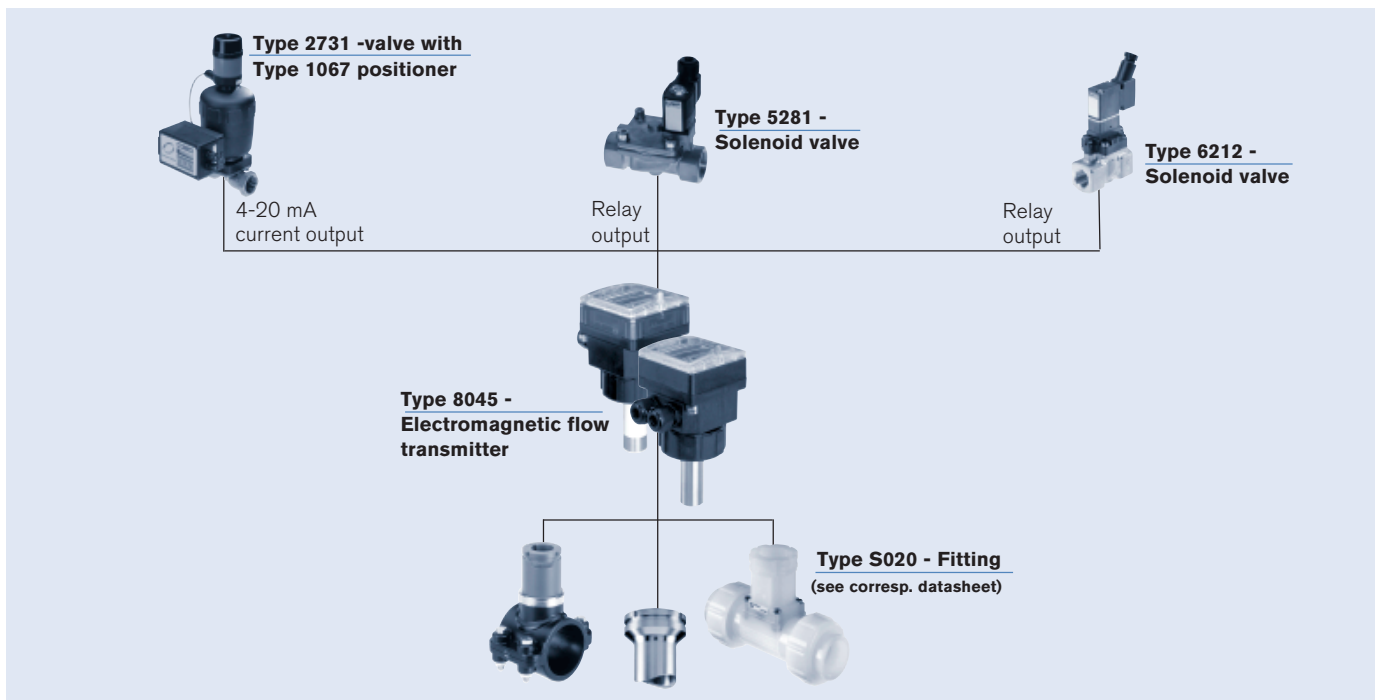

In case of special application conditions, please consult for advice.

We reserve the right to make technical changes without notice.

US_8045_1/05_C