

Selection table for safety switch TK with guard locking (without protection against unintentional closing)

Release feature				
HE	Mechanical release on the switch head			
	Guard locking pin			
	A	C	Right	
			Left	
			Connection	
			M	Thread M20x1.5 for cable gland

Release feature	Guard locking pin		Connection	Page
HE	A	C	M	
●	●		●	70
●		●	●	71

Safety switch TK with guard locking (without protection against unintentional closing)



- ▶ Mounting on plastic housing TP with actuating head and guard locking pin made of metal
- ▶ High locking forces of well above 5000 N
- ▶ Mechanical release on the switch head
- ▶ Actuating element for auxiliary shutdown on front
- ▶ Cable entry M20 x 1.5



Function

Guard locking is by movement of the locking pin, which is inserted in a "recess".

Mechanical release

This releases the guard locking after operation with a triangular key (DIN 22417). Triangular key see accessories on page 91.

Auxiliary shutdown feature

When actuated, positively driven NC contacts 21-22 or 41-42 are opened. The safety guard remains locked. The auxiliary shutdown feature must be sealed to prevent tampering (for example with sealing lacquer).

Solenoid operating voltage

- AC/DC 24 V +10%, -15%
- AC 110 V +10%, -15%
- AC 230 V +10%, -15%

Guard locking types

- TK1** Closed-circuit current principle, guard locking by spring force. Release by applying voltage to the interlocking solenoid.
- TK2** Open-circuit current principle, guard locking by applying voltage to the interlocking solenoid. Release by spring force.

Switching elements

- **528** Slow-action switching element 1 NC ⊖ + 1 NO
- **4131** Slow-action switching element 2 NC ⊖ + 2 NO

Ordering table

Series	Connection	Guard locking	Switching element	Version	Solenoid operating voltage		
					AC/DC 24 V	AC 110 V	AC 230 V
TK	M Cable entry 3 x M20 x 1.5	1 Mechanical	528 1 NC ⊖ + 1 NO	A Guard locking pin right	094 652 TK1-528AB024M	-	-
			4131 2 NC ⊖ + 2 NO	A Guard locking pin right	099 686 TK1-4131AB024M	-	-
		2 Electrical	4131 2 NC ⊖ + 2 NO	A Guard locking pin right	099 690 TK2-4131AB024M	-	-

Cable entry M20 x 1.5
Guard locking pin right

Dimension drawing

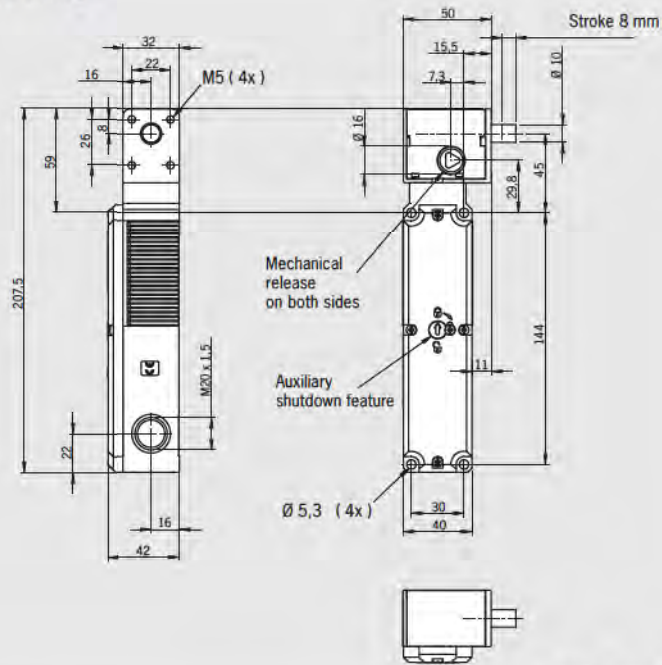

Wiring diagrams Switch locked

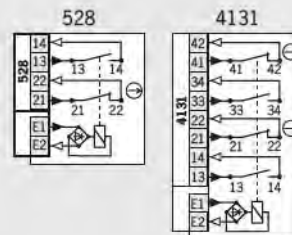

For switching functions see technical data on page 121



Cable entry M20 x 1.5
Guard locking pin left

Dimension drawing

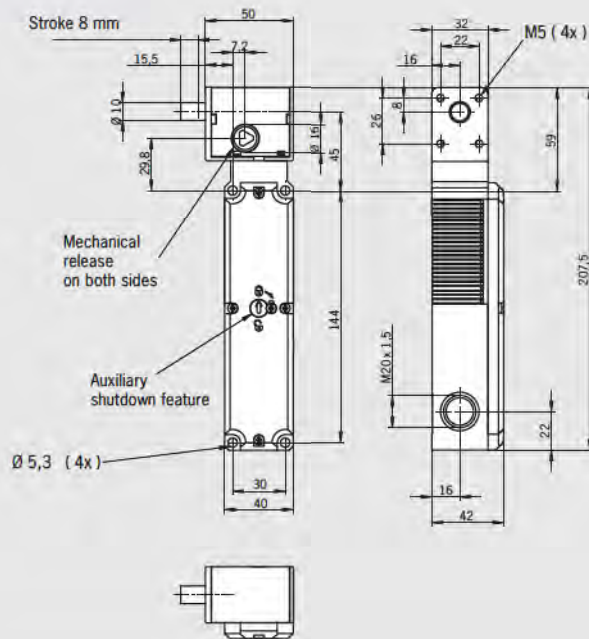

For cable glands see page 89

Wiring diagrams Switch locked

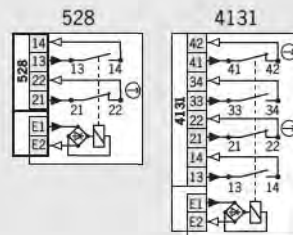

For switching functions see technical data on page 121

Ordering table

Series	Connection	Guard locking	Switching element	Version	Solenoid operating voltage		
					AC/DC 24 V	AC 110 V	AC 230 V
TK	M Cable entry 3 x M20 x 1.5	1 Mechanical	528 1 NC ⊖ + 1 NO	C Guard locking pin left	094 192 TK1-528CB024M	-	100 016 TK1-528CB230M
			4131 2 NC ⊖ + 2 NO	C Guard locking pin left	099 687 TK1-4131CB024M	-	-
		2 Electrical	4131 2 NC ⊖ + 2 NO	C Guard locking pin left	099 691 TK2-4131CB024M	-	-

For safety precautions see page 136
For technical data see page 99





Safety switch TK... with guard locking (without protection against unintentional closing)



The technical data on switches, switching elements and guard locking apply to all connections. Further technical data are given for the connection selected.

Switch			Value	Unit
Parameter	Housing		Reinforced thermoplastic	
	Actuating head		Metal	
	Guard locking pin		Metal	
Mechanical life			1 x 10 ⁶ operating cycles	
Ambient temperature			- 20 ... + 55	°C
Weight			approx. 0.6	kg
Retention force			5	N
Locking force (when fitted on switch head)			5000	N

Switching element			Value	Unit
Switching principle			Slow-action switching element	
Switching elements with 2 switching elements			528 1 NC \ominus + 1 NO	
Switching elements with 4 switching elements			4131 2 NC \ominus + 2 NO	
Switching current, min., at 24 V			1	mA
Switching voltage, min., at 10 mA			12	V
Contact material			Silver alloy, gold flashed	

Guard locking		 	Value	Unit
Solenoid operating voltage			AC/DC 24 V +10/-15%	
Connection			Reverse polarity protected, integrated bridge rectifier	
Duty cycle ED			100	%
Power consumption			8	W

Connection, cable entry M20 x 1.5			Value	Unit
Connection			Screw terminal	
Version			M20 x 1.5	
Conductor cross-section max.			0.34 ... 1.5	mm ²
Degree of protection according to IEC 60529			IP 67	
Rated impulse withstand voltage U _{imp}			2.5	kV
Rated insulation voltage U _i			250	V AC/DC
Conventional thermal current I _{th}			4	A
Short circuit protection according to IEC 60269-1 (control circuit fuse)			4	A gG
Utilization category to IEC 60947-5-1	AC15		I _e 4 A U _e 230 V	
	DC13		I _e 4 A U _e 24 V	

Switching functions TK

Locked

Not locked

