

# Interlocking solenoid safety switches with metal body

## SLM

Protection class IP 67



Machines, which have a "run down time" after they have been switched off, are often part of automatic production processes.

Safety devices should prevent access by the operator and must be kept locked until the dangerous movement has stopped. The safety-position switch (with suitable control) will ensure that safety guards, doors and other covers are kept closed as long as there is danger.

The safety switch has three main functions:

- Allowing the machine to operate while the guard is closed and locked
- Isolating the machine when the guard is open
- Monitoring the position of the guard and the actuator (open or closed)

With the safety switch SLM the user has a position switch with separate actuator and built in locking device, which meets the criteria of interlocking devices, according to EN 1088, the EN 292 part 1 and 2 are also valid since 01.01.1995 complying to the necessary machine guide-lines.

### System description

The safety switch SLM with lock is available in spring and solenoid interlocking design. The separate actuator is securely mounted to the closing guard. When the actuator is inserted into the switch the guard door position is then monitored and either locked or released (dependant on control system/status of machine).

The separate actuator provides a very high level of "operator interference" protection because of its triple coding.

The locking device in the safety switch SLM is integrated into the switch housing. In the spring latch version locking is achieved with a spring mechanism, in the solenoid latch version locking is achieved by energizing an electromagnet. Both types link the actuator with a switch mechanism for position indication.

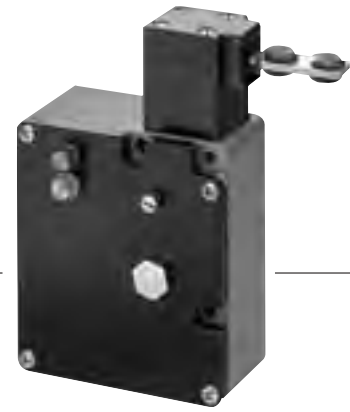

### Benefits of this system

- All elements are enclosed in one metal housing
- High resistance to heavy industrial use
- Compact housing for space saving installation
- Triple coded actuator with high interference protection
- Simple alteration of actuator approach direction in 90° positions (adjust only with actuator fitted)
- All switch functions enclosed in inner module
- Safe and easy wiring due to terminals in separate connection area.
- Individual contact configurations possible
- Integrated safety circuit protects against voltage peaks and incorrect termination
- Mounting with M 5 screws according to DIN EN 50041
- Construction design according to VDE 0660 part 200 IEC 947-5-1 control principles GS-ET 19 of the (German) employer's liability insurance association
- Certification: UL & CSA
- Approval: BG

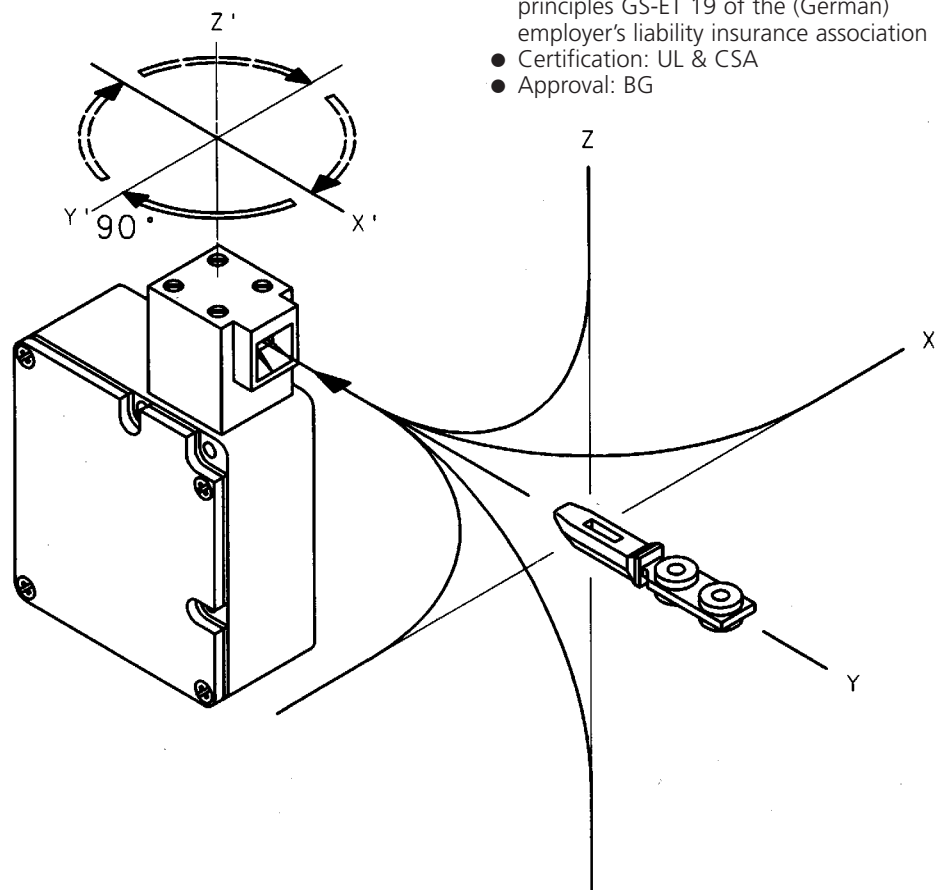

### Important note:

The actuator head position may only be changed with the actuator inserted.

### Locking systems

SLM metal-bodied safety switches with separate actuators are available with spring locking as well as solenoid locking.

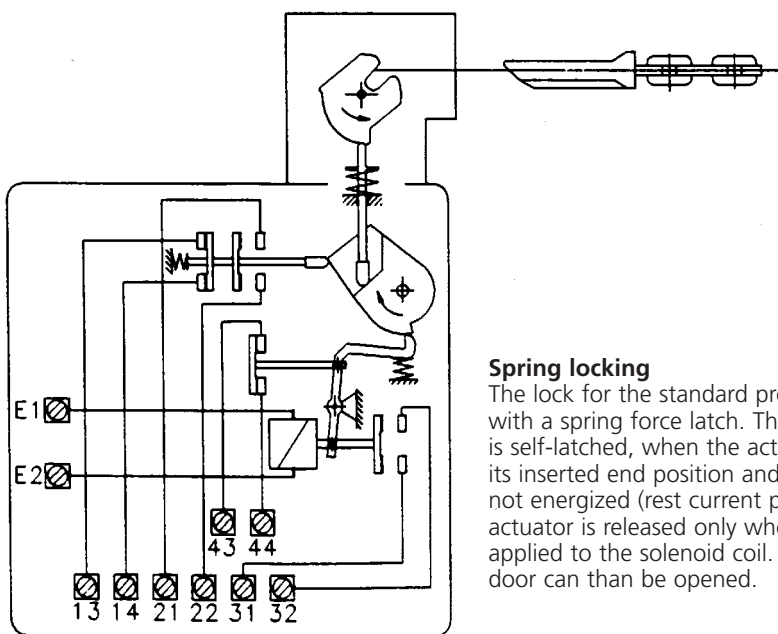

#### Spring locking

The lock for the standard product operates with a spring force latch. The safety device is self-latched, when the actuator reaches its inserted end position and the solenoid is not energized (rest current principle). The actuator is released only when current is applied to the solenoid coil. The guard door can then be opened.

### Options

- Individual contact configurations possible
- Radius actuator for actuating radius lower than 400 mm
- Auxiliary unlock
- Key override
- Emergency stop override
- Visual indication of operating status of the guard and lock
- Actuator for operating with head rotated 180° from standard
- Customised solutions

#### Important note:

Safety switch model SLM with emergency stop override must be installed **inside** the guarded (dangerous) area. The emergency stop should only be able to be activated to ensure escape from a dangerous area in case of a system error.

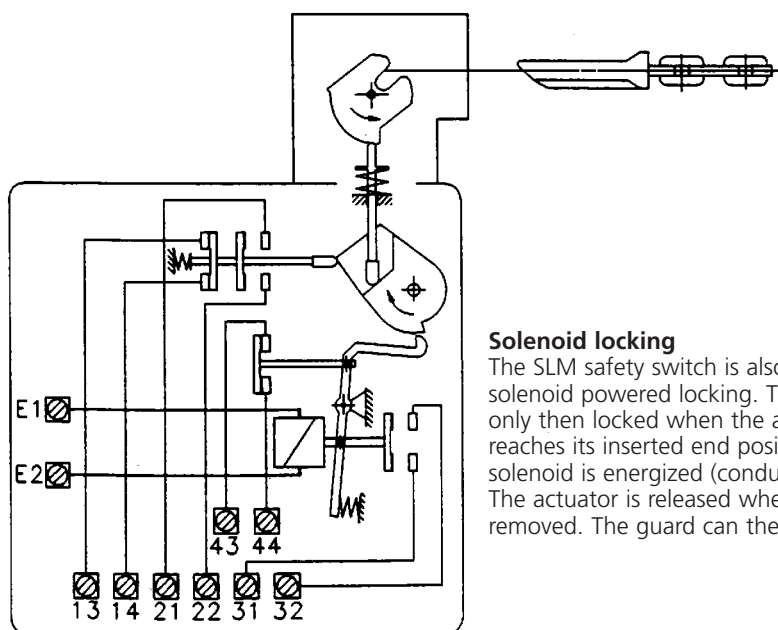

#### Solenoid locking

The SLM safety switch is also available with solenoid powered locking. The guard is only then locked when the actuator reaches its inserted end position and the solenoid is energized (conducting). The actuator is released when power is removed. The guard can then be opened.

## Interlocking solenoid safety switch SLM selection table: standard models

Type	Locking type		Actuator head	Operating voltage							Contact type: Actuator (guard) position			Contact type: Solenoid status		
	Spring locking	Solenoid locking		12 V DC	24 V DC	24 V AC	24 V UC	48 V AC	120 V AC	230 V AC	1NC	2NC	1NC 1NO	1NC	2NC	1NC 1NO
SLM			VTW													
●	●	-	●	-	●	-	-	-	-	-	-	-	●	-	-	●
●	●	-	●	-	-	-	-	-	●	-	-	-	●	-	-	●
●	●	-	●	-	-	-	-	-	-	●	-	-	●	-	-	●
●	●	-	●	-	●	-	-	-	-	-	-	-	●	●	-	-
●	●	-	●	-	-	-	-	-	-	●	-	-	●	-	-	●
●	●	-	●	-	-	-	-	-	-	●	-	-	●	-	-	●
●	●	-	●	-	-	-	-	-	-	●	-	-	●	-	-	●
●	●	-	●	-	-	-	-	-	-	●	-	-	●	-	-	●
●	●	-	●	-	-	-	-	-	-	●	-	-	●	-	-	●
●	●	-	●	-	-	-	-	-	-	●	-	-	●	-	-	●
●	-	●	●	-	●	-	-	-	-	-	-	-	●	-	-	●
●	-	●	●	-	-	-	-	-	●	-	-	-	●	-	-	●
●	-	●	●	-	●	-	-	-	-	-	-	-	●	●	-	-
●	-	●	●	-	-	-	-	-	-	●	-	-	●	●	-	-

### Description/Reference

SLM	F	M	VTW	12 DC	24 DC	24 DC	24 UC	48 AC	120 AC	230 AC	1	2	5	1	2	5	
●	●	-	●	○	○	○	○	●	○	○	○	○	●	○	●	○	○

### Example for Type description: Spring lock mechanism (F)

●	●	-	●	○	○	○	○	●	○	○	○	○	●	○	●	○	○
---	---	---	---	---	---	---	---	---	---	---	---	---	---	---	---	---	---

### Example for Type description: Solenoid lock mechanism (M)

●	-	●	●	●	○	○	○	○	○	○	○	○	○	●	○	○	○
---	---	---	---	---	---	---	---	---	---	---	---	---	---	---	---	---	---

- Standard functions
- Technically possible function combination
- Not available

Auxiliary unlock function				Additional functions	Additional functions	Additional functions	Additional functions	Additional functions	Designation	Part number	Page
– without	AR Auxiliary unlock	KR Key override	ER Emergency stop override								
–	●	–	–	–	–	–	–	–	SLM-FVTW 24DC-55-AR	<b>601.7119.020</b>	82
–	●	–	–	–	–	–	–	–	SLM-FVTW 120AC-55-AR	<b>601.7119.032</b>	82
–	●	–	–	–	–	–	–	–	SLM-FVTW 230AC-55-AR	<b>601.7119.022</b>	83
–	●	–	–	–	–	–	–	–	SLM-FVTW 24DC-51-AR	<b>601.7119.028</b>	83
–	●	–	–	–	–	–	–	–	SLM-FVTW 230AC-51-AR	<b>601.7119.029</b>	83
–	–	●	–	–	–	–	–	–	SLM-FVTW 230AC-55-KR	<b>601.7119.057</b>	84
–	–	–	● *)	–	–	–	–	–	SLM-FVTW 230AC-55-ER	<b>601.7119.058</b>	84
–	●	–	–	●	–	–	–	–	SLM-FVTW 120AC-55-ARL	<b>601.7119.051</b>	85
–	●	–	–	–	–	–	–	●	SLM-FVTW 230AC-55-AR180	<b>601.7119.060</b>	85
●	–	–	–	–	–	–	–	–	SLM-MVTW 24DC-55	<b>601.7119.023</b>	86
●	–	–	–	–	–	–	–	–	SLM-MVTW 120AC-55	<b>601.7119.033</b>	86
●	–	–	–	–	–	–	–	–	SLM-MVTW 230AC-55	<b>601.7119.024</b>	87
●	–	–	–	–	–	–	–	–	SLM-MVTW 24DC-51	<b>601.7119.030</b>	87
●	–	–	–	–	–	–	–	–	SLM-MVTW 230AC-51	<b>601.7119.031</b>	87
–	AR	KR	ER	L	R	S	A	180			
–	○	●	○ *)	○	○	●	○	○	SLM-FVTW 48AC-21-KRS	<b>on request</b>	
●	–	–	○ *)	○	●	○	○	○	SLM-MVTW 12DC-22-R	<b>on request</b>	

\*) Important note: Safety switch model SLM with emergency stop override must be installed **inside** the guarded (dangerous) area. The emergency stop should only be able to be activated to ensure escape from a dangerous area in case of a system error.

# Interlocking solenoid safety switch – spring force version –

## SLM

Protection class IP 67



Designation	SLM-FVTW 24DC-55-AR	SLM-FVTW 120AC-55-AR
<b>Part number</b>	<b>601.7119.020</b>	<b>601.7119.032</b>
Circuit diagram		
⊕ Forced disconnect to IEC 947-5-1 chapter 3		
Za: not galvanically separated contacts		
Zb: galvanically separated contacts		
Slow make & break/snap-action		
Internal seal (iw)/external seal (w)		

⊕ Zb	⊕ Zb	⊕ Zb	⊕ Zb
●/-	●/-	●/-	●/-
1000 N	1000 N	1000 N	1000 N

⊕ Zb	⊕ Zb	⊕ Zb	⊕ Zb
●/-	●/-	●/-	●/-
1000 N	1000 N	1000 N	1000 N

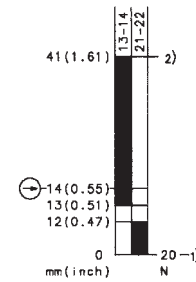
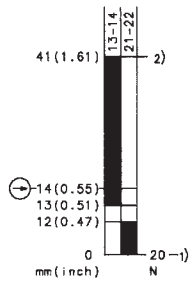
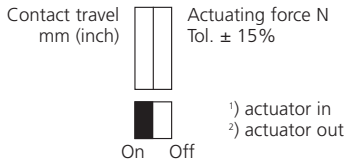



Voltage	max.	250 V
Permanent current	max.	10 A
In-rush current complies with standards IEC 947-5-1 AC 15/DC 13		
Mechanical life – number of switching actions		1 x 10 <sup>6</sup>
Operating temperature	min./max.	-30 °C/+60 °C -22 °F/+140 °F
Approvals		BG, UL, CSA
Weight		0.81 kg/1.79 lb
Delivery: ex-stock/built to order		●/-

Voltage	max.	250 V
Permanent current	max.	10 A
In-rush current complies with standards IEC 947-5-1 AC 15/DC 13		
Mechanical life – number of switching actions		1 x 10 <sup>6</sup>
Operating temperature	min./max.	-30 °C/+60 °C -22 °F/+140 °F
Approvals		BG, UL, CSA
Weight		0.81 kg/1.79 lb
Delivery: ex-stock/built to order		●/-

Voltage	max.	250 V
Permanent current	max.	10 A
In-rush current complies with standards IEC 947-5-1 AC 15/DC 13		
Mechanical life – number of switching actions		1 x 10 <sup>6</sup>
Operating temperature	min./max.	-30 °C/+60 °C -22 °F/+140 °F
Approvals		BG, UL, CSA
Weight		0.81 kg/1.79 lb
Delivery: ex-stock/built to order		●/-

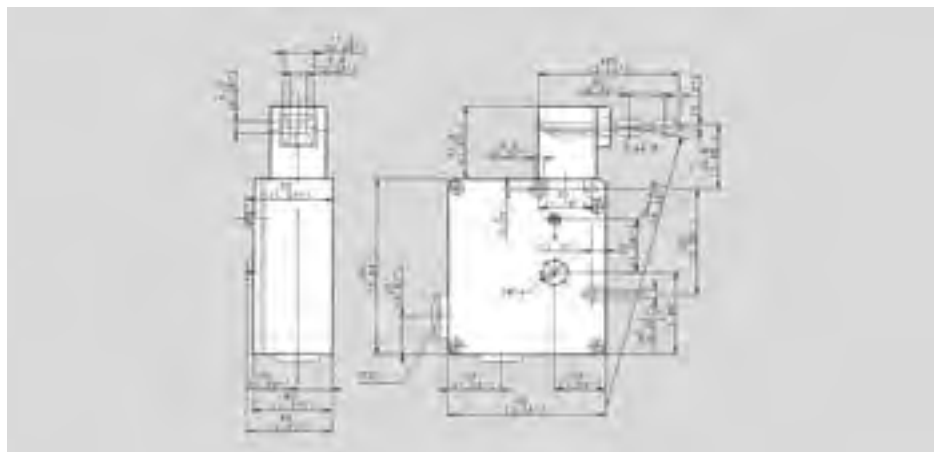
All dimensions in mm (inch)

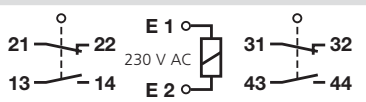

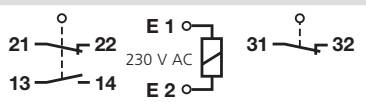
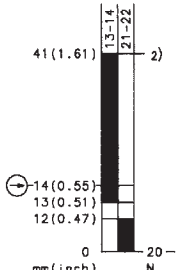
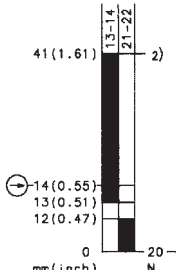
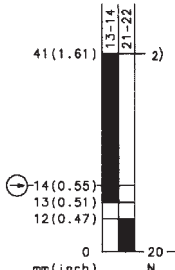
SLM-FVTW 230AC-55-AR 601.7119.022	SLM-FVTW 24DC-51-AR 601.7119.028	SLM-FVTW 230AC-51-AR 601.7119.029
 <p>⊖ Zb ●/-</p> <p>1000 N</p>	 <p>⊖ Zb ●/-</p> <p>1000 N</p>	 <p>⊖ Zb ●/-</p> <p>1000 N</p>
 <p>250 V</p> <p>10 A</p> <p>●</p> <p>1 x 10<sup>6</sup></p> <p>-30 °C/+60 °C</p> <p>-22 °F/+140 °F</p> <p>BG, UL, CSA</p> <p>0.81 kg/1.79 lb</p> <p>●/-</p>	 <p>250 V</p> <p>10 A</p> <p>●</p> <p>1 x 10<sup>6</sup></p> <p>-30 °C/+60 °C</p> <p>-22 °F/+140 °F</p> <p>BG, UL, CSA</p> <p>0.81 kg/1.79 lb</p> <p>-●</p>	 <p>250 V</p> <p>10 A</p> <p>●</p> <p>1 x 10<sup>6</sup></p> <p>-30 °C/+60 °C</p> <p>-22 °F/+140 °F</p> <p>BG, UL, CSA</p> <p>0.81 kg/1.79 lb</p> <p>-●</p>

# Interlocking solenoid safety switch – spring force version –

## SLM

Protection class IP 67



Designation	SLM-FVTW 230AC-55-KR
<b>Part number</b>	<b>601.7119.057</b>
Circuit diagram	
⊕ Forced disconnect to IEC 947-5-1 chapter 3	
Za: not galvanically separated contacts	
Zb: galvanically separated contacts	
Slow make & break/snap-action	
Internal seal (iw)/external seal (w)	

Designation	SLM-FVTW 230AC-55-ER
<b>Part number</b>	<b>601.7119.058</b>
Circuit diagram	
⊕ Zb	⊕ Zb
●/-	●/-
1000 N	1000 N

Designation	SLM-FVTW 230AC-55-ER
<b>Part number</b>	<b>601.7119.058</b>
Circuit diagram	
⊕ Zb	⊕ Zb
●/-	●/-
1000 N	1000 N

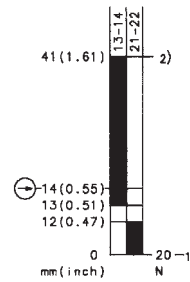
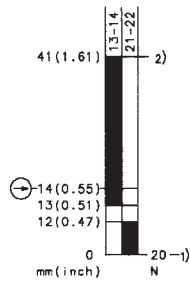
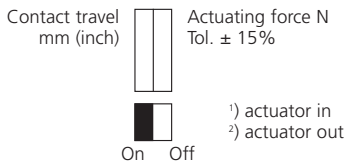

Voltage	max.
Permanent current	max.
In-rush current complies with standards IEC 947-5-1 AC 15/DC 13	
Mechanical life – number of switching actions	1 x 10 <sup>6</sup>
Operating temperature	min./max. -30 °C/+60 °C -22 °F/+140 °F
Approvals	BG, UL, CSA
Weight	0.88 kg/1.49 lb
Delivery: ex-stock/built to order	●/-

Voltage	max. 250 V
Permanent current	max. 10 A
In-rush current complies with standards IEC 947-5-1 AC 15/DC 13	
Mechanical life – number of switching actions	1 x 10 <sup>6</sup>
Operating temperature	min./max. -30 °C/+60 °C -22 °F/+140 °F
Approvals	BG, UL, CSA
Weight	0.94 kg/2.08 lb
Delivery: ex-stock/built to order	●/-

Voltage	max. 250 V
Permanent current	max. 10 A
In-rush current complies with standards IEC 947-5-1 AC 15/DC 13	
Mechanical life – number of switching actions	1 x 10 <sup>6</sup>
Operating temperature	min./max. -30 °C/+60 °C -22 °F/+140 °F
Approvals	BG, UL, CSA
Weight	0.94 kg/2.08 lb
Delivery: ex-stock/built to order	●/-

All dimensions in mm (inch)

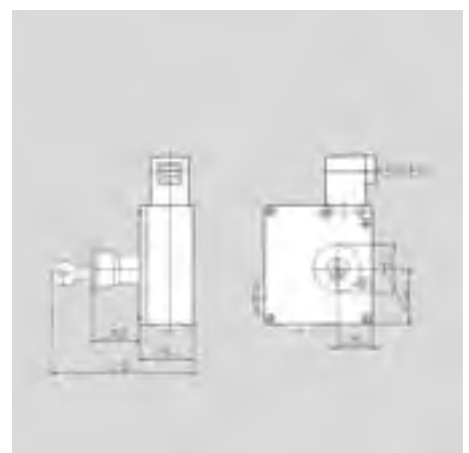
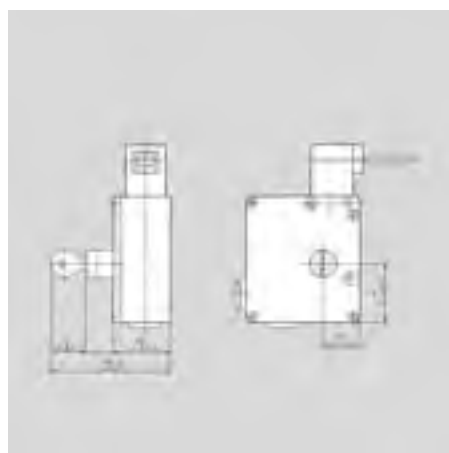



SLM-FVTW 120AC-55-ARL

601.7119.051

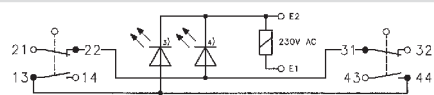

⊖ Zb                      ⊖ Zb  
●/-                        ●/-

1000 N

SLM-FVTW 230AC-55-AR180

601.7119.060

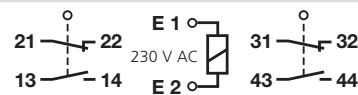

⊖ Zb                      ⊖ Zb  
●/-                        ●/-

1000 N

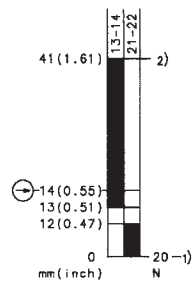

250 V

10 A



1 x 10<sup>6</sup>

-30 °C/+60 °C

-22 °F/+140 °F

BG, UL, CSA

0.83 kg/1.83 lb

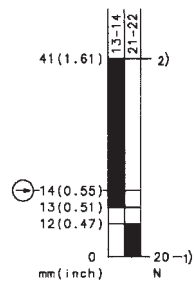

250 V

10 A



1 x 10<sup>6</sup>

-30 °C/+60 °C

-22 °F/+140 °F

BG, UL, CSA

0.83 kg/1.83 lb

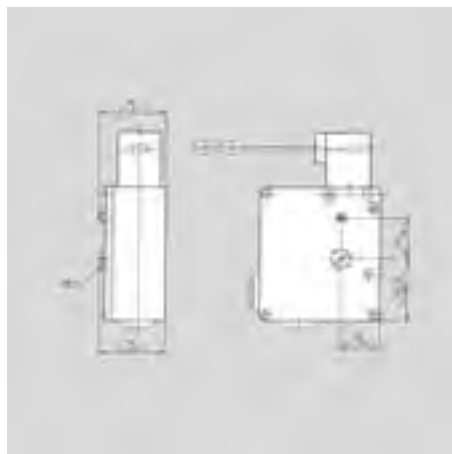
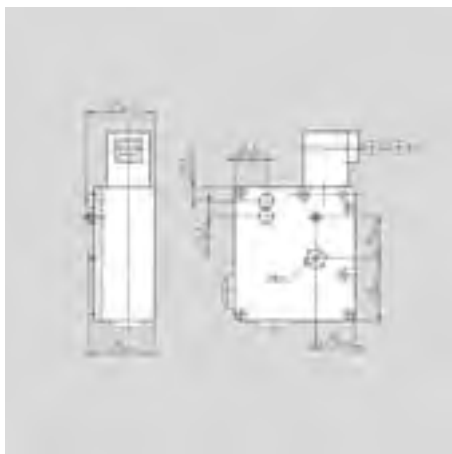



# Metal bodied safety switches with separate actuator and solenoid latch interlocking

## SLM

Protection IP 67



Reference type	SLM-MVTW 24DC-55	SLM-MVTW 120AC-55
<b>Part number</b>	<b>601.7119.023</b>	<b>601.7119.033</b>
Circuit diagram		
⊕ Forced disconnect to IEC 947-5-1 chapter 3		
Za: not galvanically separated contacts		
Zb: galvanically separated contacts		
Slow make & break/snap-action		
Internal seal (iw)/external seal (w)		

⊕ Zb	⊕ Zb	⊕ Zb	⊕ Zb
●/-	●/-	●/-	●/-
1000 N	1000 N	1000 N	1000 N

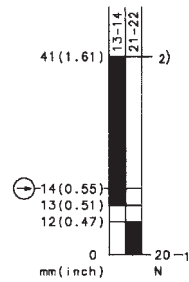
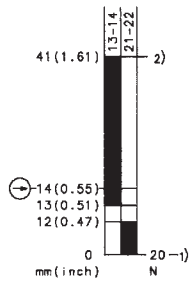
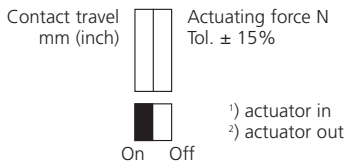

Voltage	max.	250 V
Permanent current	max.	10 A
In-rush current complies with standards IEC 947-5-1 AC 15/DC 13		
Mechanical life – number of switching actions		1 x 10 <sup>6</sup>
Operating temperature	min./max.	-30 °C/+60 °C -22 °F/+140 °F
Approvals		UL, CSA
Weight		BG
Stock status: Ex stock/Built to order		0.81 kg/1.79 lb

Voltage	max.	250 V
Permanent current	max.	10 A
In-rush current complies with standards IEC 947-5-1 AC 15/DC 13		
Mechanical life – number of switching actions		1 x 10 <sup>6</sup>
Operating temperature	min./max.	-30 °C/+60 °C -22 °F/+140 °F
Approvals		UL, CSA
Weight		BG
Stock status: Ex stock/Built to order		0.81 kg/1.79 lb

All dimensions in mm (inch)

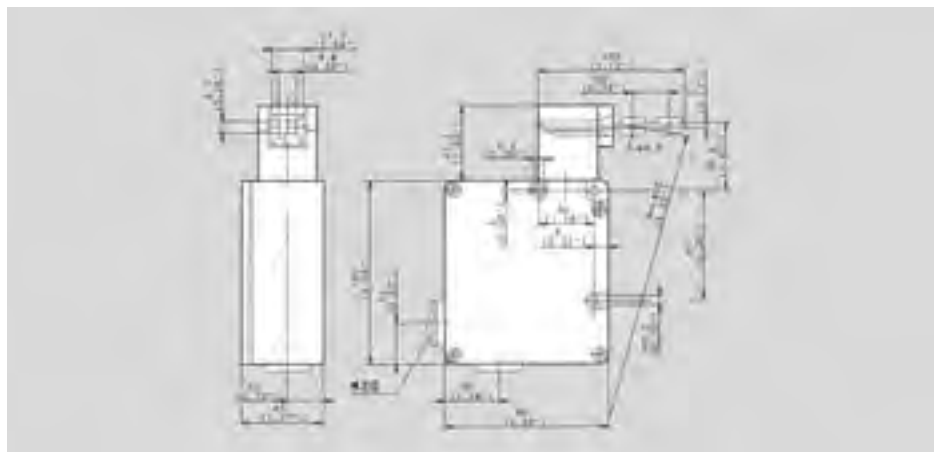

SLM-MVTW 230AC-55

601.7119.024

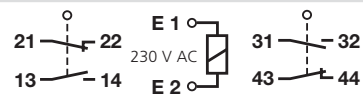

⊖ Zb

⊖ Zb

●/-

●/-

1000 N

SLM-MVTW 24DC-51

601.7119.030



⊖ Zb

⊖ Zb

●/-

●/-

1000 N

SLM-MVTW 230AC-51

601.7119.031

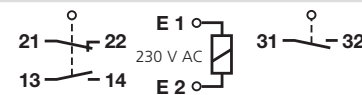

⊖ Zb

⊖ Zb

●/-

●/-

1000 N

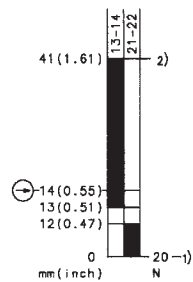

250 V

10 A

●

1 x 10<sup>6</sup>

-30 °C/+60 °C

-22 °F/+140 °F

UL, CSA

BG

0.81 kg/1.79 lb

●/-

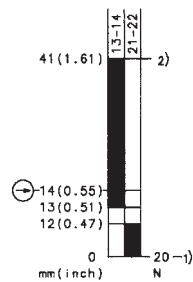

250 V

10 A

●

1 x 10<sup>6</sup>

-30 °C/+60 °C

-22 °F/+140 °F

UL, CSA

BG

0.81 kg/1.79 lb

●/-

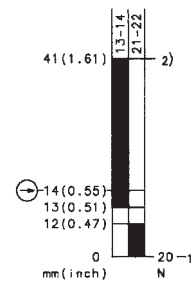

250 V

10 A

●

1 x 10<sup>6</sup>

-30 °C/+60 °C

-22 °F/+140 °F

UL, CSA

BG

0.81 kg/1.79 lb

-/●